

RF Solutions

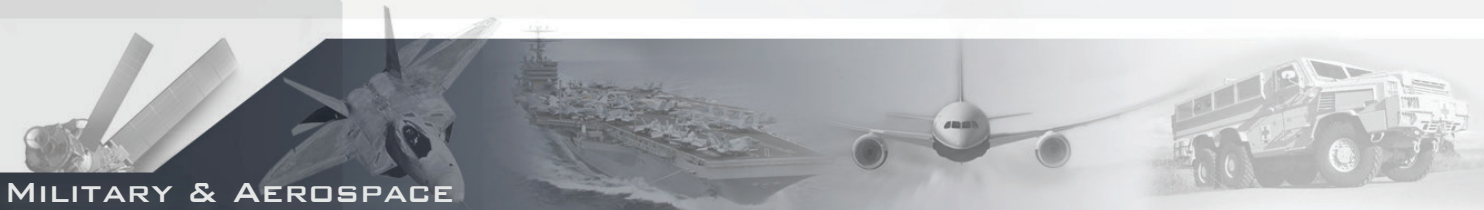

Integrated High Speed Solutions



High Frequency Specialized Interconnects



Standard RF Connectors



Large Form RF Solutions



Coaxial Cables



Antenna Solutions



A diversified product offering of copper contacts for circular and rectangular type connectors supporting a variety of protocols in data rates ranging from 30 MHz to 10Gbps per pair.

Integrated High Speed Solutions



Quadrax 2.5 Gbps



Octonet 8 pin
Quadrax 4 Gbps



Oval Contact
10 Gbps



HSTrip9
14 Gbps

Contact	Size	Speed	Impedance
Coax	12, 16	500-700 MHz	Multiple
Matched Impedance Coax	8, 12	3 GHz	50, 75
Spring Loaded Coax	8, 12, 16	2-65 GHz	50, 75
Concentric Twinax	8, 10, 12	0-30 MHz	Multiple
Triax	8, 10, 12	30-500 MHz	Multiple
Differential Twinax	8, 10D	3 Gbps	100-150
Quadrax 1 st Gen	8	2.5 Gbps	90-150
Quadrax 2 nd Gen	8	6.5 Gbps	100
Oval Contact System	~8	10 Gbps	100

38999

2M

ARINC

MICRO-D

D-SUB

BOARD

CUSTOM



OCS (Oval Contact System) Connectors

OCS Features and Benefits

- High Density: A wide variety of insert arrangements available
- Patterns range from (1) to (21), 100 Ohm differential pairs capable of delivering data transfer speeds of 10Gbps per pair
- MIL-DTL-38999 shell styles available from size 9 to 25
- Front release rear removable contact system for easy repair
- Solder or PCB tail contacts available
- Meets environmental requirements of MIL-DTL-38999
- Uses off-the-shelf Mil Spec backshells

OCS Signal Integrity Performance

- Data rate: 10Gbps per pair
- Insertion loss: <0.3 dB up to 5 GHz
- Return loss: >20 dB up to 5 GHz
- NEXT and FEXT: >40 dB up to 5 GHz
- Differential to common mode conversion: >50 dB up to 5 GHz

Applications for OCS Connectors

High Speed Applications; for use with but not limited to, the following electrical protocols*:

- 10G Base T
- HDMI
- Fibre Channel (AI)
- 40G Base-T
- SATA 2.0, 3.0
- Serial RapidIO
- PCI Express 3.0

* Cable selection may limit data rate of above protocols.



New "Split-Pair" Quadrax Contacts & Cable

Amphenol offers the high performance interconnect solution for CAT6A type cable.

Features and Benefits

- Overall higher bandwidth than standard CAT5E quadrax
- Enhanced crosstalk performance (compared to standard quadrax) due to compatibility with shielded twisted pair of cables
- Can be used for a variety of high speed applications beyond current quadrax design**
- Four strategically spaced inner contacts form two 100 Ohm matched impedance differential pairs
- Outer contact has rugged wall section for durability
- Available in size 8 crimp termination style
- Also available in size 8 PC tails
- Can be installed into existing quadrax contact connector cavities
- Requires modification of MIL-DTL-38999 connector to accommodate keyed contacts

Applications:

For use with, but not limited to, the following electrical protocols:

- 10/100/1000/10GBASE-T Ethernet
- DVI
- USB 2.0
- Serial RapidIO (up to 3.125 Gbps)
- PCI-Express 2.0
- HDMI 1.3a
- SATA 2.0 (up to 3 GHz)



μCom-10Gb +

OCS Features and Benefits

μCom-Series is a new range of connectors designed to address the latest trends of the industry : miniaturization and high speed, with the highest resistance for use in the harshest environments.

μCom-10Gb + is the first product of this new range.

MAIN FEATURES

- 10Gb+ exceeds 10Gb/s Ethernet following IEEE 802.3an-2006 : 10GBase-T
- Cat.6A connector according to TIA568C.2 and ISO/IEC11801 standard
- Environmental testing based on MIL-DTL-38999 series III military specifications
- Miniature : 15 mm(.59”) max external diameter

FEATURES AND BENEFITS

- 4 pairs totally insulated throughout the connector
 - minimum cross-talk between the four pairs
- Patent pending special interfacial shapes
 - minimum perturbation at the interface of each pair
- Thread coupling mechanism
 - 2000 mating cycles & high vibration resistance
- Machined Brass shells and RoHS compliant plating
 - shell to shell continuity and 500h salt spray resistance
- Machined & gold plated Solder and Crimp contacts
 - design & performance according to the innercontact of M39029/77-429#16 M39029/76-425#16 38999 contact
- Solder contact : max AWG24
- Crimp contact : AWG 24 to 26
- IP68 sealing mated and unmated for receptacles
- 1500 Vrms Dielectric Withstanding voltage
- Temperature range : - 55°C / + 125°C



MIL-DTL-38999 with Coaxial, Concentric Twinax, and Triax Connectors

Amphenol Connectors are ideally suited for the incorporation of shielded contacts for high performance interconnection applications. The circular family is built around MIL-DTL-38999 specifications, with Mil-approved and commercial styles offered. Normal operating voltage for circulars with power contacts only is up to 900 VAC (RMS) at sea level.

The MIL-DTL-38999 family offers these features for contact termination flexibility and Widest selection of insert arrangements that can incorporate:

- Size 8 high speed Quadrax and Differential Twinax contacts for MIL-DTL-38999 Series III (specially modified to accommodate keyed contacts)
- Transition adapters for use in attaching D38999 Series III connectors with high speed quadrax or differential contacts to PCB boards
- Size 8, 12 and 16 Coax contacts
- Size 8 and 12 Twinax contacts
- Size 8, 10 & 12 Triax contacts

Wide selection of connector shell styles and sizes:

- Scoop-proof recessed design in LJ-R, TV-R and SJ-R connectors provide protection for contacts
- Standard power contacts are crimp rear release, qualified to SAE AS39029
- Coax, Twinax, and Triax contacts employ the same retention system as power contacts, simplifying user substitution



MIL-DTL-38999 with Coaxial, Differential Twinax, and Quadrx Connectors

- High speed Quadrx contacts consist of an outer contact with four inner contacts spaced to form two 100 or 150 Ohm controlled impedance differential pair.
- Both contacts, when used in Amphenol MIL-DTL-38999 Series III and ARINC type connectors, provide an excellent alternative for harsh environment applications such as:
 - Ethernet 100 Base-T-100 Ohm
 - Gigabit Ethernet 1000 Base-T-100 Ohm
 - Fibre Channel-150 Ohm
 - IEEE1394B FireWire-110 Ohm

Differential Twinax and Quadrx contact options include:

- Crimp or printed circuit board termination
- Established designs to accommodate a variety of cable types and gages
- Ground plane connectors can incorporate quadrx contacts. These connections have conductive inserts that ground the outer conductor of the contact body to the shell of the connector. They accommodate size 8 and 12 shielded contacts of which the size 8 can be quadrx type.



Fiber to Copper Converter

Amphenol offers the Fiber to Copper Converter product line, a flexible, affordable, and rugged fiber copper converter system with many options available. This Amphenol connector will transform your high speed needs to a new level. We have taken two technologies and combined them into a hybrid connector. Now you can transfer high speed data seamlessly from copper to fiber and from fiber to copper.

Features:

- No need for internal subsystem fiber harnesses, interconnect, or transceivers
- Utilizes copper transceivers and existing interconnect (backplane, harnessing, faceplate) for system fiber connection
- Media conversion at the connector reduces system complexity and cost
- APH Epoxy staking protects delicate fiber components for environment and assembly process

Overall Unit Dimensions:

- 13 shell size & flex copper assembly; other shell sizes available

Fiber Interface:

- Jamnut or flange mount
- Shell size 13 38999; options for EPX/ARINC 400/600
- MS29504 system fiber interface; options for expanded beam/ARINC 801/MT
- 2X bi-directional interfaces
- Speeds of 1G, 2G, 4G, 10Gbps
- Interface support for 1/2/4/8G FC and 1/10GbE; option for DVI, SFDP

Copper Interface:

- 2X high speed channels on 6.5 Gbps capable split pair quadrx PC tails or flex assembly
- Interfaces for power, diagnostics, and others



MRC Multi-Media Ruggedized

Amphenol now offers a connector series that can be used for all of your multi-media needs. This series is capable of running Gigabit Ethernet, USB 2.0/USB 3.0, HDMI and 10 Gigabit Ethernet when specified and designated to a specific configuration. MRC is a micro-miniature connector ideal for Commercial, Industrial and Military Communication Systems.

The MRC can be easily cleaned by simply wiping off debris whereas standard pin and socket style connectors tend to be more difficult to remove debris once it has been compacted in the contacts.

The MRC cable assemblies feature connectors with spring loaded contacts and two coupling styles (Push/Pull and Push w/ ¼ turn lock). Both of these coupling styles mate with the standard flange mounting plug. Cable assemblies are available in various lengths and can either be supplied as double ended with MRC connectors on both ends or with standard COTS RJ45, USB, HDMI connections on one end.

MRC Series Specifications

Current Rating	2.5 AMPS Max Per Contact
Protocols Sup - Ported	Gigabit Ethernet, USB 2.0/3.0, 10 Gigabit Ethernet, & HDMI
Durability	2000 Mating Cycles
Unmating Force	15 lb. Min

Materials & Finishes

Shells	Aluminum Alloy
Contacts	Copper Alloy, Gold Plated
Insulators	Polyphenylene Sulfide (PPS), Teflon
Canted Coil Spring	Stainless Steel, Gold Plated



R393 – HIGH SPEED CONNECTORS

Features

- Low Profile and light weight design
- Ideal for maximum number of high speed RF contacts in minimal space
- 38999 size 8 Quadrax, Twinax, Fibre Optic
- Environmental and Filtered options available
- Multiple shell sizes including custom geometry
- Captive Hardware
- Backshells

Applications

- Military and Commercial Avionics
- Cable to Avionics box applications
- Cable to cable applications

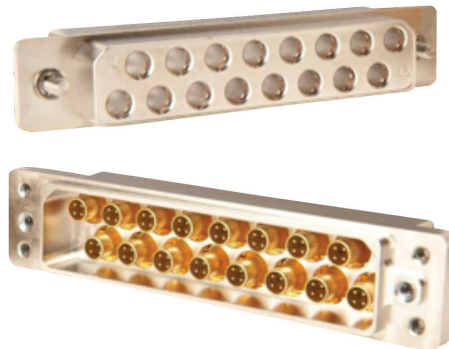

R393 with 16 Quads Custom Rectangular

Environmental R39

Future Combat – NLOS-C, Grommet, Shell Seal, Panel Seal

R393 special w/ Quads Custom Rectangular

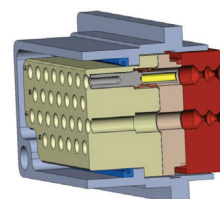



D83 – COMPACT HIGH DENSITY

- One Piece Shell – Sealed Construction
- Available Features – Ground Spring, Blind Mate Hardware, Combo Hybrid Arrangement
- Contact Interface is MIL-C-39029, fixed or crimp terminated

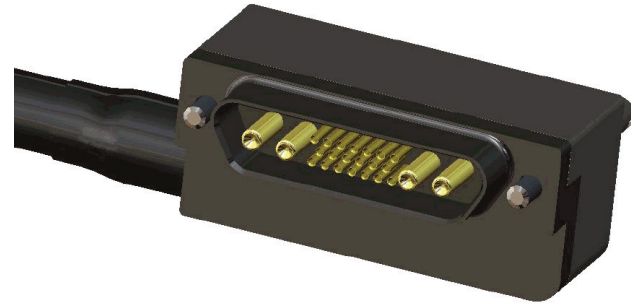

D83 – MICRO RF COAX HIGH DENSITY

- One Piece Shell – Sealed Construction (IP67)
- Available Features – Combo Hybrid Arrangement
- EPDM flange o-ring, PCB tail termination, compliant to NBC ruggedness standards



INTEGRATED RF CONTACTS

Features

- Sealed, one-piece, plated aluminum shell, grounded to panel
- Integrated dual size 8/10 differential twinax / quadrax
- EPDM flange o-ring, PCB tail termination, compliant to NBC ruggedness standards

Connector Basics

- Common ground, integrated dual size 10 twinax d-sub style receptacle, PCB tail termination
- One piece, cadmium plated aluminum shell, grounded to panel
- Sealed, and supplied with mounting jackposts, and EPDM flange o-ring
- Compliant to NBC ruggedness standards

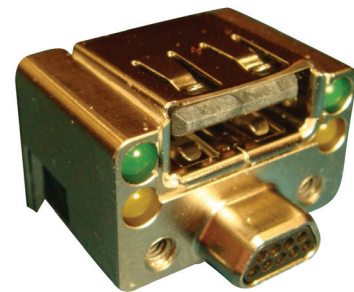

COMBO STACK: MICRO-D + USB

Features

- Smallest Footprint, where size, performance, and functionality are critical
- Integrated USB receptacle (“A” configuration), grounded to shell assembly, with integrated LEDs
- One piece, plated aluminum shell, grounded to panel
- Allows independent mating of micro-D and USB

Applications

- Embedded, Modular Computers

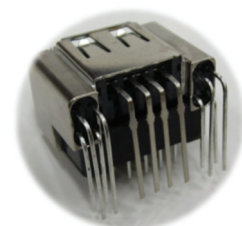

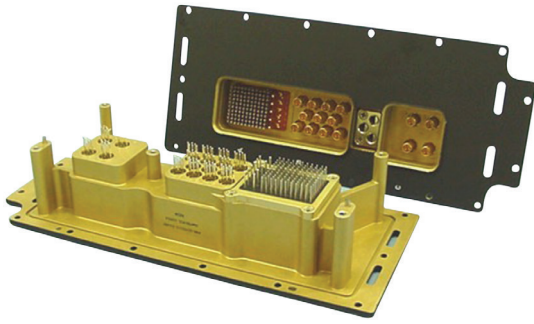

ARINC 600

- Low Insertion Force contacts
- Specified for Hi speed Twinax, Triax, Coax, Quadrax and Fiber optic (M29504 & Arinc 801)
- Available in 3 shell sizes and holds up to 800 contacts
- Environmental and Filtering options available
- Enhanced EMI Shielding to Boeing S280W601
- Intermateable with Commercial and Military versions
- Designed to meet Boeing BACC 66 & ARINC 600 Specifications

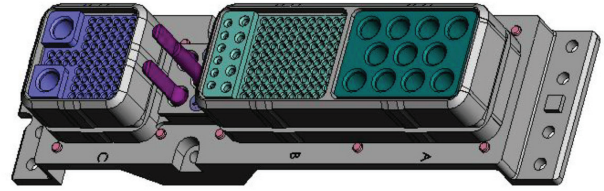

Filtered Arinc 600 with Fiber Optics and Quadrax Contacts

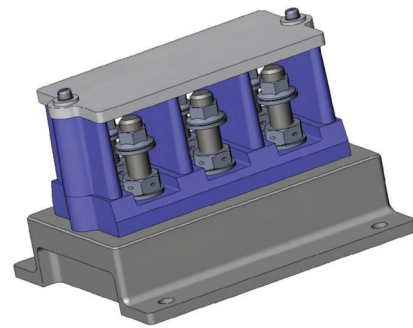

Arinc 600 with Arinc 801 Fiber Optics

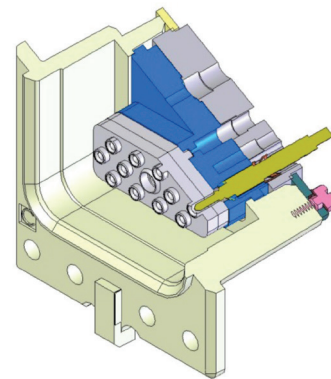
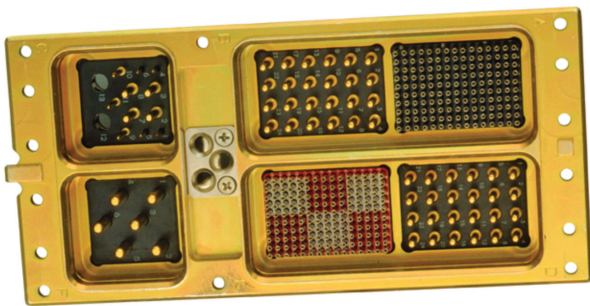

Custom Avionics Connector -787
Wing Engine Breakaway connector

Amphenol® High Frequency Contacts

HF 38999 High Frequency Contacts



FEATURES & BENEFITS

Operating frequency range DC to 40 GHz

Compatible with all Size 8 D38999 Series I & III Inserts

True float mount for optimal performance

APPLICATIONS

Military Communication Terminals

Shipboard and Airborne Systems

Phased Array Radars

High Density Multiport Requirements

Harsh Environment Applications

Amphenol



Focus on high performance RF interconnect
 Great for “inside-the-box” applications for RF signals that transition to PCB for signal processing
 The first coaxial interconnect VITA specification
 Unique retention mechanism offers significant ease of assembly/disassembly over competitor designs

High Frequency Specialized Interconnects

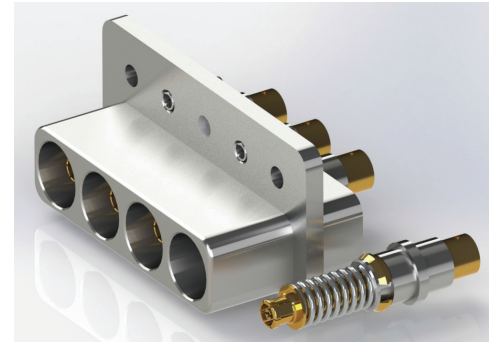

Type	Prefix	Freq (GHz)	VSWR*	DWV**	Coupling	Relative Size
7/16	84	6	1.15:1	4000	Threaded	3 X
1.85mm	33	65	1.60:1	500	Threaded	1 X
2.4mm	16	50	1.40:1	500	Threaded	1 X
2.92mm	15	40	1.34:1	750	Threaded	1 X
3.5mm	92	26.5	1.30:1	500	Threaded	1 X
BMA	17	22	1.15:1	1000	Slide-on	1 X
BMMA	14	28	1.30:1	750	Slide-on	0.75 X
BMZ	89	18	1.20:1	1000	Slide-on	0.75 X
BNC	47	6	1.20:1	1500	Bayonet	1.5 X
BZ	88	2	1.10:1	1500	Slide-on	1.5 X
PN	65	18	1.30:1	3000	Threaded	2.5 X
PTNC	45	18	1.20:1	1500	Threaded	2 X
SC	52	11	1.30:1	3000	Threaded	3 X
SMA	29	18	1.20:1	1000	Threaded	1 X
SMB	23	4	1.10:1	1000	Slide-on	0.5 X
SMC	22	10	1.40:1	1000	Threaded	0.5 X
SMP	12	40	1.40:1	500	Snap-on	0.25 X
SMPM	32	65	1.30:1	325	Snap-on	0.2 X
SMPS	38	100	1.30:1***	250	Snap-on	0.15 X
SSMA	27	36	1.30:1	750	Threaded	0.75 X
SVMS	49	23	1.30:1	1500	Snap-on	1 X
TNC	40	15	1.30:1	1500	Threaded	2 X
TRIAx (BNC)	48	6	1.30:1	1500	Bayonet	2 X
TRIAx (TNC)	48	11	1.30:1	1500	Threaded	2 X
TYPE N	50	12.4	1.30:1	3000	Threaded	2.5 X
ZMA	87	18	1.20:1	1500	Bayonet	1.5 X

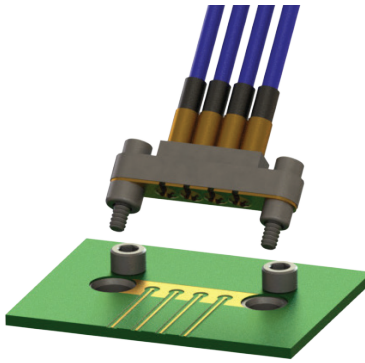
**FeatherMate****Features**

- Zero force to disengage
- 40 GHz frequency range
- .085" [2.16mm] pitch
- 1,000 min mating cycles
- 4 and 8 port available
- CPW/Microstrip or Stripline Launch
- Keying eliminates mismating
- Two cable options
- RoHS Compliant

Applications

- Bench-top testing
- Evaluation boards
- Automated Test Equipment (ATE)
- High density multiports

Benefits

- Zero disengagement eliminates damage to PCB solder joints
- Direct contact with PCB trace for optimal performance
- No custom tooling required
- Solder free installation
- Reflow oven (265°C) safe

**QuarterBack****Features**

- Quarter turn bayonet locking feature on standard SMP/SMPM interface
- Female cable connector options available for all flexible cable types .085" diameter and smaller
- All standard SMP/SMPM male connector options available upon request
- Low VSWR through 40 GHz (SMP) / 65 GHz (SMPM) O: 561.840.1800 marketing@svmicrowave.com

Applications

- Bench-top testing
- High vibration environments
- Applications requiring a high number of mating cycles
- Military and Commercial options available

Benefits

- Zero disengagement eliminates damage to PCB solder joints
- Low insertion/extraction forces, compared to standard full detent SMP and SMPM, mean less torque on board mount connector solder joints during mating and demating
- Spring loaded positive mating feature allows excellent electrical performance even in extreme vibration environments
- Low mating forces allow for more mating cycles without failure compared to full detent SMP and SMPM



VITA 67

Features

- The foundational coaxial interconnect for RF on the VPX platforms
- Cable assembly daughtercard modules that mate to backplane adapters
- Designed for side-by-side implementation with VITA 46 hardware
- Floating SMPM coaxial contacts ensure excellent RF performance in any mating condition
- Available in 3U (4 position) and 6U (8 position) formats

Applications

- Robust and rugged high speed cabled solution
- High-reliability, high-density for aerospace & defense applications
- SIGINT, EWR, ground base station & communication systems, avionics, radar systems
- Air Transport Racks (ATRs) without Rear Transition Modules (RTMs) or limited speed through RTM

Benefits

- MIL-STD 810 for shock and vibration
- Minimal footprint of I/O slot
- Significant reduction in Mean-Time-To-Repair (MTTR) since rear panel interface enables quick disconnect
- Utilizes existing and proven SMPM interfaces
- Unique SV connector retention mechanism offers significant ease of assembly/disassembly



Flextra

Features

- Standard and custom cable options, including SMA, BMA, 2.92 mm, SMP, SMPM, SMPS connectors
- Three unique cable solutions available:
- Standard Flextra - Flexible replacement for Ø.047" semi-rigid
 - Rapid Flextra - Lowest loss Ø.047" flex cable on the market
 - Ultra Flextra - The most flexible Ø.047" flex cable on the market

Applications

- Inside-the-box short cable runs where space is at a premium and tight bends are required
- High frequency applications (up to 100 GHz)
- Dynamic applications requiring low flex resistance

Benefits

- The most flexible cable options available with proven performance at < 0.125" bend radius
- Low solder wicking and high flexibility allows for tight bends behind the cable ferrule
- High flex-life ensures excellent performance after repeated usage



BMA

Government designation BMA (Blindmate A) was developed in the 1980's. The originally designated OSP™ connector by M/A-Com has excellent electrical performance up to 22 GHz in a compact size. SV Microwave offers extended frequencies on most BMA connector designs up to 26.5 GHz. With a slide-on interface and a connector durability of 5000 cycles, the BMA blindmate is suitable for high performance microwave applications.

Electrical Specifications

Impedance	50Ω
Frequency	22 GHz
VSWR	1.02 + .008 f
Insertion Loss	.03 v f
Shielding Effectiveness	≥ -90 - f dB
Dielectric Withstanding Voltage	1000 VRMS

Mechanical Specifications

Mating Cycles	5000
Insertion Force	3.0 lbs
Withdrawal Force	1.5 lbs
Axial Float (Spring Loaded)	.060"
Radial Float (Spring Loaded)	.020"

Environmental Specifications

Temperature Rating	-65°C to +165°C
Corrosion (Salt Spray)	MIL-STD-202, Method 101, Condition B
Vibration	MIL-STD-202, Method 204, Condition D, 20 Gs
Shock	MIL-STD-202, Method 213, Condition I, 100 Gs
Thermal Shock	MIL-STD-202, Method 107. Cond. B, -65°C to +125°C
Moisture Resistance	MIL-STD-202, Method 106, Less Step 7B
Barometric Pressure (Altitude)	MIL-STD-202, Method 105, Condition C, 70k Ft.



Coaxial Contacts

System design and platform needs have required smaller packaging with RF, D/C signal and power all in close proximity. Our proven designs and blindmate technology have enabled the integration of multiport RF signals into single housings for gang mating capability. Various existing form factors such as D38999, ARINC, Micro-D and D-Sub have provided standard components and familiar shell sizes. Hybrid technology fuses RF and D/C contacts into a single connector simplifying design and installation while eliminating discrete wiring.

Electrical Specifications

Impedance	50Ω
Frequency	3 GHz
VSWR	1.20 + .04 f
Insertion Loss	.11 v f
Shielding Effectiveness	≥ -80 dB
Dielectric Withstanding Voltage	250 - 1000 VRMS

Mechanical Specifications

Mating Cycles	500
Insertion Force	30 oz
Withdrawal Force	2 oz

Environmental Specifications

Temperature Rating	-65°C to +165°C
Corrosion (Salt Spray)	MIL-STD-202, Method 101, Condition B
Vibration	MIL-STD-202, Method 204, Condition D, 20 Gs
Shock	MIL-STD-202, Method 213, Condition I, 100 Gs
Thermal Shock	MIL-STD-202, Method 107. Cond. B, -65°C to +125°C
Moisture Resistance	MIL-STD-202, Method 106, Less Step 7B
Barometric Pressure (Altitude)	MIL-STD-202, Method 105, Condition C, 70k Ft.



SMA

SMA is an acronym for SubMiniature version A and was developed in the 1960's. Using a threaded interface, 50 Ohm SMA connectors are precision subminiature units that provide excellent electrical performance from DC to 26.5 GHz. These high-performance connectors are compact in size and mechanically have outstanding durability. Built in accordance with MIL-PRF-39012 and CECC 22110/111, SMA connectors can be mated with all connectors that meet these spec mating diameters regardless of manufacturer.

Electrical Specifications

Impedance	50Ω
Frequency	18 GHz (select models to 26.5 GHz)
VSWR	1.05 + .005 f
Insertion Loss	.03 v f
Shielding Effectiveness	≥ -90 - f dB
Dielectric Withstanding Voltage	1000 VRMS

Mechanical Specifications

Mating Cycles	500
Mating Torque	7 - 10 in - lbs

Environmental Specifications

Temperature Rating	-65°C to +165°C
Corrosion (Salt Spray)	MIL-STD-202, Method 101, Condition B
Vibration	MIL-STD-202, Method 204, Condition D, 20 Gs
Shock	MIL-STD-202, Method 213, Condition I, 100 Gs
Thermal Shock	MIL-STD-202, Method 107. Cond. B, -65°C to +125°C
Moisture Resistance	MIL-STD-202, Method 106, Less Step 7B
Barometric Pressure (Altitude)	MIL-STD-202, Method 105, Condition C, 70k Ft.



2,92 mm

The 2.92mm connector was developed for use to 40 GHz. The male pin is shorter than that of an SMA or 3.5mm to ensure that the outer contacts of the male and female connectors engage before the pin and female receptacle do. This ensures that the pin and socket will not see excessive wear and mating stress seen by misalignment in an SMA or 3.5mm connector. The 2.92mm connector also has a thicker wall than a standard SMA. The 2.92mm series mates with SMA and 3.5mm connectors.

Electrical Specifications

Impedance	50Ω
Frequency	40 GHz
VSWR	1.03 + .005 f
Insertion Loss	.04 v f
Shielding Effectiveness	≥ 100 dB

Mechanical Specifications

Mating Cycles	500
Mating Torque	7 - 10 in - lbs
Inter-mate ability	SMA, 3.5mm

Environmental Specifications

Temperature Rating	-65°C to +165°C
Corrosion (Salt Spray)	MIL-STD-202, Method 101, Condition B
Vibration	MIL-STD-202, Method 204, Condition D, 20 Gs
Shock	MIL-STD-202, Method 213, Condition I, 100 Gs
Thermal Shock	MIL-STD-202, Method 107. Cond. B, -65°C to +125°C
Moisture Resistance	MIL-STD-202, Method 106, Less Step 7B
Barometric Pressure (Altitude)	MIL-STD-202, Method 105, Condition C, 70k Ft.



2,4 mm

The 2.4mm connector was developed for use to 50 GHz. This connector series uses a thick outer wall to eliminate the fragility seen in SMA and 2.92mm connectors. The female socket is also strengthened to ensure reliable mating. The 2.4mm series mates with SMA, 3.5mm and 2.92mm connectors with adapters and can mate with the 1.85mm series without adapters.

Electrical Specifications

Impedance	50Ω
Frequency	40 GHz
VSWR	1.03 + .005 f
Insertion Loss	.04 v f
Shielding Effectiveness	≥ 100 dB

Mechanical Specifications

Mating Cycles	500
Mating Torque	5 - 7 in - lbs
Inter-mate ability	1.85mm

Environmental Specifications

Temperature Rating	-65°C to +165°C
Corrosion (Salt Spray)	MIL-STD-202, Method 101, Condition B
Vibration	MIL-STD-202, Method 204, Condition D, 20 Gs
Shock	MIL-STD-202, Method 213, Condition I, 100 Gs
Thermal Shock	MIL-STD-202, Method 107. Cond. B, -65°C to +125°C
Moisture Resistance	MIL-STD-202, Method 106, Less Step 7B
Barometric Pressure (Altitude)	MIL-STD-202, Method 105, Condition C, 70k Ft.



1,85 mm

The 1.85mm connector was designed for mode free operation through 65 GHz. The interface uses a mostly air-dielectric with a support bead that is set back in the body of the connector to reduce bead interaction in a mated pair. Like the 2.92mm and 2.4mm connector, the body has been designed to ensure that the outer conductors engage before the center conductors make contact. The 1.85mm interface uses an M7 thread and is compatible only with the 2.4mm interface. SV Microwave supplies adapters to mate 1.85mm connectors to SMA and 2.92mm connectors.

Electrical Specifications

Impedance	50Ω
Frequency	65 GHz
VSWR	1.03 + .005 f
Insertion Loss	.04 v f
Shielding Effectiveness	≥ 100 dB

Mechanical Specifications

Mating Cycles	500
Mating Torque	5 - 7 in - lbs
Inter-mate ability	2.4mm

Environmental Specifications

Temperature Rating	-65°C to +165°C
Corrosion (Salt Spray)	MIL-STD-202, Method 101, Condition B
Vibration	MIL-STD-202, Method 204, Condition D, 20 Gs
Shock	MIL-STD-202, Method 213, Condition I, 100 Gs
Thermal Shock	MIL-STD-202, Method 107. Cond. B, -65°C to +125°C
Moisture Resistance	MIL-STD-202, Method 106, Less Step 7B
Barometric Pressure (Altitude)	MIL-STD-202, Method 105, Condition C, 70k Ft.



SMP

SV Microwave offers a complete line of SMP connectors that conform to DSCC 94007, 94008 and MIL-STD-348. The SMP connector was developed to meet an industry need for a smaller high frequency compact design that incorporated ease of use and functionality. The SMP bullet is the heart of this unique design.

Electrical Specifications

Impedance	50Ω
Frequency	40 GHz
VSWR	1.15:1 to 26.5 GHz typ.; 1.5:1 to 40 GHz typ.
Insertion Loss	.06 v f
Shielding Effectiveness	≥ -80 dB DC - 3 GHz; ≥ -65 dB 3 - 26.5 GHz
Dielectric Withstanding Voltage	500 VRMS

Mechanical Specifications

	SB	LD	FD
Mating Cycles	1000	500	100
Force to Engage/Disengage	3.0 / 0.5 lbs	5.0 / 7.0 lbs	7.0 / 9.0 lbs
Axial Misalignment	.010"		
Radial Misalignment	± .010"		

Environmental Specifications

Temperature Rating	-65°C to +165°C
Corrosion (Salt Spray)	MIL-STD-202, Method 101, Condition B
Vibration	MIL-STD-202, Method 204, Condition D, 20 Gs
Shock	MIL-STD-202, Method 213, Condition I, 100 Gs
Thermal Shock	MIL-STD-202, Method 107. Cond. B, -65°C to +165°C
Barometric Pressure (Altitude)	MIL-STD-202, Method 105, Condition C, 70k Ft.



SMPM

SV Microwave offers a complete line of SMPM connectors. The SMPM connector was developed to improve on the application density and operating frequency range of the SMP connector. The SMPM connector is widely used in high density, high performance applications today.

Electrical Specifications

Impedance	50Ω
Frequency	65 GHz
VSWR	1.10:1 to 26.5 GHz typ.; 1.30:1 to 50 GHz typ.
Insertion Loss	.07 v f
Shielding Effectiveness	≥ -80 dB typ.
Dielectric Withstanding Voltage	325 VRMS

Mechanical Specifications

	SB	FD
Mating Cycles	500	100
Force to Engage/Disengage	2.5 / 1.5 lbs	4.5 / 6.5 lbs
Axial Misalignment	.010"	
Radial Misalignment	± .010"	

Environmental Specifications

Temperature Rating	-65°C to +165°C
Corrosion (Salt Spray)	MIL-STD-202, Method 101, Condition B
Vibration	MIL-STD-202, Method 204, Condition D, 20 Gs
Shock	MIL-STD-202, Method 213, Condition I, 100 Gs
Thermal Shock	MIL-STD-202, Method 107. Cond. B, -65°C to +165°C
Barometric Pressure (Altitude)	MIL-STD-202, Method 105, Condition C, 70k Ft.



SMPM

SV Microwave offers a complete line of SMPS connectors. The SMPS connector utilizes the same great features of the SMP and SMPM connector series in an even smaller package. The SMPS series is ideal in applications where density is of the utmost importance.

Electrical Specifications

Impedance	50Ω
Frequency	100 GHz
VSWR	1.10:1 to 26.5 GHz typ.; 1.25:1 to 65 GHz typ.
Insertion Loss	.07 v f
Shielding Effectiveness	≥ -80 dB typ.
Dielectric Withstanding Voltage	250 VRMS

Mechanical Specifications

	SB	FD
Mating Cycles	500	100
Force to Engage/Disengage	2.5 / 1.5 lbs	4.5 / 6.5 lbs
Axial Misalignment		.010"
Radial Misalignment		± .010"

Environmental Specifications

Temperature Rating	-65°C to +165°C
Corrosion (Salt Spray)	MIL-STD-202, Method 101, Condition B
Vibration	MIL-STD-202, Method 204, Condition D, 20 Gs
Shock	MIL-STD-202, Method 213, Condition I, 100 Gs
Thermal Shock	MIL-STD-202, Method 107. Cond. B, -65°C to +165°C
Barometric Pressure (Altitude)	MIL-STD-202, Method 105, Condition C, 70k Ft.



TNC

Developed in the late 1950's, the TNC stands for Threaded Neill Concelman and is named after Amphenol engineer Carl Concelman. Designed as a threaded version of the BNC, the TNC series features screw threads for mating. TNC are miniature, threaded weatherproof units with a constant impedance of 50 Ohms and operate at DC to 11 GHz. As a ruggedized version of the BNC, the TNC features a threaded coupling that offers extra mating stability. TNC connectors are used in many applications including Mil-Aero, instrumentation, and cable assemblies.

Electrical Specifications

Frequency	11 GHz	18 GHz
VSWR	1.3:1 at 11 GHz	1.2:1 at 18 GHz
Impedance		50Ω
Insertion Loss		.06 v f
Shielding Effectiveness		≥ -90 dB
Dielectric Withstanding Voltage		1500 VRMS

Mechanical Specifications

Mating Cycles	500
Mating Torque	12 - 15 in - lb

Environmental Specifications

Temperature Rating	-65°C to +165°C
Corrosion (Salt Spray)	MIL-STD-202, Method 101, Condition B
Vibration	MIL-STD-202, Method 204, Condition D
Shock	MIL-STD-202, Method 213, Condition I
Thermal Shock	MIL-STD-202, Method 107
Moisture Resistance	MIL-STD-202, Method 106, Less Step 7B



Type N

Named after Paul Neill of Bell Labs after being developed in the 1940's, the Type N offered the first true microwave performance. The Type N connector was developed to satisfy the need for a durable, weatherproof, medium-size RF connector with consistent performance through 11 GHz.

Electrical Specifications

Frequency	12.4 GHz	18.0 GHz
Impedance		50Ω
VSWR		1.3:1
Insertion Loss		.07 √ f
Shielding Effectiveness		≥ -90 dB
Dielectric Withstanding Voltage		3000 VRMS

Mechanical Specifications

Mating Cycles		500
Mating Torque		12 - 15 in - lbs

Environmental Specifications

Temperature Rating		-65°C to +165°C
Corrosion (Salt Spray)	MIL-STD-202, Method 101, Condition B	
Vibration	MIL-STD-202, Method 204, Condition D	
Shock	MIL-STD-202, Method 213, Condition I	
Thermal Shock	MIL-STD-202, Method 107	
Moisture Resistance	MIL-STD-202, Method 106, Less Step 7B	

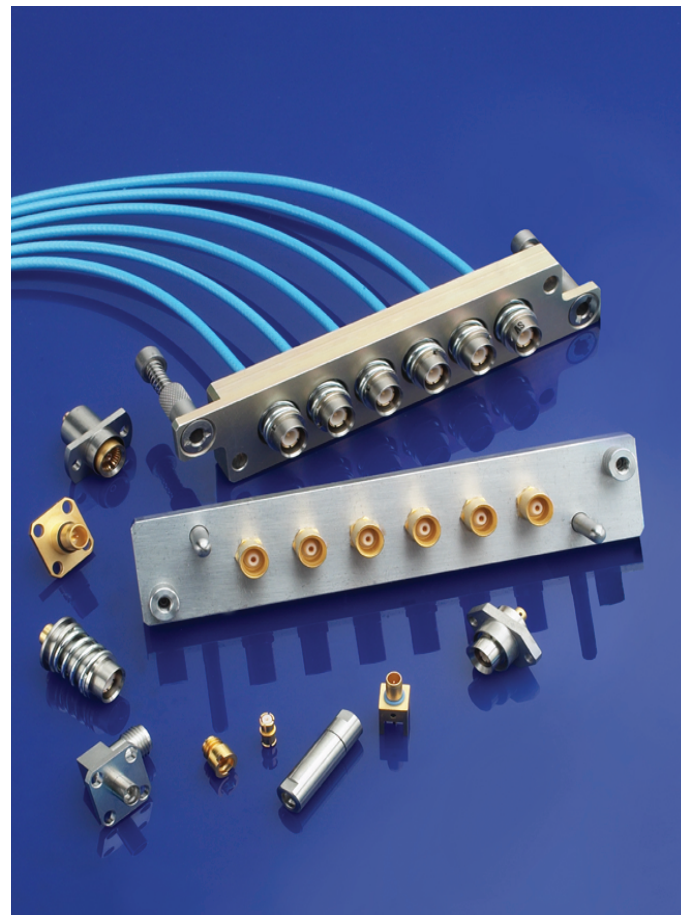

Small in Size, High in Definition



Meet the highest standard for video application (3G-SDI)

- Interface in accordance with M39029 /59 /60





VITA 67

High Density & High Performance RF
Addition to the **OpenVPX** Platform

FEATURES

The foundational coaxial interconnect for RF on VPX platforms

- Standardized microwave interconnect for convenience
- Cable assembly daughtercard modules that mate to backplane adapters
- Floating SMPM coaxial contacts ensure excellent RF performance in any mating condition



VITA 67.1 (3U) and VITA 67.2 (6U)

APPLICATIONS

- High-reliability, high-density for aerospace & defense applications
- SIGINT, EWR, ground base station & communication systems, avionics, radar systems
- Air Transport Racks (ATRs) without Rear Transition Modules (RTMs) or limited speed through RTM
- Available in 3U (4 position) and 6U (8 position) formats
- Designed for side-by-side implementation with VITA 46 hardware

BENEFITS

- Robust and rugged high speed cabled solution
- MIL-STD 810 for shock and vibration
- Minimal footprint of I/O slot
- Rear panel interface enables quick disconnect & replacement of card, leading to a significant reduction in Mean-Time-To-Repair (MTTR) when compared to front panel interfaces
- Utilizes existing and proven SMPM interfaces
- Unique SV connector retention mechanism offers significant ease of assembly/disassembly into daughtercard module over competitor designs



Motherboard Module

SMPM Male to Male Adapter
SMPM male on backside of board

SMPM Female Cable Connector
Configurable to any $\varnothing.086''$ or smaller cable type



Daughtercard Module

Unmanned Aerial Vehicle

Amphenol RF offers the largest selection of RF interconnect products to complete your Unmanned Aerial Vehicle development. We offer QPL and ITAR products, IP67 sealed solutions for harsh environments, and low cost commercial solutions for non-rugged use.

Amphenol RF currently participates on many of the largest UAV programs in the world, giving us years of experience. Whether the aircraft is being used for surveillance, communications, agriculture, or just for hobby use, we have the engineering expertise to support your build.

Applications:

Flight Control modules
 GPS/Networking modules
 Remote Control modules
 Military: Direct Action,
 Surveillance, Comms
 Commercial: Agriculture,
 Delivery, Photography

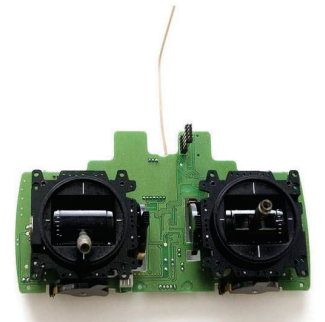

Connectors

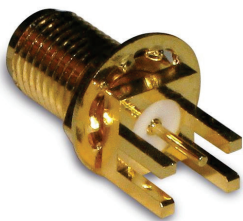

PCB SMA



Flange mount TNC

Adapters



BNC to SMA bulkhead adapter



SMA to RP SMA adapter

Custom Designs

Hybrid cables/connectors
 Full staff of engineers
 Harnessing
 Gangmate
 Adapters



MCX to R/A MCX hand conformable cable

Cable Assemblies



BNC to BNC cable



AMC to bulkhead SMA cable

RF components perform vital functions in mission-critical military electronic systems. Such products require superior performance and reliability in hostile environments and stressful conditions. We offer solutions to defense applications such as ruggedized communications, flight management systems, missiles and radar.

Amphenol RF is recognized as a leading supplier in the military industry for its quality MIL-C-39012 interconnects and innovative product solutions. With decades of expertise in harsh environment interconnects for land, sea, and space, we are a natural partner to support a broad range of ruggedized, high-performance connector and cable assembly requirements. Our forward looking designs and industry leading manufacturing excellence ensures consistent dependability in any battlefield.

Standard RF Connectors

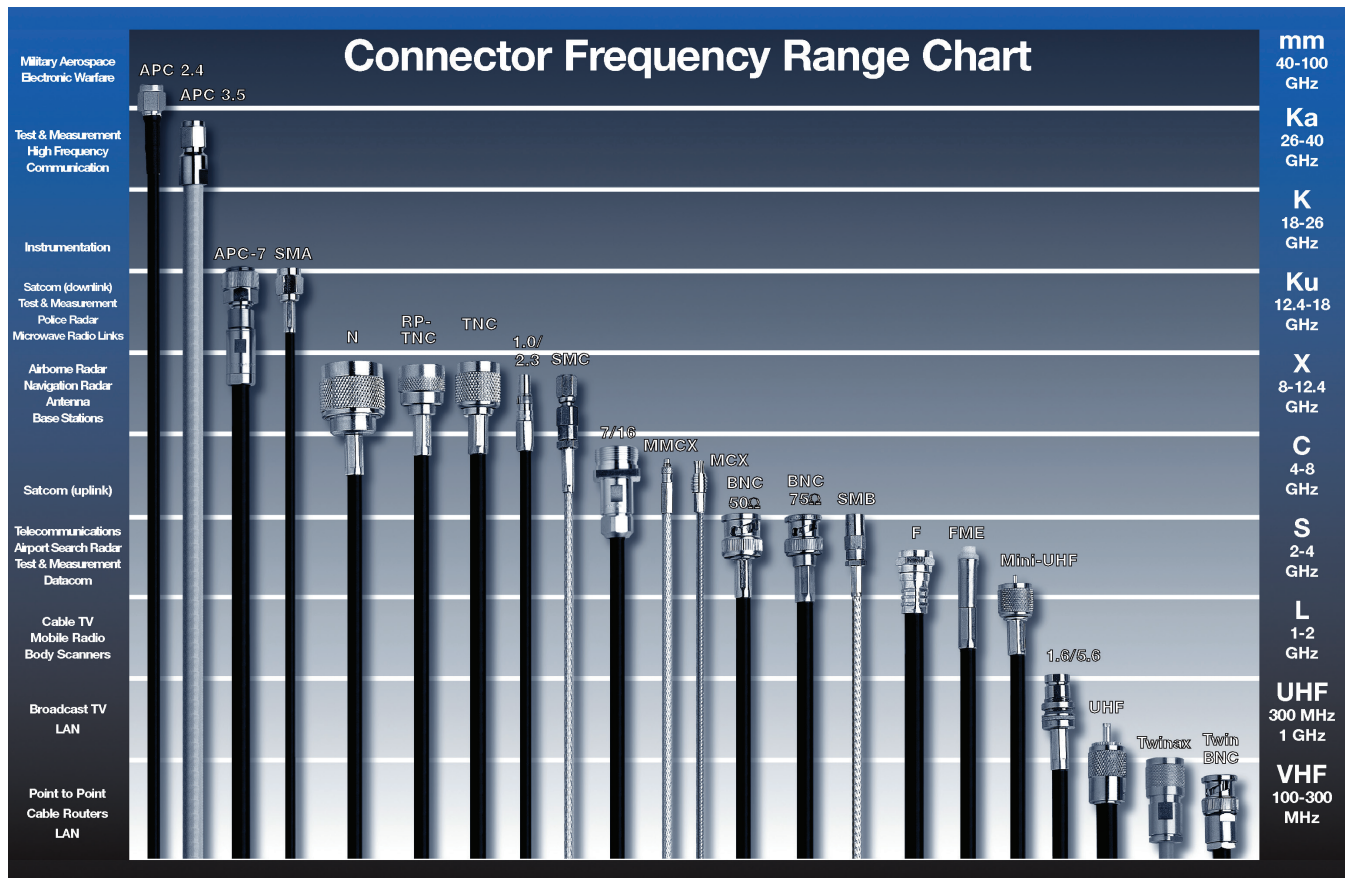

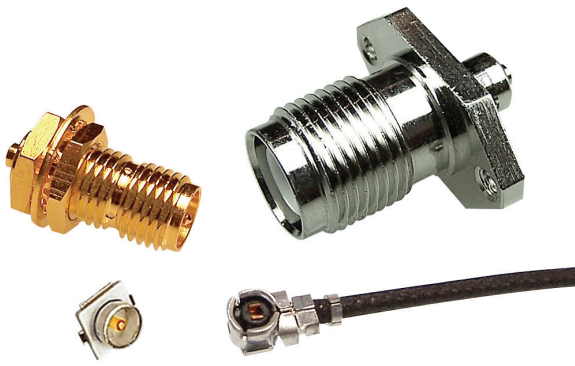

AMC

Description

Amphenol RF manufactures a family of Amphenol Micro Coaxial (AMC) connectors and cable assemblies for use in applications with 50 Ω impedance requirements. AMC connectors are low profile (2.5 mm off the board) and offer an extremely small board footprint (3mm x 3mm).

Features/Benefits

- Easy snap-on/off mating
- Ultra low-profile (2.5mm mating height)
- Small foot print (3mm x 3mm)
- 100% Compatible with Hirose U.FI series
- Right angle plugs are pre-installed on 1.13mm, 1.32 mm or 1.37 mm coaxial cable and tested prior to shipment.

Applications

- Wireless Internet (WiFi, WiMax, EvDO/EvDV Solutions)
- Wireless Infrastructure (Cellular Base Stations)
- RFID
- Bluetooth
- Inventory/Barcode Scanners
- Handheld Devices



SMP

Description

Amphenol RF offers a solution for high frequency, high data rate applications in the SMP line of RF connectors. SMP connectors provide microwave performance and offer a push-on, high performing microwave interconnect system. The available detent systems, full and limited, provide respective levels of engagement/ disengagement forces. This family of interconnects addresses all package design needs. Outside of microwave performance it can be utilized as a highly shielded interconnect for high data rate applications or in a board-to-board blind mate application using a floating bullet. This floating bullet provides a link between mated pairs compensating for both radial and axial misalignment. Available in a cable-to-board mated pair, the plug side can be provided in either right angle or straight with termination capability to either 0.047", 0.086", semi-rigid or conformable coax. The receptacles are designed for surface-mount termination (SMT) or through hole, end launch for board edge or vertical mount. Other configurations are available. Consult factory for price and lead time.

Features/Benefits

- Smaller Package Size
- Higher Frequency Range
- Compensate for Radial and Axial Misalignment

Applications

- Military/Aerospace
- Board-to-Board Interconnect
- Blind Mate
- Broadband
- Instrumentation
- Optical Nodes
- Phased Array Antennas
- Routers
- Telecom



MMCX

Description

MMCX (also called MicroMate™), is a micro-miniature connector series with a snap-lock mechanism allowing for 360 degrees rotation enabling flexibility in PCB layouts. MMCX connectors conform to the European CECC 22000 specification. The MicroMate Family of products is a 6 GHz 50 Ω interconnect system. A range of connectors is available including surface mount, edge card, and cable connectors.

Features/Benefits

- Broadband performance with low reflection DC to 6 GHz
- Quick connect/disconnect snap-on mating reduces installation time
- Conforms to European CECC 22000 specifications
- Available in straight and right angle plugs and printed circuit board connectors

Applications

- Antennas
- Cable Assemblies
- Instrumentation
- Satcom
- Base Stations
- Components
- PCMCIA Cards
- Telecom
- Broadband Communications
- GPS
- Radio Boards



1.0 / 2.3 Connector

Description

The compact European design of the 1.0/2.3 series permits dense connector packing; they are ideally suited to applications where space limitation is a factor. Versions are available with threaded coupling mechanisms which provide positive mating or a unique push-pull coupling system which allows quick installation. The Amphenol push-pull process is patented and ensures positive locking. Amphenol 1.0/2.3 coaxial connectors are 50 Ω units operating from DC-10 GHz. This series complies with DIN 41626, DIN 47297, and NFC 93-571 international specifications.

Features/Benefits

- Push-pull coupling with patented locking mechanism allows quick installation.
- Push-pull offers safe coupling.
- Locking mechanism will not vibrate loose as threaded connectors are prone to do.
- Push-pull connectors can be more densely packed saving panel space in components that are shrinking in size.

Applications

- Amplifiers
- Base Stations
- Cable Assemblies
- Components
- Filters
- Routers
- Switching Equipment
- Telecom

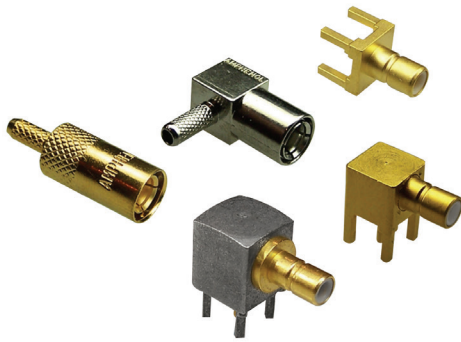
**SMB****Description**

The SMB name derives from SubMiniature B (the second subminiature design). Developed in the 1960's, this sub miniature interface has snap-on coupling. Amphenol's SMB connectors conform to the requirements of MIL-C-39012, and the interface is in compliance with MIL-STD- 348. Available in 50 Ω and 75 Ω , the SMB provides broadband capability through 10 GHz with a snap-on connector design and utilizes die cast components on non-critical areas to provide a low-cost solution.

Features/Benefits

- Broadband performance with low reflection DC to 4 GHz provides low cost connector combined with high quality.
- Quick connect/disconnect snap-on mating reduces installation time.
- Various plating options in nickel, gold, and tin. Selective plating provides corrosion resistance finish as well as good solderability characteristics.
- SMB PCB slide-on plug and jack allows board-to-board mounting with a low insertion force. This is ideal for mating a high number of connectors on a pair of PCB's.

Applications

- Automotive
- Base Stations
- Cable Assemblies
- Components
- Instrumentation
- PC/LAN
- Process Controls
- Radio Boards
- Surge Protection
- Telecom
- Test and Measurement
- Video Systems

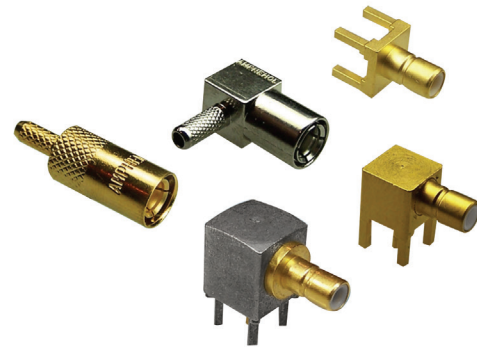
**Mini 75 Ω SMB****Description**

Amphenol's Mini 75 Ω SMB connector provides broadband capability through 2 GHz. Its designs utilize die cast components on non-critical areas to provide a low cost solution. These connectors offer snap-fit mating for quick connect/disconnect. The reduced housing allows circuit miniaturization and efficient "real estate" utilization. Built in accordance with requirements of MIL-C-39012, the interface is in compliance with MIL-STD 348 and is interchangeable with Industry Standard for Miniature 75 Ω SMB.

Features/Benefits

- 75 Ω snap-on coupling allows for quick installation.
- Same interface as 50 Ω SMB.
- Product is interchangeable with competitors.
- Diecast components which offers low cost solution.

Applications

- Telecommunication
- Networking
- Switching Equipment



SMC

Description

The SMC name derives from SubMiniature C (the third subminiature design). The SMC design was developed in the 1960's. SMC has threaded coupling with 10-32 threads. Available in 50 Ω impedance, the SMC Series utilizes die cast components on noncritical areas to provide a low cost solution.

Features/Benefits

- Broadband performance with low reflection DC to 10 GHz.
- Conforms to the interface dimensions of MIL-STD-348.
- 10-32 screw-on (threaded) coupling mechanism allows performance to 10 GHz with low reflection.
- Right Angle connectors available in one piece construction.

Applications

- Antennas
- Automotive (GPS)
- Base Stations
- Cable Assemblies
- Instrumentation
- Video Systems
- Process Controls
- Radio Boards
- Telecom
- Test and Measurement

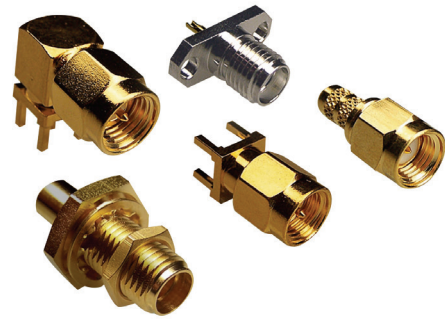

SMA

Description

SMA is an acronym for SubMiniature version A and was developed in the 1960's. It uses a threaded interface. 50 Ω SMA connectors are semi-precision, subminiature units that provide excellent electrical performance from DC to 18 GHz. These high-performance connectors are compact in size and mechanically have outstanding durability. For phase array radar, test equipment, ILS landing systems and other instrumentation using phase matching techniques, these SMA connectors for semi-rigid coaxial cables and the SMA Plug-to-Jack adapter offer a precise and simple means of phase adjustment for microwave devices. Built in accordance with MIL-C-39012 and CECC 22110/111, SMA connectors can be mated with all connectors that meet these interface specifications, regardless of manufacturer. SMA is available both in Standard and Reverse Polarity. Reverse polarity is a keying system accomplished with a reverse interface, and ensures that reverse polarity interface connectors do not mate with standard interface connectors. Amphenol accomplishes this by inserting female contacts into plugs and male contacts into jacks.

Features/Benefits

- Broadband performance DC to 18 GHz with low reflection stainless steel construction and ¼-36 threaded coupling.
- Brass SMA available in nickel or gold plating which provides approximately 30% cost reduction with 100 mating cycles.
- Available for .085" and .141" diameter semi-rigid cables and all the standard flexible cables including double shielded RG-316.
- Phase Adjustable SMA connectors provide ease of mechanical screw adjustments.

Applications

- Base Stations
- Cable Assemblies
- Instrumentation
- Mil/Aero
- Process Controls
- PC/LAN
- Telecom



QMA

Description

The QMA connector is a quick disconnect version of the SMA connector and shares the same internal construction, which allows the connector to have excellent performance. The electrical performance benefits of the QMA include low loss RF performance up to 18 GHz. Because of the innovative coupling mechanism, a 360-degree butt joint is maintained which results in low RF leakage. Since the RF line is identical to the SMA series, the QMA connectors also offer the same high power handling capability. This gives the series significant advantages over other quick disconnect connectors. Amphenol RF is a member of the Quick Lock Formula® Alliance. For further information on the QLF®, visit www.qlf.info.

Features/Benefits

- Operates at the same electrical performance as SMA up to 18 GHz
- Snap-on interface for quick and easy installation
- Rotatable 360° after connection for flexibility with installation

Applications

- Base Station Equipment
- Amplifiers
- Higher Packaging Density, Size equivalent to SMA, but space saving as there is no need for wrench clearance.



Mini - UHF

Description

Mini-UHF is a miniature version of the UHF connectors that were developed for use in the radio industry. Mini-UHF connectors are designed for use as coaxial interconnection in cell phones, automotive systems, and similar applications where size, weight, and cost factors are critical. Mini-UHF connectors terminate to RG-58, RG-58A, RG-58B, RG-58C, and Belden 9258 cables. Crimp-type cable plugs and jacks are available as well as panel and printed circuit board receptacles.

Features/Benefits

- Miniature 3/8-24 thread size provides excellent RF performance
- The small size and light weight provide excellent electrical characteristics
- Crimp-type cable terminations provide low installation cost
- Diecast bodies and molded insulators ensure low cost
- Teflon insulators provide higher temperature range

Applications

- Antennas
- Cable Assemblies
- Cellular

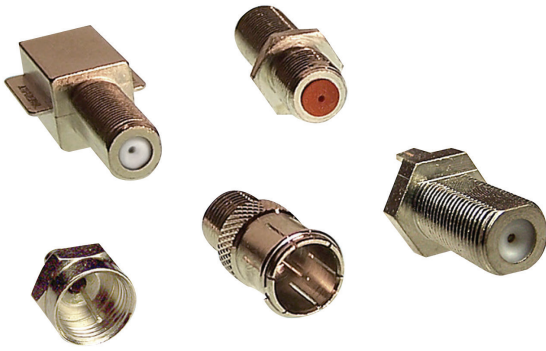

Type F

Description

Type F connectors are miniature threaded connectors used extensively in the cable television industry. The connectors feature a 3/8-32 threaded interface, and cable mounted connectors feature crimp termination. Amphenol’s line of F connectors are designed to meet the demands of high speed cable modems and customer interface units. Primary applications are for cable television (CATV), set top boxes, and cable modems.

Features/Benefits

- Patent pending contact design provides a truly cylindrical coaxial contact and provides superior RF performance and excellent insertion/withdrawal characteristics.
- 30 dB return loss to 1 GHz ensures a high performance specification that outperforms competition.
- Multiple PCB mount packages: surface mount, edge mount, right angle and straight.
- Accommodates .022-.042 inch center conductor sizes.

Applications

- Cable Assemblies
- CATV
- CIMS
- Head End Equipment
- High Speed Cable Modems
- Hybrid Fiber Coax Networks
- Set Top Boxes



Type G

Description

Type G is a slide-on alternative to the Type F with 15A continuous current rating. All connectors comply with the MIL-STD-202 specification for vibration, shock, thermal shock, moisture resistance and salt spray. Since the Type G has an impedance of 75 Ω, it is ideal for CATV applications. This connector line consists of Bulkhead Mount Jack Receptacles and PCB Mount Jack Receptacles.

Features/Benefits

- Push-on blind mate capabilities using BeCu springs provide quick installation and multiple matings
- Version available with 15 Amp continuous current capability meets new generation equipment for HFC Networks (Hybrid Fiber Coax)
- Truly cylindrical coaxial contact provides superior RF performance and excellent insertion/withdrawal characteristics
- 30 dB return loss to 1 GHz with 10 Amp current capability. 20 dB return loss with 15 Amp version provides high performance.

Applications

- CATV
- Head End Equipment
- Components (Amplifiers)
- Hybrid Fiber Coax Networks
- Set Top Boxes



Mini - BNC

Description

Amphenol RF introduces the new generation of quality BNC connectors for the telecommunication and broadband applications for higher connector densities while preserving the positive characteristics of the Amphenol full-size BNC's for 75 Ω systems. This allows 40% more interconnects in the same area. The Mini-BNC series provides the same positive locking bayonet system found on the BNC. These connectors were designed to be field installed or repaired. Also, the Mini- BNC is designed to be a drop-in replacement used in Telco DS3/DS4 applications and is compatible with the present field installer tooling and strip dimensions. DS3 and DS4 lines in Telco Central Offices are 75Ω and the Mini-BNC is as well.

Features/Benefits

- Smaller than the Telco standard BNC allowing 40% more interconnects in the same area
- Crimp/Crimp design compatible with all major manufacturer's tooling
- True 75 Ohm impedance end to end
- Drop-in replacement for most high-density SMB/SMZ applications
- Bayonet coupling provides a positive lock and allows for quick and easy connect/disconnects
- Qualified by most major OEMs
- Made by the Inventors of the BNC

Applications

- | | |
|-------------------------------|------------------------|
| • Broadcast | • Medical Equipment |
| • Custom Cable Assemblies | • Mil/Aero |
| • Digital Video – HDTV | • Satellite Headends |
| • Network Routing & Switching | • DS3/DS4 |
| • Instrumentation | • Telco Central Office |



BNC

Description

Developed in the late 1940's as a miniature version of the Type C connector, BNC stands for Bayonet Neill Concelman and is named after Amphenol engineer Carl Concelman. BNC's are ideally suited for cable termination for miniature to subminiature coaxial cable (RG-58, 59, to RG-179, RG-316, etc.) Amphenol 50 Ω BNC connectors are miniature, lightweight units useable up to 11 GHz and typically yield low reflection through 4 GHz. Amphenol also offers a full line of 75 Ω BNC connectors to meet the needs for higher performance impedance-matched cable interconnections. Part numbers that are listed with the appropriate M39012 number are military grade connectors produced in accordance with and actively qualified to the military specification MIL-C-39012.

Features/Benefits

- Bayonet coupling mechanism provides quick mating and unmating
- 50 Ω and 75 Ω impedance designs allow customers to match system requirements
- 50 Ω and 75 Ω connectors are intermateable
- Four grades of connectors are available for military, industrial, commercial and performance applications

Applications

- | | |
|--------------------|----------------------------|
| • Antennas | • Surge Protection |
| • Base Stations | • Telecom |
| • Broadcast | • Instrumentation |
| • Cable Assemblies | • Oscilloscopes |
| • Computers/LANs | • Medical Equipment |
| • Radios | • Satellite Communications |



TNC

Description

Developed in the late 1950's, the TNC stands for Threaded Neill Concelman and is named after Amphenol engineer Carl Concelman. Designed as a threaded version of the BNC, the TNC series features screw threads for mating. TNC connectors are miniature, threaded weatherproof units with a constant 50 Ω impedance, operating from DC – 11 GHz. There are two types of TNC connectors: Standard and Reverse Polarity. Reverse polarity is a keying system accomplished with a reverse interface, and ensures that reverse polarity interface connectors do not mate with standard interface connectors. Amphenol accomplishes this by inserting female contacts into plugs and male contacts into jacks. Other manufacturers may use reverse threading to accomplish reverse polarity keying. Amphenol's commercial grade connector offering carries the part number designation "RFX" for easy recognition. These low-cost connectors typically utilize die cast and molded components. While performance will not be equal to the industrial or military grade products, these connectors are ideal for use on a variety of commercial applications.

Features/Benefits

- Threaded coupling interface ensures connector will not de-couple in vibration-intensive applications.
- Available in both standard and reverse polarity interfaces.
- Performance from DC – 11 GHz operations in many applications.

Applications

- Antennas
- Cable Assemblies
- Instrumentation
- WLAN Networks
- Telecom
- Base Stations
- Cellular
- Mil-Aero
- Radar
- RFID Readers



C

Description

C Connectors are medium size and weatherproof. Coupling is two-stud bayonet lock. C connectors provide constant 50 Ω impedance. They may be used with 75 Ω cable, at lower frequencies (below 300 MHz) where no serious mismatch is introduced.

Features/Benefits

- Two-stud bayonet lock allows quick & easy coupling

Applications

- Airframe
- Cable Assemblies
- Instrumentation
- MIL Aerospace
- Test & Measurement



UHF

Description

Invented in the 1930's by an Amphenol Engineer named E. Clark Quackenbush, UHF coaxial connectors are general purpose units developed for use in low frequency systems from DC – 300 MHz. Invented for use in the radio industry, UHF is an acronym for Ultra High Frequency. UHF connectors feature a threaded coupling. Because these connectors are low-cost, the impedance is variable. Amphenol's commercial grade connector offering carries the part number designation "RFX" for easy recognition. These low-cost connectors typically utilize die cast and molded components. While performance will not be equal to the industrial or military grade products, these connectors are ideal for use on a variety of commercial applications.

Features/Benefits

- Optional reducing adapters accommodate a wide range of popular coaxial cables
- Solder termination types require no special assembly tools
- Crimp termination types provide a lower cost installation method
- Large-size threaded coupling is rugged design
- Non-demanding specifications and low cost

Applications

- Antennas
- Cable Assembly
- Low Frequency Applications
- Public Address Systems
- CB Radios



Tools

Description

Amphenol offers a full line of termination tooling to meet your specific production requirements. All tools meet Amphenol's stringent design and quality requirements, including full cycle ratchet control, which prevents the connector from being removed from the tool prior to completing the crimping operation. Amphenol's tools provide a consistent and reliable crimp each and every time, thereby ensuring the integrity of the connector termination.

Tool Series

- Bench Mounted Pneumatic Crimp Machine
- CTL Series Crimp Tools
- Hand Crimp Tool
- ECONOHEX Crimp Tool
- MMCX CTL Crimp Tool
- CAP Installation and Connector Removal Tool



RF Feeder Connectors

- One piece pin design
- O ring seals
- Outstanding RF performance
- N and DIN types are available
- Suit for both copper and aluminum cables



RF Panel Mount Connectors

- Different designs for pin termination
- Waterproofing IP68
- Broadband performance covering all wireless service band
- N and DIN types are available

Large Form RF Solutions

PRODUCTS FOR SITE INSTALLATION





Type N

Description

Named after Paul Neill of Bell Labs after being developed in the 1940's, the Type N offered the first true microwave performance. The Type N connector was developed to satisfy the need for a durable, weatherproof, medium-size RF connector with consistent performance through 18 GHz. There are two families of Type N connectors: Standard N (coaxial cable) and Corrugated N (helical and annular cable). Their primary applications are the termination of medium to miniature size coaxial cable, including RG-8, RG-58, RG-141, and RG-225.

Features/Benefits

- Accommodates a wide range of medium to miniature-sized RG coaxial cables in a rugged medium-sized design.
- Broad line of Military (M39012), Industrial (UG) and Commercial (RFX) grade products available.
- Meets many customer application demands with plug styles available in straight and right angle and jack styles available in panel mount, bulkhead mount, and receptacle.

Applications

- Antennas
- Base Stations
- Broadcast
- Instrumentation
- Microwave Radio
- Mil-Aero
- PCS
- Radar
- Radios
- Satellite Communications
- Surge Protection
- WLAN



HN

Description

HN connectors are medium size weatherproof units designed for high voltage applications. HN connectors feature captivated contact design which prevents contact recession under temperature extremes and mechanical stresses. The coupling mechanism features a 3/4 -20 threaded interface.

Features/Benefits

- Rugged construction for high voltage applications
- Captivated contacts prevent movement under temperature extremes
- Nickel plated bodies provide durable surface finish

Applications

- Instrumentation
- Cable Assemblies
- Mil Aerospace
- Airframe
- Test & Measurement



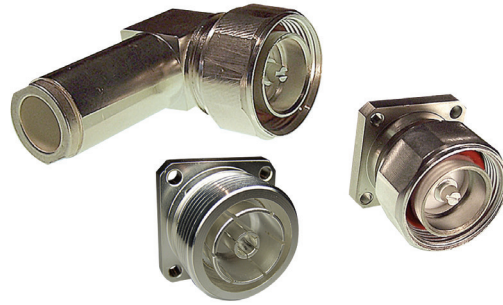

7/16

Description

The 7/16 series name derives from the metric dimensions of the connector interface: 7mm OD of inner contact, 16 mm ID of outer contact. 7/16 connectors are designed for use in communications systems with power levels of 100 watts per channel. Long popular in Europe, the 7/16 interface has gained acceptance in the U.S. for its ability to operate at elevated power levels. There are three families of 7/16 DIN connectors: corrugated cable (both Annular and Superflex), standard cable connectors, and custom. RF coaxial connectors are the most important element in the cable system. Corrugated copper coaxial cables have the potential to deliver all the performance your system requires, but they are often limited by the performance of the connectors. Corrugated connectors have been designed from the ground up to deliver optimum performance, while retaining ease of installation. Inter-modulation distortion, a major concern in today's communications systems, is consistently low with these connectors. Typical performance is -120 dBm (-165 dBc). Amphenol's in-house IMD measurement capability gives us the unique ability to understand the effects of connector design elements on IMD generation so that we can design the best performing connectors in the industry.

Features/Benefits

- Low IMD and VSWR
- Self-flaring design ensures ease of installation
- Pre-assembled gasket protects against dust (P68) and water (IP68) per IEC 169
- Limited internal junctions reduce sources of IMD
- Silver-plated contacts and silver or white
- Bronze-plated bodies deliver a high conductivity and corrosion resistance for a long, trouble-free life
- Easy-Hex coupling nut allows tightening by hand or with a standard wrench for ease of mating

Applications

- Antennas
- Base Stations
- Broadcast
- Jumper Assemblies
- Lightning Protection
- Satellite Communications



RF Adapters

- Low reflection coefficient
- Customer configuration



RF Feeder Jumper Cables

- Excellent VSWR and PIM performance covering all wireless service band
- Complete product range ---- available for any cable type & length with a various connector combination
- Waterproof per IP67 water immersion testing



RF Incabinet Jumpers

- Excellent VSWR and PIM performance
- Using flame retardant cable
- Soldering assembly design
- In BTS cabinet application

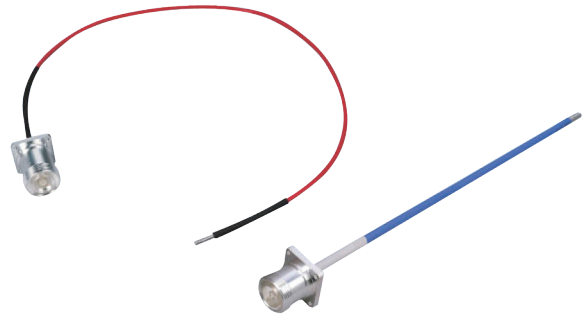

RF Pig Tail Jumpers

- 100% PIM performance testing
- Automatic soldering assembly
- Apply to wireless base station antenna



RF Other Jumpers

- Different design jumpers for different application
- Customized design is available



Earthing Kit

- Broadband

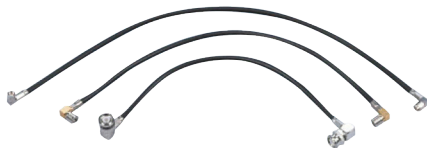
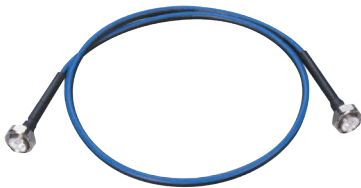

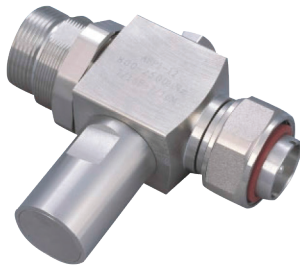

Surge Arrestors

1/4 wave type

- Broadband performance up to 3.9 Ghz
- Fully weatherproof
- Available with type N and DIN connectors
- Provide multiple strike capability

Gas tube type

- DC pass capability
- Field replaceable gas discharge tube

Hybrid type

- Combine the functions of 1/4 wave design and gas tube design

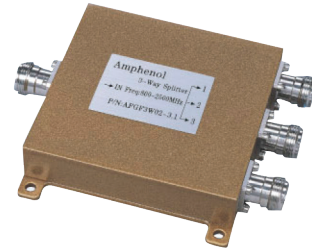

Splitter Coupler

- Broadband characteristics covering all wireless service band
- Outstanding RF performance, high isolation, low insertion loss & low VSWR
- Available with SMA, N and DIN type connectors
- Fully weatherproof to satisfy class IP67 (DIN and N type connector styles)



The Leader in phase stable cables and assemblies
The Leader in low loss cables and assemblies
The Leader in test cables
The Leader in lightning & surge protection

TMS/Amphenol is the leader in the design, qualification, manufacture, and on-time delivery of high performance cable and cable assembly products to the commercial wireless and military marketplace. In 2003, TMS was selected by Lockheed Martin Aeronautics to supply the Broadband Airborne Cable Assemblies on the F-35 Joint Strike Fighter (JSF). TMS was chosen to supply this solution since its high performance cable assemblies are able to handle high-speed data in extreme avionics environments including wide variations in temperature and pressure.

Coaxial Cables

Amphenol



TMS/Amphenol was instrumental in the development of military specifications, including MIL-C-17 for coaxial cables and MIL-T-81490 for Transmission Lines. Times is the leading source of MIL-C-17 qualified products, holding more QPL's (Qualified Product Listings) than any other manufacturer, and Times products meet rigorous MIL-T-81490 and MIL-C-87104 requirements.



Times LMR cables are high performance broadband, flexible, low loss 50 Ohm coaxial communication cables designed for use in wireless applications



TFC/Amphenol is recognized worldwide as one of the pioneer developers of broadband cable technology and has to its credit a long list of technical expertise in foam polymer processing, application-specific product development, and unsurpassed, world-class customer service and support.



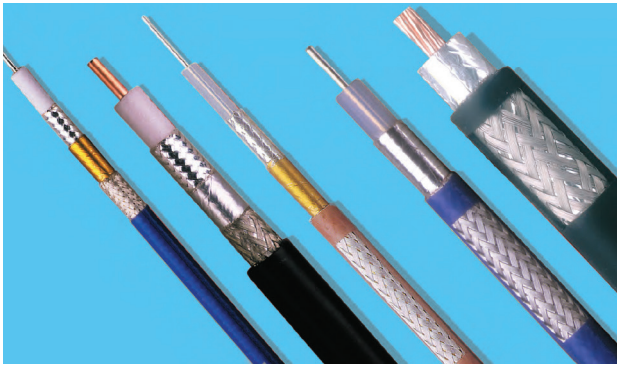

RG Cables

M17/RG

Features & Benefits

- Meets all MIL-C-17 Requirements
- Good Shielding Effectiveness
- Low Passive Intermod (PIM)
- Readily available in Distribution
- Uses Standard Connectors

M17/RG's are traditional MIL Spec coax cables that were born 50-60 years ago. Originally created to support WWII military applications, these cables quickly became the products of choice for commercial wireless applications once they hit the surplus market, and continue to be used today.

M17/RG's have been widely adopted for commercial and military applications. Their QPL stature insures a high quality product made to the same spec regardless of the manufacturer.



LMR

Flexible Low Loss Communications Coax

Ideal for...

- Drop-in Replacement for specific RG cables (uses standard connectors)
- Jumper Assemblies in Wireless Communications Systems
- Short Antenna Feeder runs
- Any application (e.g. WLL, GPS, LMR, WLAN, WISP, WiMax, SCADA, Mobile Antennas) requiring an easily routed, low loss RF cable



Armored Assemblies

Armored versions of many cable types are available as custom cable assemblies. Armored cable assemblies are available in the Miltech, Silverline, and TCOM product lines, as well as others. Available armor types include a range of thick wall flexible jacketing, flexible wire reinforced with extruded thick wall jackets, and full metal coverage crush resistant square-lock styles with various outer jacket types.



LSRG Military Shipboard Coax

MIL-C-17 Qualified

- MIL-Spec Air Frame, Shipboard, Ground (Tactical) Interconnect (M17/180-200)
- Fire Retardant / Low Smoke (non-halogen)
- Flexible For Easy Deployment / Routing

Features & Benefits

- Rugged Abrasion Resistant Jacket
- Excellent Shielding Effectiveness
- Fire Retardant (non-halogen)
- Light Weight
- Flexible for Ease of Deployment
- Excellent Connector Selection

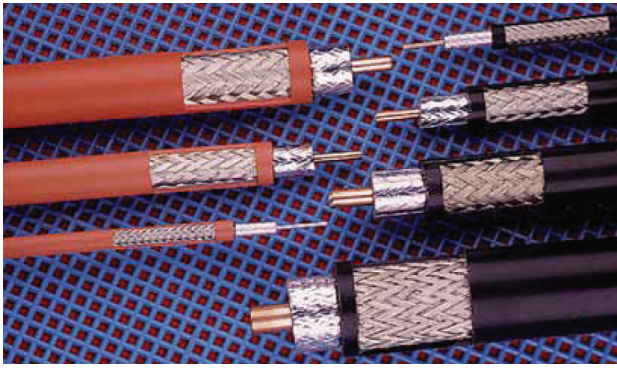

CATV

The low smoke CATV cables are designed to provide a low loss shipboard entertainment system interconnect, yet meet the rigid shipboard requirements per MIL-C-17 "G". Detailed data sheets are available upon request.



TFlex®

Flexible Alternative to Semirigid Coax for Military and Commercial Applications including, Low Loss Microwave and Wireless Base Station Interconnects.

Developed over ten years ago as a lighter weight, flexible alternative to semirigid coax, TFlex® has been widely adopted for both military and commercial communication systems. Its Teflon FEP jacket provides excellent protection in corrosive environments and its flexible nature eliminates the need for hand or precision machine bending. Following the most convenient routing, TFlex® can be preterminated to its desired length and can then be just "plugged in".

Features & Benefits:

- Meets all MIL-C-17 Requirements
- Excellent Shielding Effectiveness
- Low Passive Intermod (PIM)
- Stable Loss, Phase and VSWR vs. Flexing
- Uses Standard Solder-on Semirigid Connectors

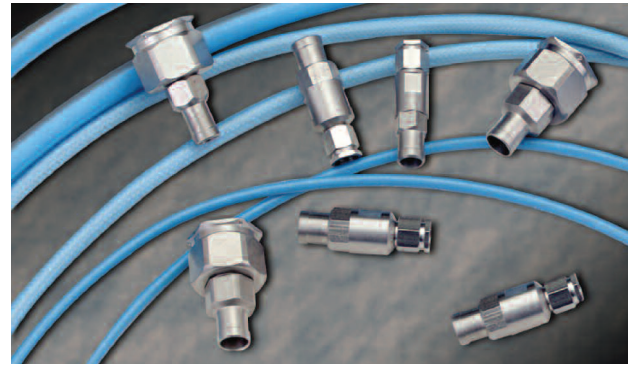

HELIFOIL

Flexible, High Power Interconnect and Jumper Cables for Military/Aerospace and Commercial/Telecom Applications.

HELIFOIL™ ultra low loss, flexible microwave coaxial cable and assemblies provide excellent performance over the DC-18 GHz frequency range. HeliFoil cable comes in three different sizes, with options of stranded center conductors for better flexibility. All sizes provide lowest attenuation, excellent phase stability, broad operating temperature range and high power handling making them a good choice for interconnect and testing applications in both field and laboratory conditions.

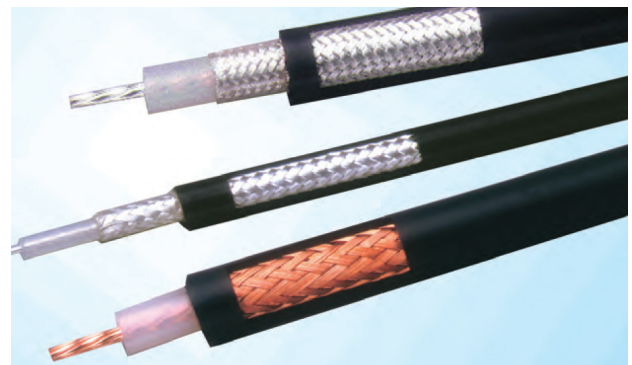

LSSB™

Low Smoke - Non-Halogen Military/Aerospace Coax
MIL-Spec Air Frame, Shipboard, Ground (Tactical)

Features & Benefits

- Rugged Abrasion Resistant Jacket
- Excellent Shielding Effectiveness
- Fire Retardant (non-halogen)
- Light Weight
- Flexible for Ease of Deployment
- Excellent Connector Selection



Hybrid Cell Tower Cables

Power + Optical

Support Next-Generation Wireless
Whether you are installing new or upgrading with wireless remote radio heads (RRHs), you need to reduce installation costs, boost performance to support 4G broadband, and ensure long-term reliability in a scalable solution to future-proof your investment.

Hybrid cables from Times Fiber simplify tower cabling by providing power and optical connectivity in a single cable.

- Flexible Configurations : Get the right mix of power and optical for your tower
- High Performance : Support the latest 4G protocols, such as LTE
- Economical : Lower installation costs by running one cable instead of multiple cables
- Rugged : Tough, sunlight-resistant PVC jacket
- Lightweight : Significantly lighter than designs using corrugated metal shielding, our cables allow easier installation and less tower loading
- Complete : Install faster with factory-terminated assemblies built to your specifications
- Customizable : Specify other configurations of conductor counts, cable types, or shielding— with fast-turn delivery



LLSB

Low Loss Military/Shipboard Coax

MIL-C-17 Qualified

- Low Loss Air Frame, Shipboard,
- Ground (Tactical) Interconnect
- Fire Retardant / Low Smoke (non-halogen)
- Flexible For Easy Deployment / Routing

Features & Benefits

- Lower Loss
- Superior Shielding

Effectiveness

- Fire Retardant (non-halogen)
- Light Weight
- Flexible for Ease of Deployment
- Excellent Connector Selection



Waterblocked, Low-Smoke Triaxial Cables

For applications that require watertightness in addition to the performance requirements of the LS/LT designs, Times is qualified to the M17/134 and M17/135 designs. These triaxial designs meet the 25 psi-6 hour watertightness test, as well as the 1000 psi-2 hour hydrostatic tests that are requirements of MIL-C-17.



Broadband Cables

T10 & TX10 Hardline Cable Solutions

The T10 & TX10 Hardline cable line is constructed with seamless extruded tube. TFC's T10 & TX10 cable will outlast the standard welded tube cables. This cable is designed to eliminate pinhole leaks and micro-cracking. This cable line can be used with industry standard coring tools and connectors.

Features

- Clean coreability and preparation
- Triple bonded
- Tighter bend radius than double bonded cable
- No air gap. eliminates a common path for moisture found in double bonded cable
- Prevents inner conductor pull-out (suckouts) as result of temperature swings.
- Eliminates outer sheath shrink-back due to temperature cycles.
- Works with all industry standard coring tools and connectors
- NEC 820 CATV & CATVR listings available
- Recyclable reels and packaging
- Seamless Extruded Aluminum Tubing



PhaseTrack Cables

Times Microwave TF4 dielectric material is the key ingredient, making our PhaseTrack products the best choice for phase critical interconnect applications.

PhaseTrack cable dielectric has been developed to eliminate the "PTFE knee" in the phase/temperature performance of cables for phase-critical applications.

The PhaseTrack flexible cable product line is available in a range of sizes using TF4 dielectric.



SiO2 Phase Cable Assemblies

SiO2 Semi-Rigid cable assemblies provide formable phase stable performance using materials developed specifically for use in applications where repeatable phase performance is critical. In short, matched TMS SiO2 cable assemblies exhibit the best phase-tracking performance available.

Work with your Times Military/Aerospace Regional Applications Engineer to get the SiO2 Semi-Rigid assembly configurations you need.

The SiO2 product line consists of cables sized from 0.090 to 0.270 inches in diameter.



QEAM

The ultimate cable design for field deployable applications is the QEAM (Quick Erecting Antenna Mast) cable. This cable series is designed specifically for use in demanding, mission critical applications, where reeling and unreeling are required over a wide temperature range. Its performance has been proven on systems such as the Hawk and Patriot Missile. The use of a taped PTFE dielectric results in exceptionally low bending moment and long bend life (typically more than 10,000 bends, depending upon radius, etc.). In the larger sizes, use of a composite center conductor further improves bend properties. Based on our MilTech aerospace cable assemblies, these assemblies are fully weather sealed and constructed in accordance with the requirements of MIL-T-81490. Heavy duty stainless steel connectors provide long term corrosion resistance and ruggedness. Qeam cables are sold only as finished assemblies, tested over the required frequency band and fitted with hoisting grips or otherwise customized to the requirements of the application.



MaxGain

DC-18 GHz Ultra Low Loss Coaxial Cable and Connectors

- Times Unique Spiral Outer Conductor Technology
- Lighter Weight Compared to Competing Technologies

MaxGain™ ultra low loss, flexible Microwave Coaxial Cable and a full range of passivated stainless steel connectors are available as fully tested custom cable assemblies.

MaxGain™ assemblies are used for general applications in both field and laboratory conditions. They are ideally suited for applications where lowest loss and good stability with bending is required.

Features & Benefits:

- Lowest Insertion Loss Available, DC - 18 GHz
- Ultra Stable Insertion Loss and VSWR with Flexing
- With wide Temperature Range (-65°C to + 150°C)
- Extremely Flexible, Low Minimum Bend Radius
- Superior Shielding Effectiveness (> 100 dB)



TCom®-LS

Low Loss Coaxial Cables

For applications that require repeated flexing and the need for excellent electrical performance, the TCOM-LS series offers a non-halogen, low smoke alternative to the more rigid MIL-C-28830 corrugated copper designs.

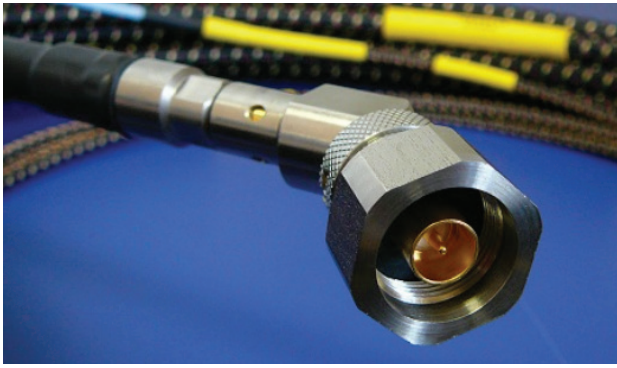

Miltech Cables

This is our high performance workhorse series in the MilTech™ product line. These rugged, low insertion loss, broadband (0.5-18GHz), vapor sealed, cable assemblies with braided Nomex™ outer jackets for abrasion resistance, are qualified to MIL-T-81490 and MIL-C-87104/2 requirements.

Cable sizes from 0.13" dia up to 0.65" diameter provide a wide range of cables - allowing you make the appropriate loss/size/weight trade-off. Replaceable connectors allow field maintenance, and enhanced versatility. Vapor sealed cables provide long life in extreme environments. The MilTech™ cables are "inherently ruggedized," and are engineered using the basic cable design and construction to enhance the handling characteristics of the finished assemblies. Captivated contact terminations provide long-term interface stability. These assemblies were designed from the ground up to provide reliable microwave connections you can count on.

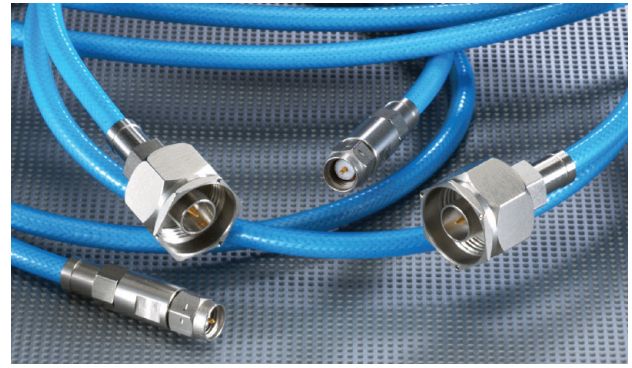

SFT

High Performance Microwave Coaxial Cable, Connectors and Assemblies

SFT™ - Strip Flex Taped

- Low Loss
- Flexible
- Rugged
- High Temperature
- High Power Handling
- Sizes from — SFT-316 (0.120") to SFT-600 (0.565")

SFT™ high performance microwave cables are rugged and flexible, making them ideal for interconnect applications from inside LRU's to system interconnects and antenna feeders in military and commercial systems. The wide range of available connectors covers many interface types and frequency ranges.

Features & Benefits:

- Much lower loss than solid dielectric cables
- Superior shielding effectiveness >100 dB
- Stable Loss, VSWR and phase with flexing
- Available as fully tested, custom cable assemblies

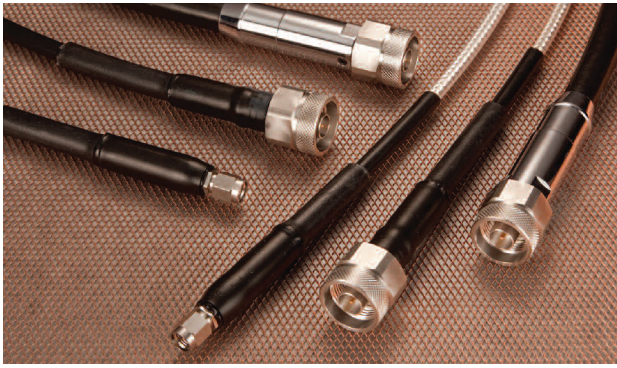

**SilverLine Test Cables**

SilverLine™ Test Cables are cost effective, durable, high-performance cable assemblies designed for use in a broad range of test and interconnect applications. Fabricated from rugged, solid PTFE dielectric cable with stainless steel connectors and a proven strain relief system, these cables provide long life and excellent stability in applications where they are repeatedly flexed and mated/unmated. SilverLine™ test cables are ideal for use in production, field and laboratory test environments. They're also economical enough to be used as interconnects in test systems.

Features and Benefits:

- Phase & Loss Stable
- Long Flex Life
- Triple Shielded Cable
- High Mating Cycle, Stainless Steel Connectors
- Rugged, Solder/Solder Attachment
- Redundant, Long Life Strain Relief System

Silverline Cable Types:

- BronzeLine Test Cables
- SilverLine-LP Low PIM Test Cables
- SilverLine-VNA Network Analyzer Test Cables
- SilverLine-SF Super Flexible Test Cables
- SilverLine-XF Extra Flexible Test Cables
- SilverLine-LL Low Loss Test Cables
- SilverLine-TT Temperature Testing Test Cables
- SilverLine-75 75 Ohm Test Cables
- SilverLine-DAS Low PIM DAS & Component Test Cables
- SilverLine-LPA Low PIM DIN, Mini-DIN and Type N Test Adapters

**T-LNC**

50 and 75 Ohm Low Noise High Performance Cables

- Stable low noise performance
- Reduced mechanically induced electrical noise
- Stranded center conductor for flexibility
- Semi-conductive layering technology
- Ruggedized polyurethane or PVC jacket
- 80° C rated

T-LNC-300-50-PUR

T-LNC-240-75-PVC

Vibration monitoring and wear detection for:

- Aerospace
- Oil & Gas
- Transportation
- Public Utility
- Machinery
- Non-Destructive Testing

Applications:

- Accelerometers
- Strain gages
- Transducers
- Low voltage signaling in high vibration



Antenna Solutions

One Source. Global Site Solutions

50 MHz to 1.5 GHz. Omnis, yagis, panels and stacked dipole arrays for Private Mobile Radio (PMR), Land Mobile Radio (LMR) and Terrestrial Trunked Radio (TETRA).

C & S Antennas offers a broad range of UHF, VHF and SHF antennas.

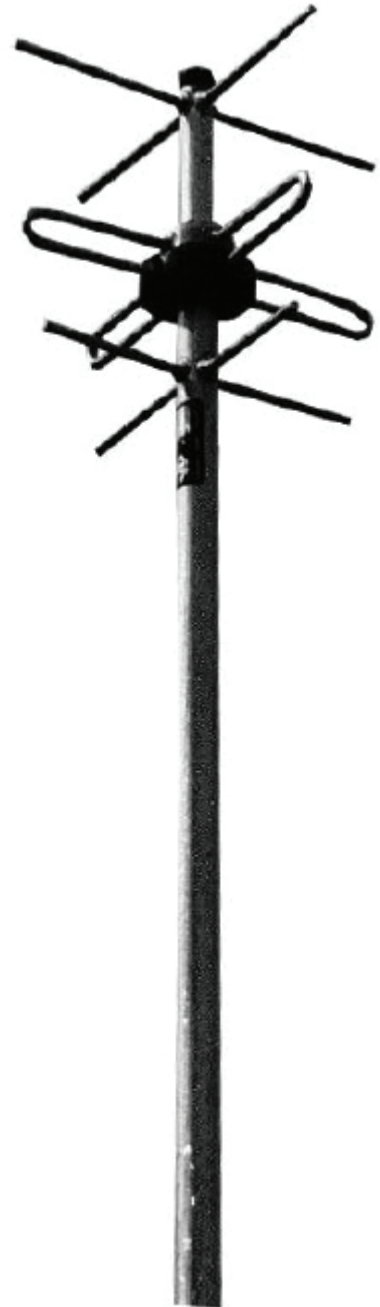



Directional Antennas

A range of Directional Panel Antennas, Stacked Dipole Array Antennas, Sector Antennas and a comprehensive portfolio of multi-element VHF/UHF & SHF yagi directional antennas. Serving markets such as PMR/ LMR /Trunked Radio, Broadcast, Air Radio, GSM-R and TETRA applications. Produced to the highest quality standards, these robust antenna designs will ensure reliable operation in harsh environmental conditions. Low IMP rated models provide a consistently lower noise floor over the life of the antenna whilst some models are covered in a shroud ideal for in tunnel applications.

- Yagi Antennas
- Shrouded Yagi Antennas
- Stacked Dipole Array Antennas
- Directional Panel Antennas
- Sector Antennas
- Miscellaneous Antennas



Omnidirectional Antennas

Amphenol's colinear antennas are designed for deployment in VHF, UHF and SHF networks. A wide variety of options are available including gain, tilt, lightening protection and designs that have low passive intermodulation to minimize network interference.

Antennas are housed inside a high-strength glass fibre shroud and manufactured to the highest quality standard, ensuring long term, reliable operation.

- Colinear Antennas
- Centre-fed Dipole Antennas
- End-fed Dipole Array Antennas
- Ground Plane Antennas
- Miscellaneous Antennas

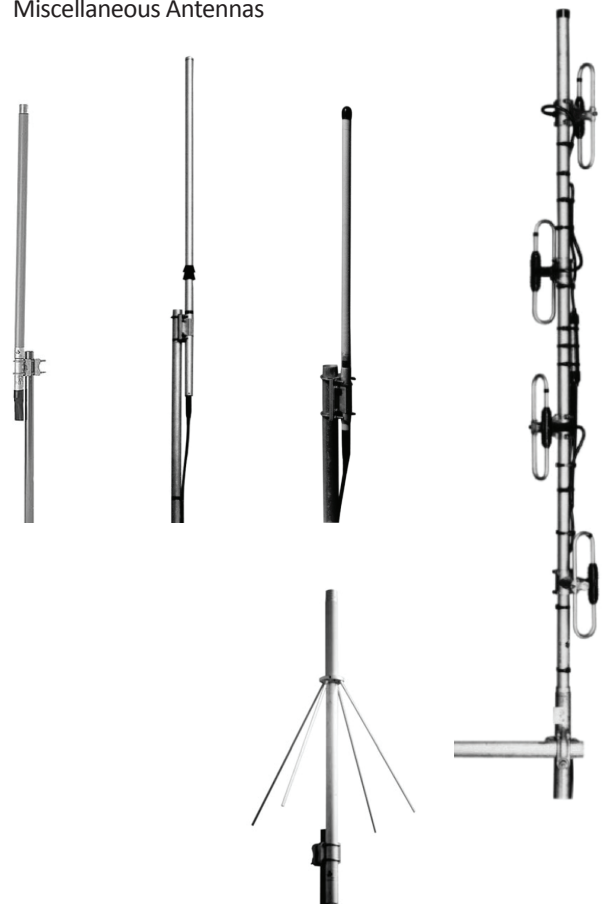



Indoor/Microcell Antennas

Amphenol's DAS, in-building and microcell antennas have been deployed by network operators worldwide to provide improved coverage in office buildings, campuses, tunnels and urban canyons. Our aesthetically pleasing, low profile designs are available in an assortment of directional and omnidirectional configurations giving network engineers the tools needed to optimize coverage in these difficult environments.

Innovative wide band, dual band and tri band configurations are available allowing one distributed antenna system to serve multiple service providers with minimum visual impact.

- Directional Antennas
- Omnidirectional Antennas

Accessories

- Phasing Harnesses
- Mounting Hardware

HF Antenna Systems (1.6-30 MHz)

C&S Antennas manufactures HF wire antennas for short, medium and long range communications. The antennas are designed for tactical, emergency and fast-reaction situations. Wires are Kevlar cored, copper braided and pvc coated with a no-kink feature. They are numbered for accurate set-up and are designed for the military environment with the soldier in mind.



SOF230™ Special Forces Antenna Kit

Special Operations Forces Multi-Configurable Antenna Kit

The SOF230 antenna was designed specifically for the US Special Operations Forces for use in any environment that they may encounter. The SF230 antenna system has fifteen configurations including NVIS, Omnidirectional and Directional that cover short, medium and long range. The kit includes a counterpoise for use when poor ground conditions exist due to dry soil, such as desert conditions. The kit contains a 1:1 and 6:1 BALUN and terminating resistors that allow a broadband antenna to be erected if a tuner or coupler is not used or damaged in the field. All components are built to meet MIL-STD 810G and are extremely durable and long lasting.



MULTILITE™ Tactical Antenna (MTA)

Multi-Configuration Hf Tactical Antenna Sy

The Multilite™ Tactical Antenna system or MTA is a key element in a communication system since its deployment can be controlled by the operator to suit all operational requirements. It is comprised of seven separate antennas for seven roles:

1. Horizontal dipole – omnidirectional at short or medium-range, broadside at long-range
2. Sloping dipole – omnidirectional for short/medium-range
3. Bent dipole – low frequency ground wave
4. Inverted L – low frequency ground waves
5. Base Feed Vertical – omnidirectional for ground and long-distance skywave
6. Sloping V – directional medium-range
7. Inverted V – inverted V long-range directional

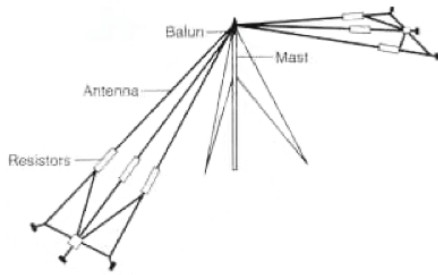

LFH-230 FANLITE™

Omnidirectional Theater Range Hf Wire Ant

The LFH-230 FANLITE™ antenna is a lightweight, transportable HF wire antenna intended for omnidirectional skywave communications to a range of about 2,000 miles, including short-range Near Vertical Incidence Skywave (NVIS) operation. Supplied in a rapidly assembled kit form, the antenna is designed for use with C&S Antennas’ telescopic CARRYMAST™. When erected on one of these masts, the LFH-230 FANLITE™ may be set-up by two people in less than 25 minutes.

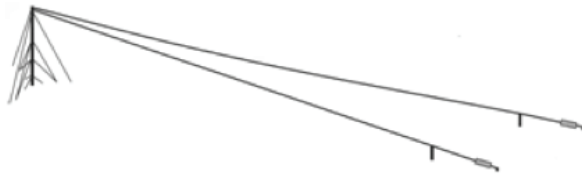

LONGSHOT™

Tactical Long Range Hf Wire Anten

The Longshot™ is a lightweight, transportable HF wire antenna intended primarily for long-range skywave communications. Supplied in a rapidly assembled kit form, the antenna may be erected in a variety of long wire configurations (including a low profile, jam-resistant mode) to meet contingency. The Longshot™ has a 500 Foot Sloping Vee – Long-Range, Transmit/ Receive.



Man-portable Telescopic Masts

CARRYMAST™

CARRYMAST™ is a range of lightweight, man-portable carbon fiber masts available in 9m (30 ft), 10m (34 ft), 12m (38 ft) and 15m (50 ft) standard heights. These lightweight masts are designed to be carried by one person and can be erected in the field in minutes, even under severe weather conditions. CARRYMAST™ was designed to support C&S Antennas’ range of Tactical HF Antennas Systems. An assortment of adapters and accessories are available to support UHF, VHF and microwave antennas as well.

- Rapid deployment, simple operation
- Low weight
- One or two man setup
- Robust and reliable, proven in action
- No pumps or winches necessary
- Compact stowed size
- Low radar cross-section
- Ice resistant
- MIL-STD 810C and NSN listed
- Multi-antenna capable
- Ground, hardstand or vehicle



CARRYMAST™ Accessories

Quoted performance parameters are provided to offer typical or range values only and may vary as a result of normal manufacturing and operational conditions. Extreme operational conditions and/or stress on structural supports is beyond our control. Such conditions may result in damage to this product. Improvements to product may be made without notice.



Integral Tripod

- Used for temporary roof mounting
- Folds along mast body



Tilter / Positioner

- Used to provide boresight stabilization and elevation tilt of narrowbeam antennas



T-Bar Adaptor

- Enable two antennas to be mounted at mast head simultaneously
- Straps to mast body for transportation



Half-Way Up Adaptor

- Side mounting for antenna



Antennas for **TETRA** Networks

Amphenol Antenna Solutions, designs and manufactures antenna technology for TETRA, PMR, Air Radio, Marine, Automobile and Broadcast industries. With over 80-years of experience, Amphenol's comprehensive range consists of 600 products serving system integrators, installer- and network operators.

Our Private Networks division offers a bespoke design service to create an antenna product that exactly matches the electrical and mechanical characteristics required by our customers, or, we can make minor modifications to existing designs, all tested in-house on our outdoor range and indoor anechoic environments.

Amphenol Antenna Solutions operates from eight strategically located manufacturing and R&D centres around the world: USA (2), Mexico, Brazil, France, UK, India and China. With teams of engineers in each regional market working directly with OEMs, operators, system integrators and installers, Amphenol remains at the forefront of relevant antenna design.

Amphenol

Connecting People & Technology

MILITARY & AEROSPACE

Amphenol
Türkiye&MiddleEast

sales@amphenol.com.tr
www.amphenol.com.tr

