



## NENUTEC AIR - ROTARY DAMPER ACTUATOR

STANDARD 2 Nm | 5 Nm | MODULATING CONTROL



### NEAM...02/05 SERIES

NENUTEC standard damper actuators are especially designed and produced for applications in the HVAC systems.

Our wide range of NENUTEC standard damper actuators has been developed to operate and position air dampers of different sizes. Angular positioning of modulating actuators can be controlled by all trade mark controllers.



- Damper size 0.4 m<sup>2</sup> / 1.0 m<sup>2</sup>
- Power supply AC/DC 24V
- Control modulating DC 0(2)...10 V
- Digital greentech technology
- Shaft dimensions  
Ø 6 to 16 mm round / 5 to 12 mm square
- Minimum shaft length 40 mm
- Selectable direction of rotation
- Adjustable angle of rotation
- 1000 mm cable connection
- Customer version (on request)

Pictures might not correspond with technical data.

#### MODEL SELECTION TABLE

Torque	Running time	Power supply	Auxiliary Switch	Model / Type
2 Nm	60...90 sec	AC/DC 24 V ± 15%	No	NEAM24.2-02
5 Nm	70...100 sec	AC/DC 24 V ± 15%	No	NEAM24.2-05



## NENUTEC AIR - ROTARY DAMPER ACTUATOR

STANDARD 2 Nm | 5 Nm | MODULATING CONTROL

### ACTUATOR DIMENSIONS (mm)

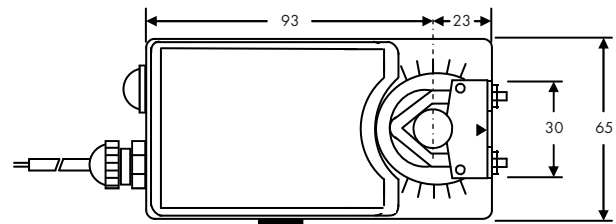
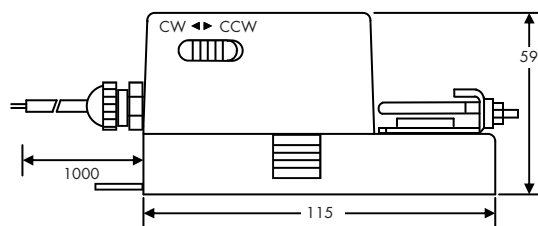

### TECHNICAL SPECIFICATIONS

#### NEAM24.2-...

Torque	2 Nm / 5 Nm
Damper size	0.4 m <sup>2</sup> / 1.0 m <sup>2</sup>
Shaft dimensions	∅ 6 to 16 mm round / 5 to 12 mm square
Power supply	AC/DC 24V ± 15%
Frequency	50 - 60 Hz
Control signal (input)	DC 0(2)...10 V
Position signal (output)	DC 0...10 V
Power consumption	
- Operating	2 W
- End position	1.2 W
For wire sizing	4.0 VA
Auxiliary switch rating	3 (1.5) A, AC 250 V
Protection class	III ⚡
Angle of rotation	0°...90° (95° mechanical)
Angle of limiting	0°...90° (max. 0°...30° / 60°...90°)
Weight	< 0.7 kg
Life cycle	60'000 rotation
Sound level	42 dB (A)
IP protection	IP 54 (dust protected & protected against splash water)
Operating temperature	-20°...+50° C / IEC 721-3-3
Non-operating temperature	-30°...+80° C / IEC 721-3-2
Ambient humidity	5%...95% rH non condensing / EN 60730-1
Maintenance	Maintenance free
Mode of operation	Type I / EN 60730-1
EMC	CE according to 2004 / 108 / EC



## NENUTEC AIR - ROTARY DAMPER ACTUATOR

STANDARD 2 Nm | 5 Nm | MODULATING CONTROL

Wiring diagram NEAM24.2...  
Power supply AC/DC 24 V

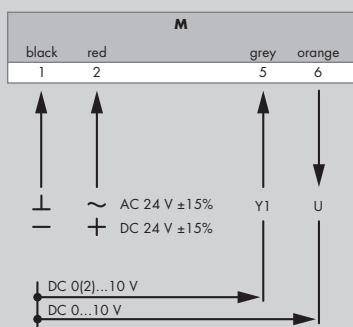

### ■ Changing direction of rotation NEAM24.2-...

Factory-set CW!  
The direction of rotation can be changed by pushing the CW/CCW switch on the actuator's housing.

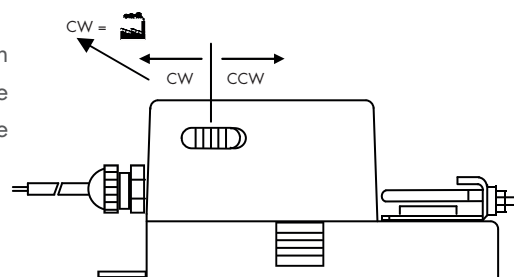

### ■ Adjustment of control signal NEAM24.2...

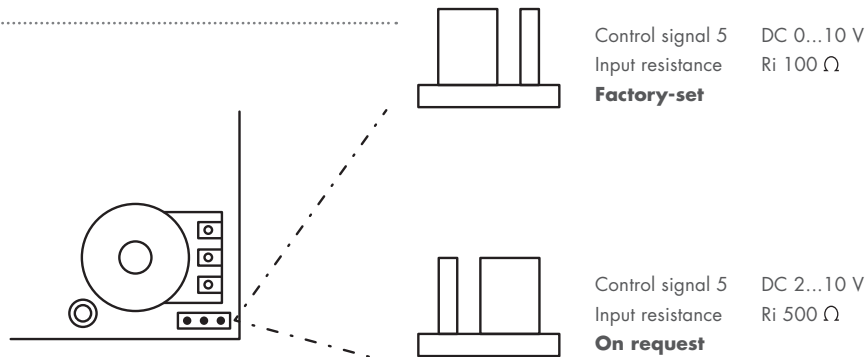

Wiring diagram NEAM24.2...  
Parallel connection

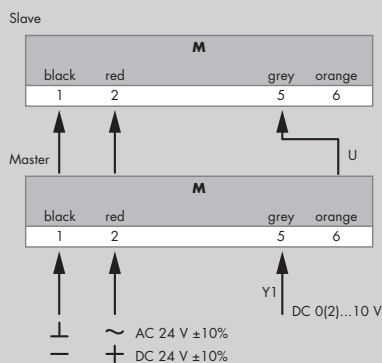

### ■ Remark

When NEAM... actuators operate in parallel (max. 5 actuators), the output signal U = DC 0...10 V (terminal 6) of the master actuator must be connected to terminal 5 of the next slave actuator.

The power consumption and distance between master and slave must be observed.

For more details of installation and commissioning, please observe our mounting instruction manual M-NEAM02-05.



## NENUTEC AIR - ROTARY DAMPER ACTUATOR

STANDARD 2 Nm | 5 Nm | MODULATING CONTROL

### ■ Limiting angle of rotation NEAM24.2...

Adjustment of mechanical limiter

1. Loosen screw of mechanical limiter
2. Move limiter to appropriate position \*
3. Tighten screw

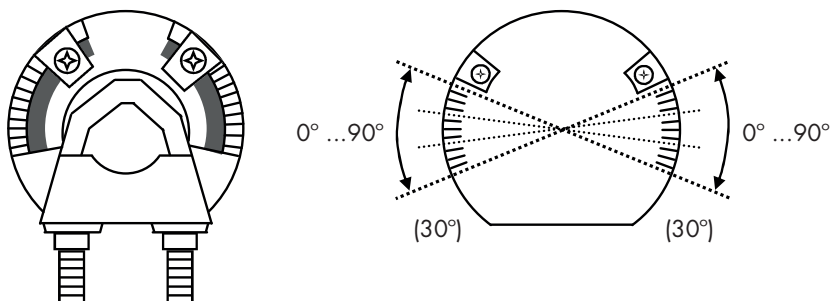

\* Working range of 90° can be reduced up to 30° from each end position.



### IMPORTANT REMARKS

This actuator includes electrical and electronic components and may not be disposed as household garbage. Please consider the local valid legislation.



AC/DC 24 V: Connect via safety isolating transformer. AC 230 V: To isolate from the main power supply, the system must incorporate a device which disconnects the phase conductor (with at least a 3 mm contact gap).

Consult NENUTEC representatives for specific requirements and material selections for your intended application. The entire content of this technical datasheet is protected by copyright with all rights reserved ©.

The performance specifications are nominal and conform to acceptable industry standards. NENUTEC shall not be liable for damages resulting from misapplication or misuse of its products.

### CUSTOMISED VERSION

NENUTEC offers you actuators in customised versions, e.g. with your own brand name, with colour-coordinated applications and with your particular demand on request.

Please contact us for further information.

NENUTEC AG

Schachenstrasse 80  
CH - 8645 Jona/SG - Switzerland  
T: +41 55 224 40 60  
F: +41 55 224 40 69  
www.nenutec.com

Distributor

Distributor