

Industrial Filters and
Hydropneumatic Accumulators





EPE

Particle counters

Type	Pressure	Flow rate
Contamination monitor according to ISO4406:1999 or SAE AS4059.	upto 420 bar	50... 400 ml/min



EPE

Breather filters

Type	Pressure	Connection
TLF-I, TLF-II, TLF-III	–	G 1... G 3



EPE

Desiccant Air Breathers - with Silica Gel

Type	Air Flow Capacity	Connection
DB	16cfm/ 450lpm	1" BSP(M) (others on request)



EPE

Spin on filters

Type	Pressure	Connection
SL, SLS, SLD	7, 25, 50 bar	G 3/4... SAE 1-1/2"

Return line filters

Type	Pressure	Connection
10/16 FRE 10/16 FREN..... DIN 24550 10/16 RL	10/16 bar	G 1/2 . . . DN 300 DN50-DN100



EPE

Duplex return line filters

Type	Pressure	Connection
10/16 FRD 10/16 FRDN..... DIN 24550 10/16 DR	10/16 bar	G 1/2 . . . DN 300 DN50-DN100



EPE

In-line filters

Type	Pressure	Connection
40/160 LE 40/160 LEN..... DIN 24550	40/160 bar	G 1 . . . G 1 1/2
40/100 FLE 40/100 FLEN..... DIN 24550	40/100 bar	DN 50 . . . DN 100
40 FLE 40 FLEN..... DIN 24550	40 bar	SAE 4"
16 FLE 16 FLEN..... DIN 24550	16 bar	DN 125 . . . DN 300
10/16/25/100 L	10~100 bar	DN 50-DN100



EPE

High pressure filters

Type	Pressure	Connection
250/450 LE (inline mounting) 250/450 LEN..... DIN 24550	250/450 bar	G 3/4 . . . SAE 2 1/2"
250/450 FE (manifold mounting) 250/450 FEN..... DIN 24550		DN 14 . . . DN 50

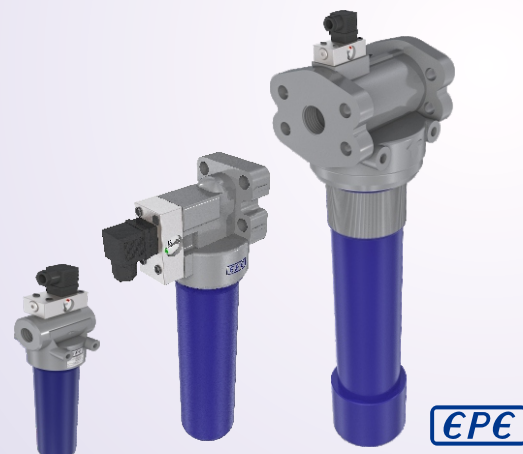

EPE

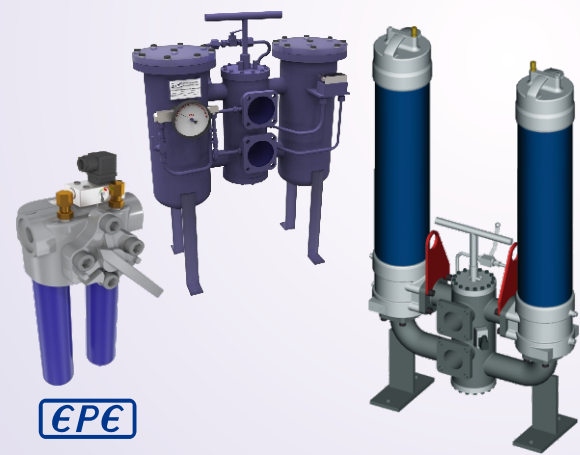

Duplex filters

Type	Pressure	Connection
40/160 LD 40/160 LDN..... DIN 24550	40/160 bar	G 1. . . SAE 1 1/2"
40/160 FLD 40/160 FLDN..... DIN 24550	40/160 bar	DN 50 . . . DN 100
40 FLD 40 FLDN..... DIN 24550	40 bar	DN 100
16 FLD 16 FLDN..... DIN 24550	16 bar	DN 125. . . DN 300
10/16/25/100 D	10~100 bar	DN 50-100



High pressure duplex filters

Type	Pressure	Connection
250/450 LD 250/450 LDN..... DIN 24550	250/450 bar	G 1/2. . . SAE 2"

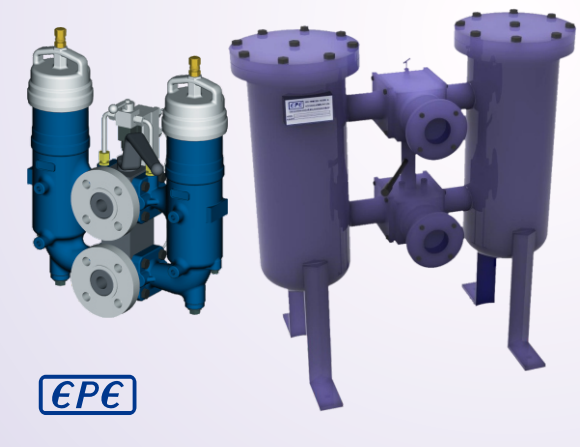

Duplex filters with ball valve

Type	Pressure	Connection
10/16/40 FLDK	10~40 bar	DN 25. . . DN 125...
10/16/25/100 DK	10~100 bar	DN 50. . . DN 125...

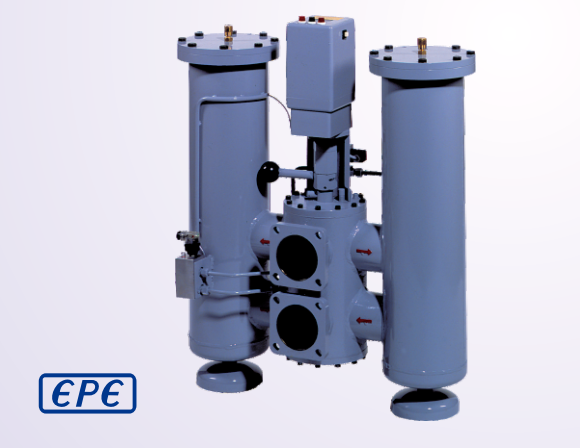

Duplex filters with electric changeover

Type	Pressure	Connection
DE	10 bar	DN 50. . . DN 100

Automatic Back wash filters

Description

Designed for continuous operation for various low-viscosity fluids like water, fuel, coolants etc.

Compact design with low maintenance cost.



EPE

Special design

Description

Custom-built filtration solutions



EPE

Offline filter systems

Type	Nominal flow rate	Pressure
NFF	10 - 170 l/min.	2 - 8 bar

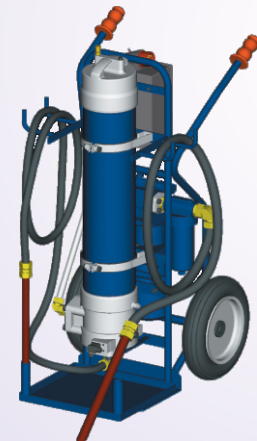

EPE

Filter elements

Type	Pressure	Filter grade
1., 2., 3., 4., 7.	ΔP 15. . . 330 bar	1 μm 2000 μm

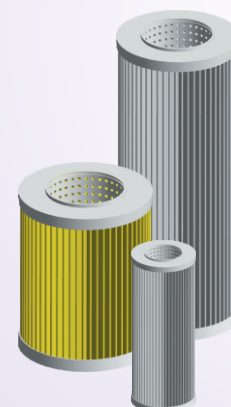

EPE

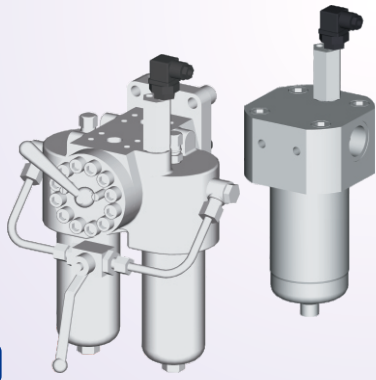

EPE

Process and Industrial filters

Type	Pressure	Connection
EL, ED, G, DG, LW, DLW, DFLW, SFE, BFE	1 . . . 3000 bar	G 1/2 . . . DN 500

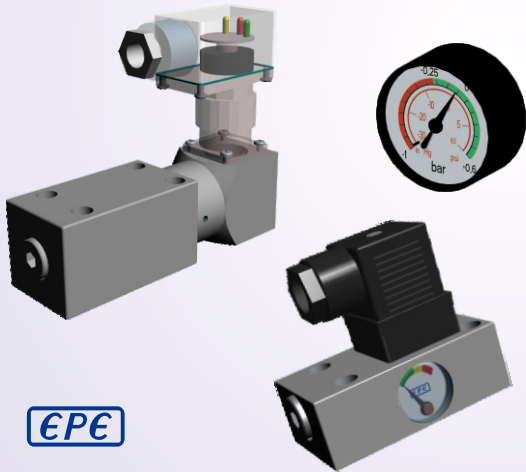

EPE

Maintenance indicators

Type	Pressure	Indicator options
Static pressure - differential pressure indicator	1 - 450 bar	Optical, Optical-Electrical, Electronic



EPE

Skids / Packaged systems

Description

Designed according to customer's specifications relating to varied applications like lubrication, flushing, forwarding, metering etc..



EPE

Accumulator stations

Description

Accumulator systems & stations with single/multiple Accumulators (bladder/piston type), Nitrogen back-up bottles, individual safety blocks, charging blocks, safety relief valves, necessary piping (gas & liquid side)... Duly mounted on common stand.

Application : Energy storage.

Bladder Accumulators

Type	Pressure	Nominal capacity
Bladder accumulators AS, ASHF, ASWD, ASWD	10 - 690 bar	0.2 - 130 Ltrs



EPE

Bladder Accumulators - Large Volume

Type	Pressure	Nominal capacity
Bladder Accumulators ASLV, ASLV-HF	16 - 35 bar	150 - 575 Ltrs



EPE

Diaphragm Accumulators - welded

Type	Pressure	Nominal capacity
Diaphragm accumulators AMW	40 - 350 bar	0.075 - 5 Ltrs



EPE

Piston Accumulators

Type	Pressure	Nominal capacity
Piston accumulators AP (repairable)	220 - 800 bar	0.75 - 1500 Ltrs
Piston accumulators APC (non-repairable)	250 bar	0.08 - 8 Ltrs (Others on request)



EPE



Filters . Accumulators

Other Products of Interest



EPE PROCESS FILTERS & ACCUMULATORS PVT LTD

Techni Towers

C-54/A, A.P.I.E, Balanagar

Hyderabad - 500 037, Telangana, India

Tel. Nos. : +91-40-23778803/23778804/23871445

Fax Nos. : +91-40-23871447

Internet : www.epe-india.com

E-mail : business@epe-india.com

EPE/01.001/CR Rev.5/08-2019