

PRODUCT CATALOG

F-SERIES

Indicators
Totalizers
Transmitters
Flow Computers
Batch Controllers
Monitors
Displays

Flow
Level
Pressure
Temperature

FOR



INTRODUCTION TO THE F-SERIES

The F-Series range offers you an extensive selection of indicators, controllers and monitoring systems for liquid and gas flow applications as well as for level, pressure and temperature measurement.



Industrial applications

The F-Series range has been developed for typical industrial environments. It is sturdy and weather-proof through its aluminum or GRP IP67 / NEMA 4X field enclosure. The enclosure can be mounted directly onto sensors, walls or pipes, but is also suitable for panel mount applications, with one major advantage: it requires minimal depth clearance. The operational temperature specification of the product range is from -40°C to $+80^{\circ}\text{C}$ (-40°F to $+178^{\circ}\text{F}$).

Operational

Fluidwell is acutely aware of the excessive amount of equipment which today's technicians need to control. For this reason, a clear user-friendly menu structure was developed for programming all Fluidwell products a number of years ago: all models are programmed in the same logical manner. The configuration of the unit is completely menu-driven with understandable texts avoiding confusing abbreviations. There are no sensitive DIP-switches or trimmers, you simply select "Flowmeter" as main function, after which you can select "Coil-input" or "Span". The Operator's main information is displayed in clear 17mm (0.7") or 26mm (1") and 8mm (0.3") alphanumeric characters. An adjustable bi-color backlight is available that will switch from green to red in case an alarm is triggered.



Input features

- For flow measurement, the instrument accepts signals from most flowmeters, ranging from PD-meters with reed-switches or hall-effect sensors to turbine sine wave (coil) pick-ups and other NPN/PNP pulse outputs. NAMUR standard sensors and (0)4 - 20mA or 0 - 10V DC analog devices are also catered for.
- For level and pressure measurement, inputs are available for (0)4 - 20mA or 0 - 10V DC signals.
- For temperature measurement, the instrument accepts (0)4 - 20mA or 0 - 10V DC signals, also 2, 3 or 4 wire PT100 elements and thermocouple.

Linearization of the input signal, square root calculation and data filter functions are all available.



Output features

Related to the functionality of the selected product, the following output features are available:

- Analog output proportional to the flow rate, level, differential, ratio, temperature, pressure position or control value. This turns the unit into a powerful transmitter with a local display. The output can also be used to control actuators, valves or pumps.
- Transistor or relay outputs for high and low alarms, pulse output as well as the control of valves / relays in batch control applications.
- The RS232, RS485 or TTL interface makes it possible to communicate remotely, even with the battery-powered unit. All software parameters can be monitored / modified in addition to the usual transfer of data using the Modbus protocol.

Power Management

During the development of the F-Series products, ultra-low power consumption was a key-requirement. Thanks to recent advancements in CMOS technology, Fluidwell has extended the battery life significantly and introduced several smart power-management functions.

Result: a battery lifetime of seven years can be achieved. Additionally, several alternative means of powering the F-Series are available: loop-powered, 24V AC/DC and 115 - 230V AC.

Since all settings are stored in EEPROM memory, you won't lose information when replacing the battery or in the event of sudden power loss. A backup of the running totals is made every minute.

Hazardous area installation

Both Fo- and F1-Series products can be supplied certified Intrinsically Safe to ATEX  II 1 GD EEx ia IIB/IIC T4. For the basic Fo-Series products, certification to IECEx, FM, CSA and non-incendive is expected in the fourth quarter of 2006 with following specifications:

- Intrinsically Safe Class I, II, or III, Division 1, Groups A through G, Ex ia Class I, Zone 0 and 1, Group IIC.
- Non-Incendive Class I, II, or III, Division 2, Groups A through G, Ex nA Class I, Zone 2, Group II.

An explosion-proof enclosure is also available which has been certified in accordance to ATEX  II 2 GD EEx d IIB T5.

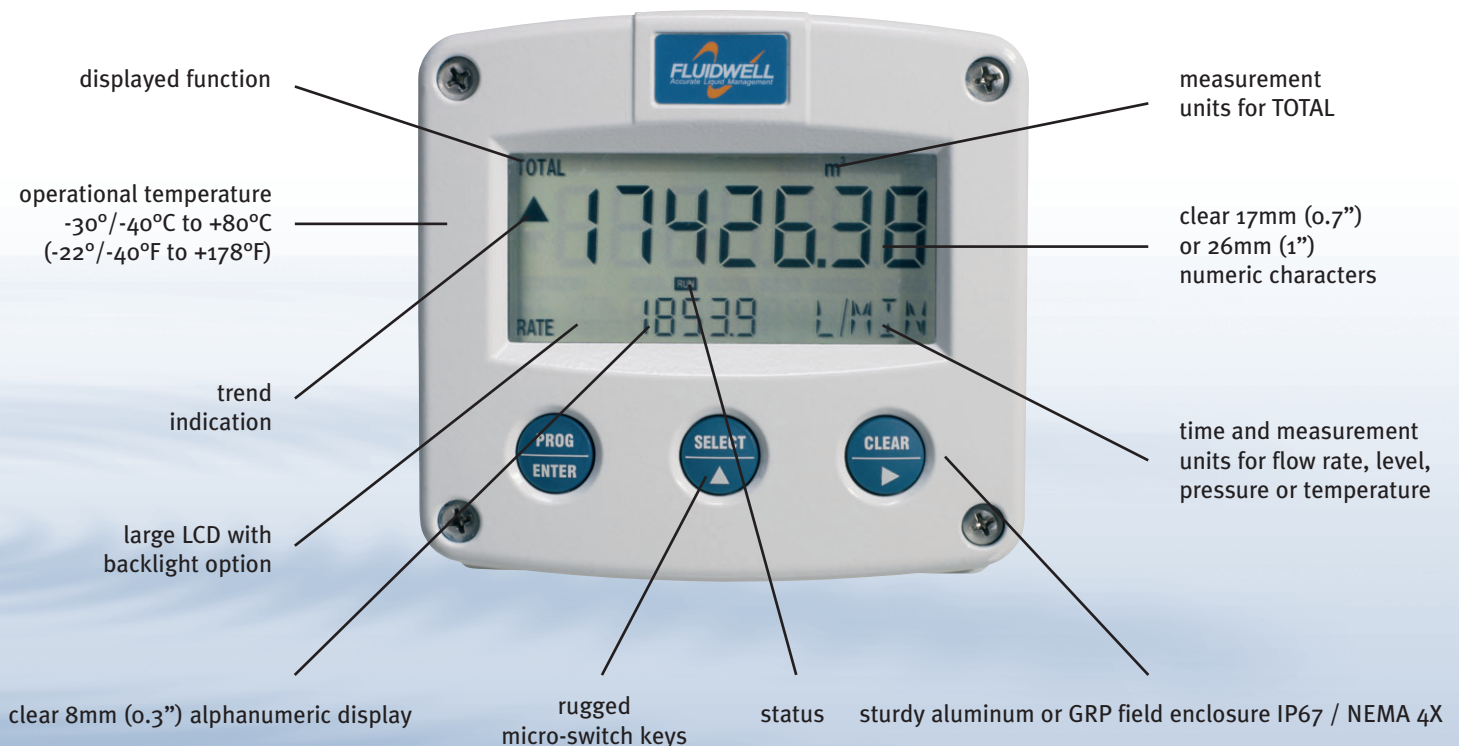

PRESSURE INDICATORS, MONITORS AND TRANSMITTERS



Introduction

This product group offers several solutions from a basic pressure indicator up to a full pressure monitor with signal re-transmitting, high / low pressure monitoring, four alarm outputs as well as full Modbus communication. All being available for both safe area and hazardous area applications. Moreover, wireless data re-transmitting and remote pressure monitoring is offered with our M-series and ProcessMonitor.com products and services.

The functionality of these products is based on two main hardware platforms:

- F0 platform: these products offer one signal input and can have one alarm output. This is our basic product range.
- F1 platform: these products have one or more signal inputs, multiple outputs and communication option. This is our advanced product range.

Both platforms share the same technology, enclosures, display and options but are dedicated to their typical functionality.



Common Pressure Indicator features

- Clear operator information is a key feature of these products. Essential information is displayed as a clear text (e.g. “low pressure”) and not as mysterious abbreviations.
- The dedicated display shows two lines of information at the same time, so the actual pressure is displayed simultaneously with the measuring unit or alarm message.
- The actual pressure is displayed with six 17mm (0.67”) high digits or even with 26mm (1”) high digits (F050).
- The measuring unit is displayed with 8mm (0.31”) digits. The following units can be selected through software: mbar, bar, psi or no unit.

Further product specific features are found on the following pages.



Configuration menu

All configuration settings are accessed via a simple operator menu which can be password protected. Each setting is clearly indicated with an alphanumeric description, therefore avoiding confusing abbreviations and baffling codes. There are no sensitive DIP-switches or trimmers, you simply select “Sensor” as main function, after which you can select “span” or “offset” etc. Once familiar with one F-Series product, you will be able to program all models in the series without a manual. All settings are safely stored in EEPROM memory. The clear and easy structured configuration menu is one of the most appreciated features of the F-Series.

Signal input type

For the pressure indicators, two basic signal input types are available:

- Analog signal: (0)4 - 20mA or 4 - 20mA input loop powered version. The input signal can be tuned within this range (e.g. from 4.0mA to 18.0mA). To avoid signal processing at minimum signal, a low cut-off filter is available.

Product listing

- F050 Pressure Indicator.
- F053 Pressure Monitor with two high / low alarm values and one alarm output.
- F151 Dual Input Pressure Indicator in one enclosure with communication option.
- F153 Pressure Monitor with four high / low alarm values, max. four alarm outputs, analog output and communication option.

- Analog signal: 0 - 10V DC. The input signal can be tuned within this range (e.g. from 2.0 to 5.0V DC). A low cut-off filter is available here too, to avoid counting at minimum signal.

Further, a digital filter can be set to a desired value to stabilize the pressure measurement reading. The offset function allows the indicator to be operational within any desired range (e.g. from 10 bar to 100 bar).

Data protection

All settings are stored in EEPROM memory ensuring that information is not lost in the event of power failure or battery exchange. The configuration menu and alarm values can be password protected to prevent unauthorized access.

For an explanation of all the F-Series options such as analog and alarm outputs, communication, power supply and enclosures, please read the section “Ordering codes” in the back of this catalog.

F050 Pressure Indicator with very large digits

The F050 is a straight forward pressure indicator with large 26mm (1") high digits. The measuring unit to be displayed below the pressure is simply selected through an alphanumeric configuration menu. No adhesive labels have to be put on the outside of the enclosure: a weather proof and user-friendly solution! The configuration of the Span, off-set and number of decimals is done through software functions, without any sensitive DIP-switches or trimmers. A wide range of options further enhance this model capabilities, including Intrinsic Safety for hazardous area applications.

Features

- Displays actual pressure and measuring unit.
- Very large 26mm (1") high digits for pressure.
- Piegraph indication: ten segments.
- Selectable on-screen engineering units: mBar, Bar or PSI.
- Number of digits for pressure: 5¹/₂.
- Green/amber LED backlight with adjustable intensity.
- Auto backup of settings in EEPROM memory.
- Operational temperature -40°C to +80°C (-40°F to 178°F).
- Easy configuration with clear alphanumeric display.
- Very compact design for panel mount, wall mount or field mount applications.
- Rugged aluminum or polyamide field mount enclosure IP67 / NEMA 4X.

Applications

- Applications where a basic pressure measurement display is required without pressure monitoring or signal re-transmitting. More advanced models: F053, F151 and F153.

Pressure input

- Analog: (0)4 - 20mA, 0 - 10V DC.

Analog output

- No.

Alarm output

- No.

Communication

- No.

Power supply

- Loop or battery powered, 8 - 24V AC/DC or 115 - 230V AC. Sensor supply 8.2, 12 or 24V DC.

Hazardous area

- ATEX, IECEx, CSA and FM approvals available for Intrinsically Safe and non-incendive applications.
- ATEX approval available for explosion proof enclosure.

Display example



Application overview

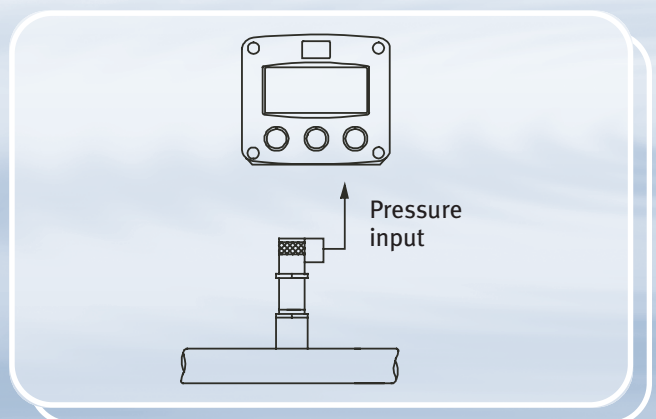

F053 Pressure Monitor with one high / low alarm output

The F053 is a versatile pressure indicator with continuous pressure monitoring feature. It offers the ability to set one low pressure and one high pressure alarm value. If desired, an alarm ignore function can be set up to allow for an incorrect pressure for a certain period of time. The configuration of the Span, off-set and number of decimals is done through software functions, without any sensitive DIP-switches or trimmers. The display shows the actual pressure, alarm values, alarm messages and status. On-screen engineering units are easily configured from a comprehensive selection. A wide range of options further enhance this model capabilities, including Intrinsic Safety.

Features

- Pressure monitoring: two alarm values can be set: low and high pressure alarm.
- Alarm values can be changed by the operator or they can be password protected.
- One alarm output for high, low or both pressure alarms.
- Pressure: six large 17mm (0.67") digits.
- Selectable on-screen engineering units: mBar, Bar, PSI.
- Red flashing LED backlight in case of a pressure alarm; intensity adjustable.
- Displays clear alarm messages.
- Auto backup of settings in EEPROM memory.
- Operational temperature -40°C to +80°C (-40°F to 178°F).
- Very compact design for panel mount, wall mount or field mount applications.

Applications

- For applications where continuous pressure measurement and monitoring is important without signal re-transmitting. Alternative basic model: F050 or more advanced models F151 and F153.

Display example

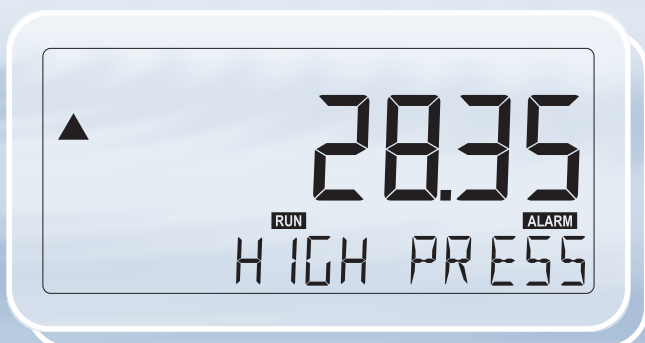

Pressure input

- Analog: (0)4 - 20mA, 0 - 10V DC.

Analog output

- No.

Alarm output

- One configurable alarm output for high, low or both pressure alarms.

Communication

- No.

Power supply

- Loop or battery powered, 8 - 24V AC/DC or 115 - 230V AC. Sensor supply 8.2, 12 or 24V DC.

Hazardous area

- ATEX, IECEx, CSA and FM approvals available for Intrinsically Safe and non-incendive applications.
- ATEX approval available for explosion proof enclosure.

Application overview

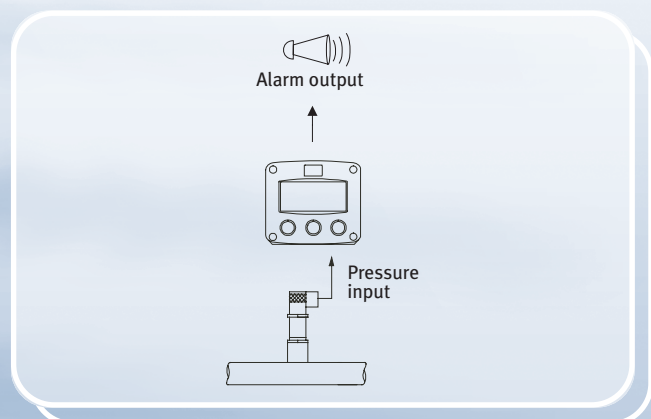

F151 Dual Input Pressure Indicator

The F151 incorporates two pressure indicators in one enclosure. There is no relationship between the inputs, even different measuring units can be used. The measuring unit is displayed together with the input channel information A or B. The F151 can be set to show the selected information manually or with an automatic toggle function. A wide range of options is available to further enhance this model capabilities, including Intrinsic Safety and full Modbus communication.

Features

- Two pressure indicators.
- Displays actual pressure, measuring unit and product I.D. simultaneously.
- Pressure: six 17mm (0.67") digits.
- Separate engineering units for each input.
- Backup of settings in EEPROM memory.
- Operational temperature -30°C to +80°C (-22°F to 178°F).
- Very compact design for panel mount, wall mount or field mount applications.
- Rugged aluminum or polyamide field mount enclosure IP67 / NEMA 4X.
- LED backlight available.

Applications

- For applications where two indicators are required but one single and compact enclosure is desired. Alternative basic model: two separate F050s.

Pressure input

- Analog: (0)4 - 20mA, 0 - 10V DC.

Analog output

- No.

Alarm output

- No.

Communication

- RS232 / RS485 / TTL. Modbus ASCII / RTU protocol. All process data and settings are accessible.

Power supply

- Loop or battery powered, 8 - 24V AC/DC or 115 - 230V AC. Sensor supply 8.2, 12 or 24V DC.

Hazardous area

- ATEX approval available for Intrinsically Safe and explosion proof applications.

Display example

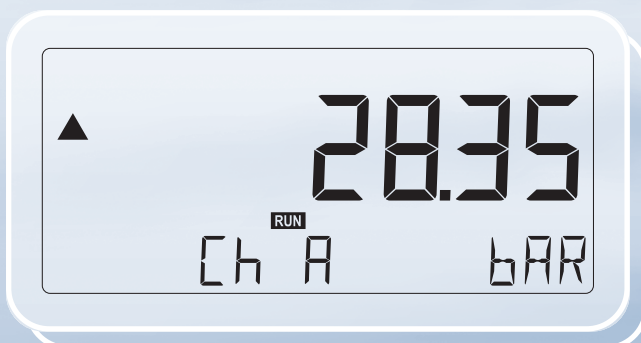

Application overview

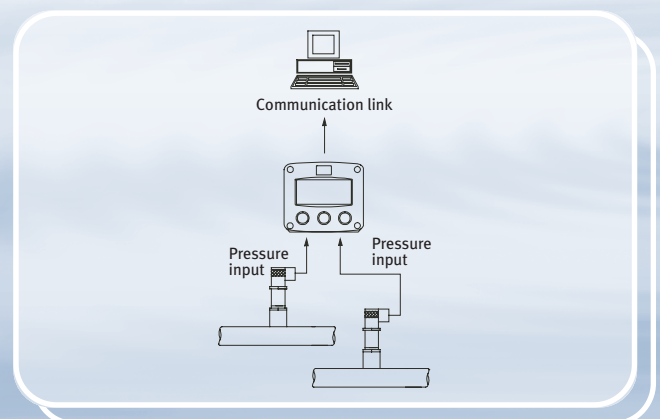

F153 Pressure Monitor with analog and high / low alarm outputs

The F153 is a versatile pressure indicator with continuous pressure monitoring feature. It offers the ability to set two low pressure and two high pressure alarm values. If desired, an alarm ignore function can be set up to allow for an incorrect pressure for a certain period of time. Up to five outputs are available to transmit the alarm condition and actual pressure. The display shows the actual pressure, alarm values, alarm messages and status. On-screen engineering units are easily configured from a comprehensive selection. A wide range of options further enhance this model capabilities, including Intrinsic Safety and full Modbus communication.

Features

- Pressure monitoring: four alarm values can be set: low-low, low, high and high-high pressure alarm.
- Alarm values can be changed by the operator or they can be password protected.
- Analog output to transmit the actual pressure.
- Up to four configurable alarm outputs.
- Displays pressure, measuring unit and alarm messages simultaneously.
- Pressure and alarm values: six large 17mm (0.67") digits.
- Alarm ignore function allows an incorrect pressure for a certain period of time.
- Selectable on-screen engineering units: mBar, Bar and PSI.
- LED backlight available.

Applications

- Pressure measurement where continuous pressure monitoring and re-transmitting is important, or serial communication is required. Alternative basic model: F050 or F053.

Pressure input

- Analog: (0)4 - 20mA, 0 - 10V DC.

Display example

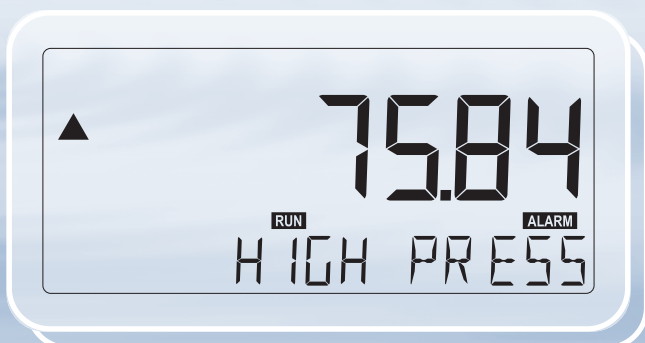

Analog output

- One (0)4 - 20mA / 0 - 10V DC output to transmit the pressure. The signal can be scaled to any range (e.g. from 100 PSI to +1100 PSI).

Alarm output

- Up to four configurable alarm outputs for low-low, low, high, high-high or any combination.

Communication

- RS232 / RS485 / TTL. Modbus ASCII / RTU protocol. All process data and settings are accessible.

Power supply

- Loop or battery powered, 8 - 24V AC/DC or 115 - 230V AC. Sensor supply 8.2, 12 or 24V DC.

Hazardous area

- ATEX approval available for Intrinsically Safe and explosion proof applications.

Application overview

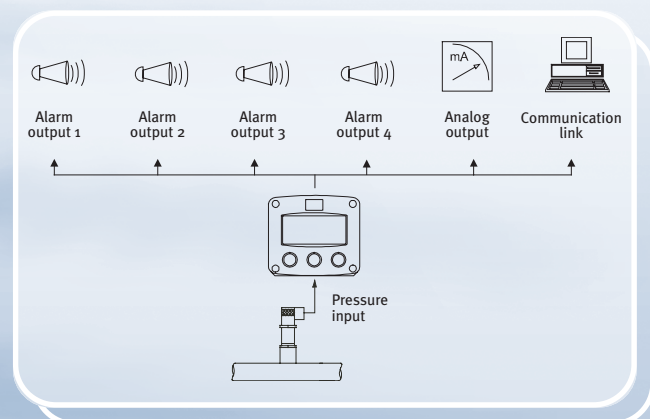

ORDERING CODES







This section describes the options and ordering codes of all F-Series products.



The  symbol indicates if the function is available Intrinsically Safe. The table on the following pages shows which options are available for each product. As it is our policy to improve our products continuously, it is advised to check the datasheets on our website www.fluidwell.com for up-to-date information about the latest options available.

Sensor input signal



This is the primary signal input type of the device. The configuration menu of each product allows you to select and adjust the signal parameters, without any sensitive mechanical DIP-switches, jumpers or trimmers. The analog input version “type A” is also available as 4 - 20mA input loop powered display (power supply type PL).

A		(0)4 - 20mA sensor input for flow, level, pressure and temperature measurement.
H		Thermocouple input for temperature measurement. Available types: check the latest datasheets.
P		Pulse input for flow applications. Signal types: sine wave (coil), NPN, PNP, reed switch, Namur and active signals. For most signals a low pass filter can be enabled.
T		PT100 (PRTD) input for temperature measurement, suitable for 2 or 3 wire (Fo: 4 wire as well).
U		0 - 10V DC sensor input for flow, level, pressure and temperature measurement.
X		No primary signal input (model F193 only).



Analog output signal

Available for the F1-Series only: related to the actual flow, level, height, pressure, temperature, percentage, ratio, consumption, differential or sum, position, energy or as control output. *Note: an active analog output comes with an active transistor output type OA and requires a power supply option type PD, PF or PM.*

AA		Active 4 - 20mA analog output - requires OA + PD, PF or PM.
AB		Active 0 - 20mA analog output - requires OA + PD, PF or PM.
AF		Passive floating 4 - 20mA analog output for Intrinsically Safe applications - requires PC, PD or PL.
AI		Passive isolated 4 - 20mA analog output - requires PB, PD, PF, PL or PM.
AP		Passive 4 - 20mA analog output signal. Output loop powered which means that the unit will be powered through this loop (comes with type PX as standard).
AU		Active analog output 0 - 10V DC - requires OA + PD, PF or PM.
AX		No analog output.



Communication

Available for the F1-Series only: all process data, settings and functions can be read, modified and controlled through the Modbus RTU / ASCII communication link. The selectable communication speed is 1200, 2400, 4800 or 9600 baud and 255 addresses can be assigned. Full Modbus functionality remains available for the Intrinsically Safe version (TTL). *Note: some models do not support Modbus ASCII.*

CB	RS232 - Modbus communication. Maximum cable length 15 meters (50 feet), no multi drop (1:1).
CH	RS485 - 2 wire - Modbus communication. Maximum cable length 1200 meters (3,937 feet), multi drop (1:n).
CI	RS485 - 4 wire (RS422) - Modbus communication. Maximum cable length 1200 meters (3,937 feet), multi drop (1:n).
CT	TTL (RS232 compatible) - Modbus communication, Intrinsically Safe only. No multi drop (1:1). Cable length: the normal RS232 limitations of bandwidth versus cable length are applicable. As a rule of thumb, speed (baud) x length (meters) < 15,000.
CX	No communication option.

Flow equations

The flow computers F126 and F127 use generic formulas for corrected gas and liquid volume.

EG	Formula for gas applications with temperature and pressure compensation.
EL	Formula for liquid applications with temperature compensation.
EX	No flow equations option.





Enclosures

Various types of enclosures are available for hazardous and safe area applications. The enclosures have recently been redesigned with a new keyboard and sealing to make them suitable for even the most harsh environments and to improve the operation. All enclosures have stainless steel screws. The aluminum enclosures are painted with a high quality UV stabilized two component industrial paint. The GRP enclosures (Glass-fiber Reinforced Polyamide) are UV stabilized and offer Vo acc. to UL94. New stainless steel accessories are available for wall and pipe mounting of the field enclosures (see section Accessories).

HA	Field / wall mount enclosure	IP67 / NEMA 4X	Aluminum	Cable entry: 2 x PG9 and 1 x M20.
HB	Panel mount enclosure	IP65 / NEMA 4	Aluminum	
HC	Panel mount enclosure	IP65 / NEMA 4	GRP	
HD	Field / wall mount enclosure	IP67 / NEMA 4X	GRP	Cable entry: no holes.
HE	Field / wall mount enclosure	IP67 / NEMA 4X	GRP	Cable entry: 2 x 16mm and 1 x 20mm.
HF	Field / wall mount enclosure	IP67 / NEMA 4X	GRP	Cable entry: 1 x 22mm (0.866").
HG	Field / wall mount enclosure	IP67 / NEMA 4X	GRP	Cable entry: 2 x 20mm.
HH	Field / wall mount enclosure	IP67 / NEMA 4X	GRP	Cable entry: 6 x 12mm.
HM	Field / wall mount enclosure	IP67 / NEMA 4X	Aluminum	Cable entry: 2 x M16 and 1 x M20.
HN	Field / wall mount enclosure	IP67 / NEMA 4X	Aluminum	Cable entry: 1 x M20.
HO	Field / wall mount enclosure	IP67 / NEMA 4X	Aluminum	Cable entry: 2 x M20.
HP	Field / wall mount enclosure	IP67 / NEMA 4X	Aluminum	Cable entry: 6 x M12.
HT	Field / wall mount enclosure	IP67 / NEMA 4X	Aluminum	Cable entry: 1 x 1/2" NPT.
HU	Field / wall mount enclosure	IP67 / NEMA 4X	Aluminum	Cable entry: 3 x 1/2" NPT.
HZ	Field / wall mount enclosure	IP67 / NEMA 4X	Aluminum	Cable entry: no holes.



Inputs - additional pressure or switch input

Available for the F1-Series only: several products offer or require additional inputs with following functionality:

IA		(0)4 - 20mA input for pressure measurement.
IB		Additional reset input to zero the totalizer.
IU		0 - 10V DC input for pressure measurement.
IX		No additional input.





Outputs - alarm / pulse / control

Following switch output(s) are related to the totalizer (scaled pulse or alarm output), high / low alarms for flow, level, pressure or temperature or control outputs for the batch controllers. The Fo-Series offers maximum one output. The F1-Series maximum of four outputs, however in case of an Intrinsically Safe application a maximum of two outputs are available. Except the passive transistor (type OT), all output types require a power supply option type PD, PF or PM. For detailed information please consult the product datasheet.

OA		Active 24V transistor output(s), requires type PD, PF or PM. (F1-Series also: AA, AB or AU), max load: 50mA @ 24V DC.
OR		Mechanical SPST relays - isolated, requires type PF or PM, max. load 1A - 230V AC.
OS		Four mechanical SPST relays - isolated, requires type PD, max. load 1A - 230V AC.
OT		Passive transistor output(s), max. load 300mA @ 50V DC, (Intrinsically Safe max. 30V DC 100mA) per output.
OX		No output.





Power supply

To power the F-Series, several power supply options are available. For detailed information please consult the datasheet of the product.

PB		Long life lithium battery - only one battery required.
PC		Intrinsically Safe lithium battery - only one battery required.
PD		16 - 24V DC power supply with limited sensor supply capabilities.
PF		24V AC / DC power supply with full sensor supply.
PL		Input loop powered, the unit is powered through the 4 - 20mA signal input.
PM		115 - 230V AC power supply with full sensor supply.
PX		Sensor supply not available. Fo-Series can be powered with 8 - 30V DC. F1-Series can be powered by output loop (type AP), voltage: 8 - 30V DC.

Temperature - additional inputs





Available for the F1-Series only: several products require additional inputs with following functionality.

TA		(0)4 - 20mA input for temperature measurement.
TP		PT100 input for temperature measurement - 2 or 3 wire.
TU		0 - 10V DC input for temperature measurement.
TX		No additional input.







Hazardous area

All models can be supplied Intrinsically Safe with ATEX Certification. For the Fo-Series IECEx, CSA and FM approval as well as non-incendive approval are expected to become available during 2006. For detailed information and latest information, please consult the datasheet and certificate of the product.

XF		ATEX - EExd flameproof enclosure  II 2 GD EEx d IIB T ₅ .
XI		ATEX - Intrinsically Safe:  II 1 GD EEx ia IIB/IIC T ₄ T ₁₀₀ °C.
XN		Non incendive: Expected fourth quarter 2006.
XX		Safe area application.

Other options

Several other options are listed below. Please be aware that more than one of these options can be selected.

ZB		Bi-color backlight green/amber. In case of a monitoring application, the backlight can be set to switch to red in case of an alarm condition. <i>Note: for the F1-Series, only a green backlight for safe area applications is available at this moment.</i>
ZF		Extra high sensitivity for the sine wave (coil) input 10mV p-p.
ZG		Very high sensitivity for the sine wave (coil) input 5mV p-p.
ZV		PT100 (PRTD) range -200°C to +800°C (-328°F to +1472°F).
ZX		No additional option.

ENCLOSURES

The following pages contain dimensional drawings of the F-Series enclosures and mounting accessories.

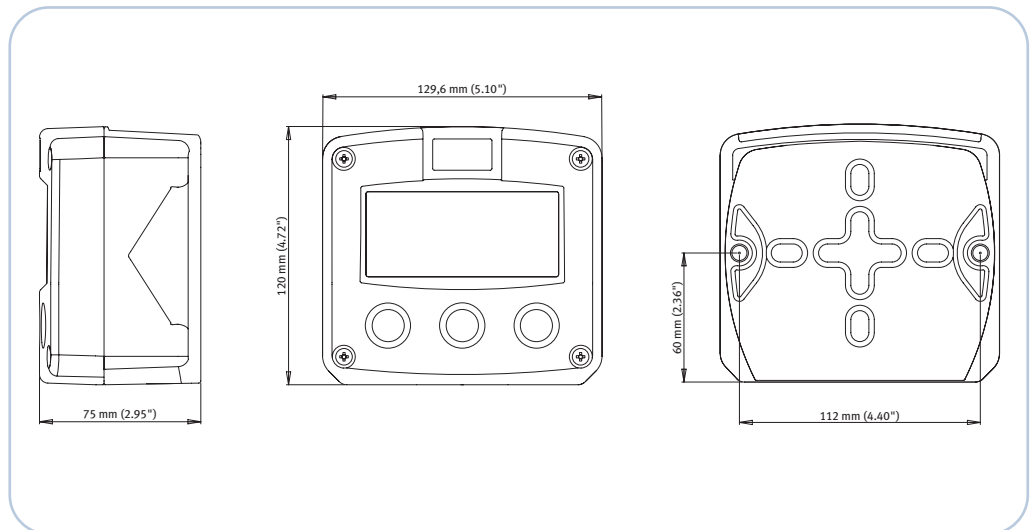

Field / wall mount enclosures, IP67 / NEMA4X

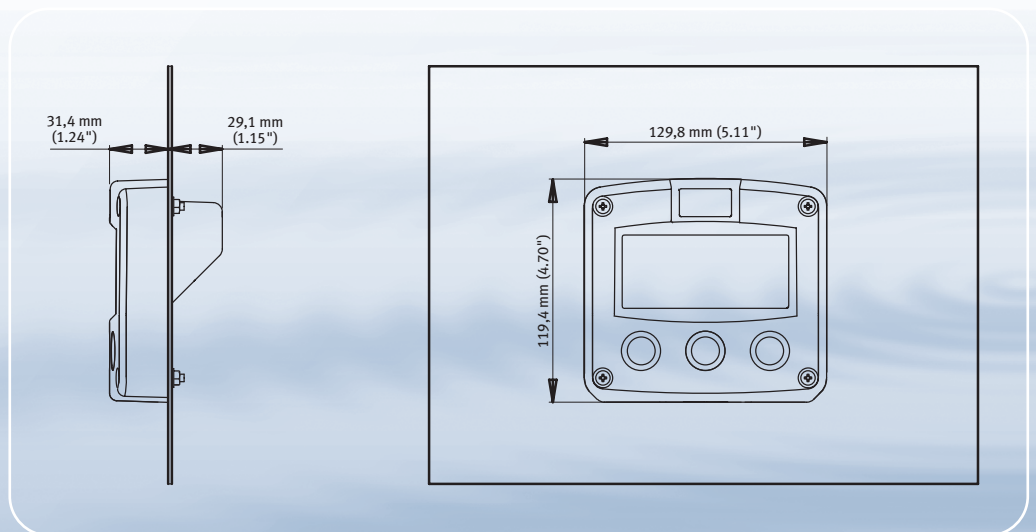

Panel mount enclosures, IP65 / NEMA4

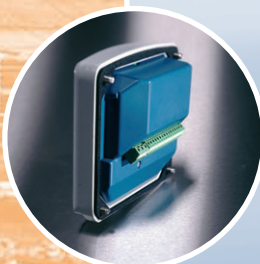

Panel mounting

A major advantage of using the F-Series as a panel mount unit is the minimum depth clearance required. This allows a small box being used compared to many other panel mount devices.

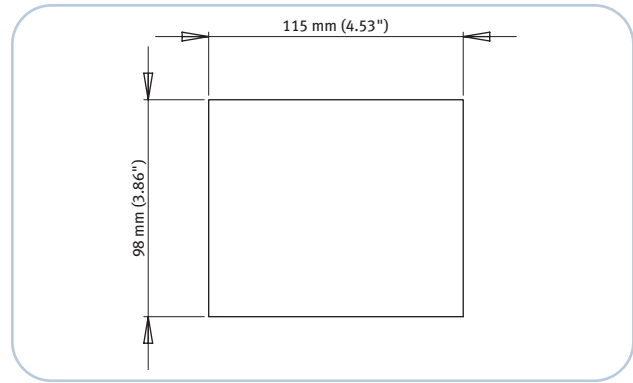

Panel mount cut-out dimensions

Panel cut-out

The panel cut-out can be rectangle where the four bolts will be located in the corners.



Mounting the enclosure in a panel

The enclosure is supplied with four stainless steel bolts, O-rings, washers and nuts.



F-Series mounted in the cabinet

After installing the unit, the thick silicon gasket does assure a proper sealing.



Wall mounting

The F-Series enclosures can be mounted onto the wall in two ways: with and without a mounting plate. Proper screws or bolts have to be used as the weight of the aluminum enclosure is about 1kg and the GRP enclosure about 0.5 kg.

Mounting **without** a mounting plate;

Two holes have to be drilled horizontally to place 6mm (0.23") screws or bolts.

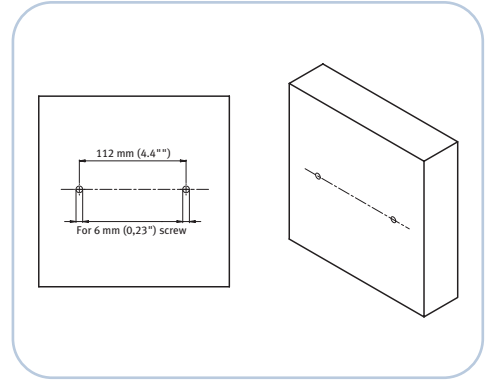

Mounting **with** a mounting plate

The stainless steel mounting plate does make the installation easier. It includes two proper fixed M6 stainless steel bolts with nuts and a large position to fix a tagplate with 3mm (0.11") screws.

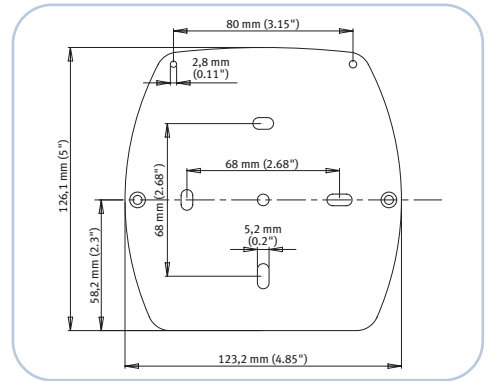

Placing the mounting plate

Two or four holes have to be drilled horizontally and/or vertically, suitable for 5mm (0.2") screws or bolts.



Placing the wall mount enclosure

Simply place the unit and fix it with the two stainless steel washers and M6 nuts provided.



Pipe mounting

The F-Series enclosures can be mounted on any horizontal or vertical pipe from 54,8mm (2") diameter with the stainless steel pipe mounting kit. Proper clamps have to be used as the total weight including the aluminum enclosure is about 1,4 kg and including the GRP enclosure about 0,9 kg. On the top of the mounting plate, a space is provided to place a proper tagplate with 3mm (0.11") screws.

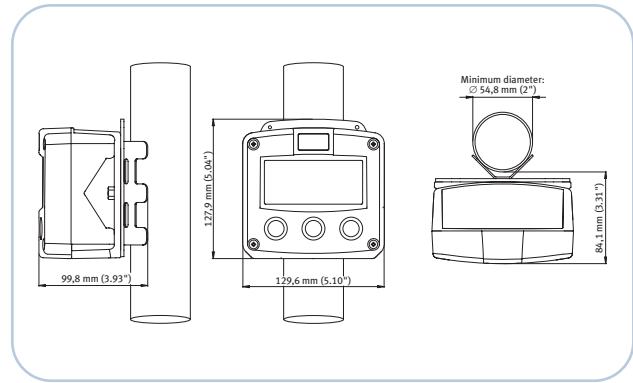

Assembling the pipe mounting kit

The mounting kit includes three stainless steel M5 bolts to fix the pipe mounting bracket horizontally or vertically on the mounting plate. When assembled, the part can easily be fixed on the pipe with the stainless steel worm gear clamps.



Placing the field mount enclosure

Simply place the unit and fix it with the two stainless steel washers and M6 nuts provided.



ACCESSORIES

The following pages contain several accessories, which are available for the F-Series.



Mounting accessories

ACF02	Stainless steel wall mounting kit includes screws and plugs.
ACF05	Stainless steel pipe mounting kit (worm gear clamps not included).
ACF06	Two stainless steel worm gear clamps Ø 44 - 56mm (1.73" - 2.20").
ACF07	Two stainless steel worm gear clamps Ø 58 - 75mm (2.29" - 2.95").
ACF08	Two stainless steel worm gear clamps Ø 77 - 95mm (3.04" - 3.74").
ACF09	Two stainless steel worm gear clamps Ø 106 - 138mm (4.18" - 5.43").
ACF10	Customized Grevopal tagplates for ACF02 and ACF05, including stainless steel screws. Dimension: 95mm x 12.5mm (3.75" x 0.5").

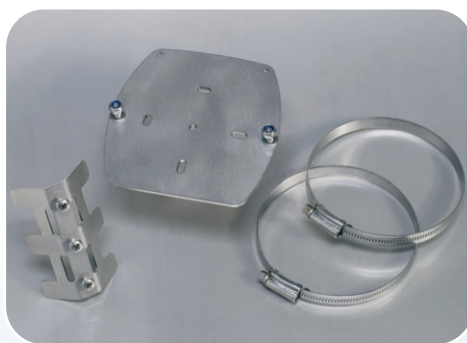

Stainless steel pipe mounting kit

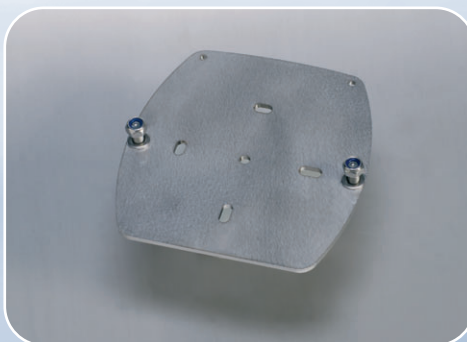

Stainless steel wall mounting kit

Cable gland accessories

ACF20	for HA enclosure: 2 x PG9, 1 x M20 includes O-rings - IP67 / NEMA 4X.
ACF25	for HE enclosure: 2 x M16, 1 x M20 includes locknuts and O-rings - IP67 / NEMA 4X.
ACF26	for HF enclosure: 1 x M20 includes locknut and O-ring - IP67 / NEMA 4X.
ACF27	for HG enclosure: 2 x M20 includes locknuts and O-rings - IP67 / NEMA 4X.
ACF28	for HH enclosure: 6 x M12 includes locknuts and O-rings - IP67 / NEMA 4X.
ACF32	for HM enclosure: 2 x M16, 1 x M20 - includes O-rings - IP67 / NEMA 4X.
ACF33	for HN enclosure: 1 x M20 - includes O-ring - IP67 / NEMA 4X.
ACF34	for HO enclosure: 2 x M20 - includes O-rings - IP67 / NEMA 4X.
ACF35	for HP enclosure: 6 x M12 - includes O-rings - IP67 / NEMA 4X.
ACF39	for HT enclosure: 1 x 1/2" NPT - includes O-ring - IP67 / NEMA 4X.
ACF40	for HU enclosure: 3 x 1/2" NPT - includes O-rings - IP67 / NEMA 4X.



Cable glands

Blind plug accessories

ACF50	for HA enclosure: 2 x PG9, 1 x M20 includes O-rings - IP67 / NEMA 4X.
ACF55	for HE enclosure: 2 x M16, 1 x M20 includes locknuts and O-rings - IP67 / NEMA 4X.
ACF56	for HF enclosure: 1 x M20 includes locknut and O-ring - IP67 / NEMA 4X.
ACF57	for HG enclosure: 2 x M20 includes locknuts and O-rings - IP67 / NEMA 4X.
ACF58	for HH enclosure: 6 x M12 includes locknuts and O-rings - IP67 / NEMA 4X.
ACF62	for HM enclosure: 2 x M16, 1 x M20 - includes O-rings - IP67 / NEMA 4X.
ACF63	for HN enclosure: 1 x M20 - includes O-ring - IP67 / NEMA 4X.
ACF64	for HO enclosure: 2 x M20 - includes O-rings - IP67 / NEMA 4X.
ACF65	for HP enclosure: 6 x M12 - includes O-rings - IP67 / NEMA 4X.
ACF69	for HT enclosure: 1 x 1/2" NPT - includes O-rings - IP67 / NEMA 4X.
ACF70	for HU enclosure: 3 x 1/2" NPT - includes O-rings - IP67 / NEMA 4X.



Blind plugs

Intrinsically Safe isolators accessories

Ordering code		Description	Hazardous area	Safe area
ACG01	MTL5011B	One channel pulse or switch output transfer from hazardous area to safe area, including power supply.	type OT: passive transistor	1 mechanic make-and-break relay
ACG02	MTL5025	One channel power supply from safe area to hazardous area (e.g. to power the unit with type PD or to power a switching or analog device in hazardous area).	device to be powered	20 - 35V DC
ACG03	MTL5042	One channel 4 - 20mA repeater from hazardous area to safe area, including power supply.	type AP / AF: passive analog output	floating 4 - 20mA
ACG04	MTL5051	Bi-direction serial-data isolator (for Modbus communication).	type CT: TTL	RS232, RS422 or TTL
ACG05	MTL5018	Two channel pulse or switch output transfer from hazardous area to safe area, including power supply.	type OT: transistor	2 mechanic make-and-break relays
ACG06	MTL5012	One channel pulse or switch output transfer from hazardous area to safe area, including power supply.	type OT: passive transistor	floating solid state
ACG07	MTL5045	One channel isolated driver bringing 4 - 20mA from safe area to hazardous area, including power supply.	active 4 - 20mA	4 - 20mA



MTL isolators

Functional product overview

	Flow rate / Totalizers							Flow Computers							Batch Controllers				Temperature Indicators				Pressure Indicators				Level Indicators				General Purpose Displays																									
	F010	F011	F012	F014	F110	F111	F115	linearization			hi/lo alarms				F126-EL	F126-EG	F128	ratio	differential / sum	F030	F130	F131	F133	F134	F136	F040	F141	F043	F143	F050	F151	F053	F153	F070	F074	F073	F170	F077	F173	F090	F193	F195	F197													
	flow rate indicator with very large digits	totalizer	flow rate / totalizer	with pulse output	pulse and analog outputs	2 signal inputs	2 pulse outputs	bi-directional measurement	with pulse output	pulse and analog outputs	analog + pulse output	two flow rate alarms	flow rate monitoring one alarm output	flow rate monitoring max. 4 alarm outputs	totalizer monitor with alarm + analog output	flow + temperature for liquid volume calc.	flow + temp. + press. for gas volume calc.	energy consumption calculation	ratio calculation and monitoring	consumption / sum calculation	consumption calc. with temp. correction	with one control output	two control or pulse outputs	2 control/pulse + analog output	delivery controller	analog output for smooth multi-stage valve control	2 control / pulse + analog output	temperature indicator with very large digits	dual temp. indicator	with one alarm output	analog + maximum 4 alarm outputs	pressure indicator with very large digits	dual pressure indicator	with one alarm output	analog + maximum 4 alarm outputs	level indicator with very large digits	with one on/off pump/valve control output	with one alarm output	analog + maximum 4 alarm outputs	with one alarm output	analog + maximum 4 alarm outputs	loop powered indicator with very large digits	modbus display with analog + control output	valve position indicator	setpoint generator with analog output											
(0)4 - 20mA input	●	●	●	●	●	●		●	●	●	●	●	●	●	●	●	●	●	●	●	●	●	●	●	●	●	●	●	●	●	●	●	●	●	●	●	●	●	●	●	●	●	●	●	●	●										
Thermocouple input															●	●	●										●	●																												
Pulse input	●	●	●	●	●	●		●	●	●	●	●	●	●								●	●	●	●	●																			●	●										
PT100 input															●	●	●											●	●	●	●																									
0 - 10V DC input	●	●	●	●	●	●		●	●	●	●	●	●	●	●	●	●					●	●	●	●	●		●	●	●	●	●	●	●	●	●	●	●	●	●	●	●	●	●	●	●	●	●	●	●						
Actual flow rate	●		●	●	●	●	●	●	●	●	●	●	●	●	●	●	●						●	●																			●			●	●									
Actual total (resettable)		●	●	●	●	●	●	●	●	●	●	●	●	●	●	●	●					●	●	●	●	●																														
Accumulated total		●	●	●	●	●	●	●	●	●	●	●	●	●	●	●	●					●	●	●	●	●																														
Preset and/or actual value															●/●							●/●	●/●	●/●			●/●	●/●																	●/●		●/●									
Actual temperature															●	●	●				●						●	●	●	●															●			●	●							
Actual pressure																●												●	●	●	●																●			●	●					
Actual level and/or percentage																		-/●																																						
8 / 15 point linearization								●/-	●/●	●/-																																														
(0)4 - 20mA / 0 - 10V DC output:																																																								
- acc. to flow rate / temperature					●/-		●/-		●/-	●/-		●/-	●/-	●/-	●/-	●/-	●/-							●/-																																
- acc. to pressure / level																																																								
- acc. to differential / sum flow.																																																								
- acc. to ratio / totalizer																																																								
- acc. to process stage / energy																																																								
- control output																																																								
Pulse output acc. to total				●	●	●	●	●	●	●		●	●	●	●	●	●									●																														
High / low alarms																																																								
(1 stage) control output(s)																																																								
2 stage / 8 stage control output																																																								
Overrun correction / no flow alarm																																																								
Temp. / pressure compensation																																																								
Dual input unit / bi-directional						●/-	-/●																																																	
Consumption / sum calculation																																																								
External reset total					●				●			●																																												
External start / stop																																																								
Display with large digits 26mm(1")	●																																																							
RS232 / RS485 / TTL - Modbus					●	●	●		●	●		●	●	●	●	●	●																																							
Intrinsically Safe/explosion proof	●	●	●	●	●	●	●	●	●	●	●	●	●	●	●	●	●	●	●	●	●	●	●	●	●	●	●	●	●	●	●	●	●	●	●	●	●	●	●	●	●	●	●	●	●	●	●	●	●	●	●	●	●	●		
LED backlight	●	●	●	●	●	●	●	●	●	●	●	●	●	●	●	●	●	●	●	●	●	●	●	●	●	●	●	●	●	●	●	●	●	●	●	●	●	●	●	●	●	●	●	●	●	●	●	●	●	●	●	●	●	●	●	●



Fluidwell bv

P.O. Box 6
5460 AA VEGHEL
The Netherlands

Phone +31 (0)413 343 786

Fax +31 (0)413 363 443

sales@fluidwell.com

www.fluidwell.com

Distributor:



Important: specifications are subject to change without notice. Copyright Fluidwell bv - 2011 - FSERIES-CATALOG-EN-V1152