

Advanced Handheld Tachometer

FT-7200

Advanced Handheld Tachometer

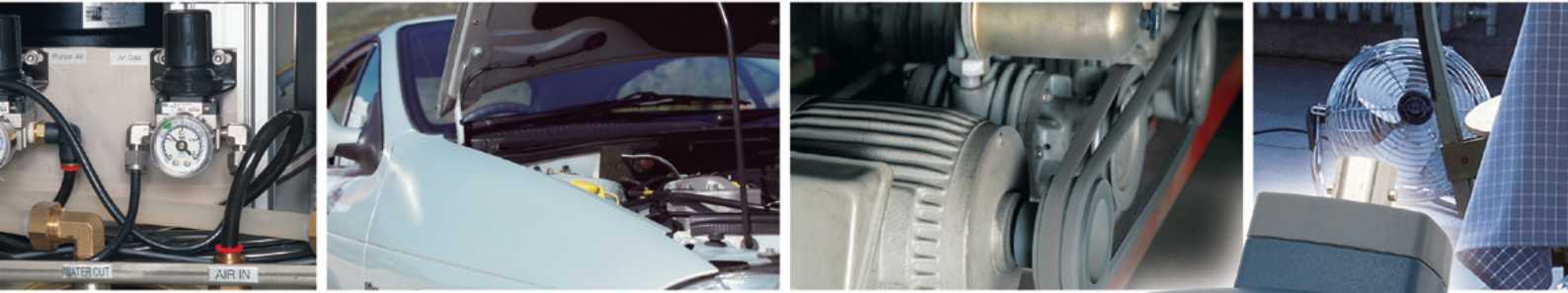

Measures engine rotation speed via a cigarette lighter socket sensor!



Cigarette lighter socket sensor
FT-0801

ONOSOKKI

FT-7200 Advanced Handheld Tachometer

Rotation pulse not needed. Rotation speed measured via light, magnetism, vibration, sound, etc.

Rotation speed measured via sound and vibration!

Measures engine rotation speed via a cigarette lighter socket sensor!



Overview

The FT-7200 is a handheld tachometer that measures rotation speed by performing frequency analysis using FFT calculations.

It can perform non-contact measurement using sound, vibration, and others, without modifying the rotating shaft.

Features

- Enables rotation measurement by sound or vibration. Processing of a rotating shaft is not necessary.
- Improved following up performance of fluctuation, acceleration and deceleration
- Perfect for measuring engine rotation of finished cars, etc.
- Various types of sensors can be used, including cigarette lighter socket sensors
- Pulse output as rotation cycle signal and analog output for recording of rotation speed are provided as standard.
- Large size LCD with backlight for displaying the measured result.
- Equipped with averaging function

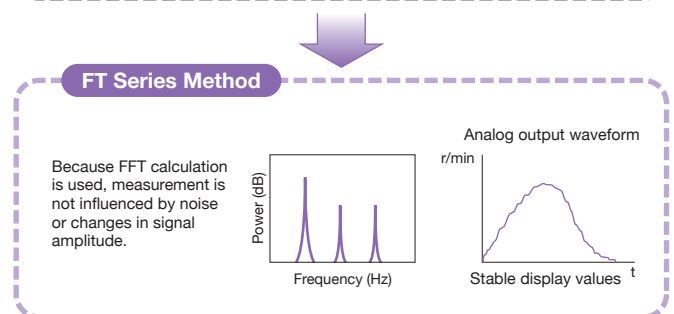
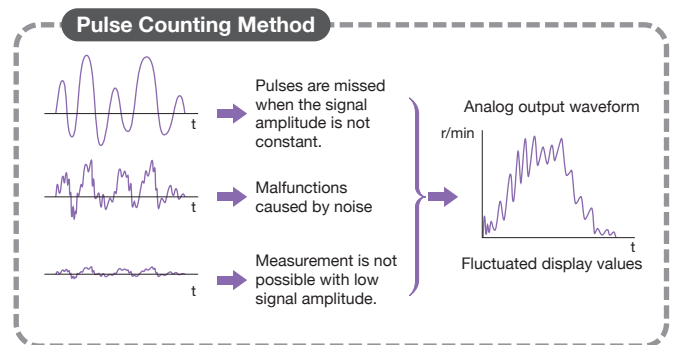

Advanced Handheld Tachometer FT-7200



Algorithms

Five different algorithm modes can be selected to suit your measurement applications.

MODE	Measurement Mode	Measurement Algorithm
A	Steady rotation measurement mode (Constant)	Maximum Power Spectrum Peak Detection Method
B		Peak-Interval Mode Method
C	Acceleration/deceleration rotation measurement mode (Active)	Maximum Power Spectrum Peak Detection Method (Multi-order peak follow up)
D		Maximum Power Spectrum Peak Detection Method (Peak follow up)
E		Maximum Power Spectrum Peak Detection Method (Rotation speed candidate selection)

- C, D, and E modes have improved high follow up performance via faster internal processing.
- Even when the maximum power spectrum peak is lost, the rotation speed is calculated by predicting the expected peak in C mode.
- D mode follows up the maximum power spectrum peak.
- E mode enables the selection of the appropriate rotation speed from up to eight frequency peaks.

Maximum power spectrum peak detection method

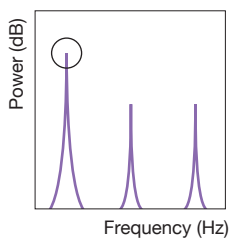

Calculates the frequency of the maximum peak in the power spectrum. Measurement is normally made in this mode.

Peak-interval mode method

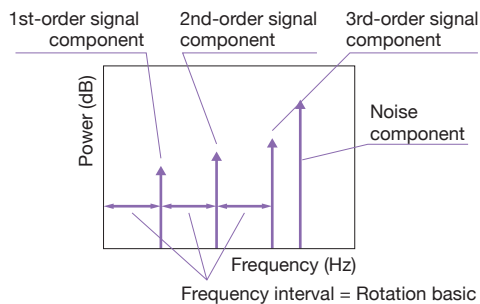

The FT-7200 continually calculates the frequency interval of each rotation order component. It determines the frequency interval that appeared the most as the 1st-order component of the rotation speed, and thereby decides the rotation speed. This method is effective when the 1st-order peak is unstable.

Comparison of new algorithm (C Mode) of the FT-7200 with a previous model

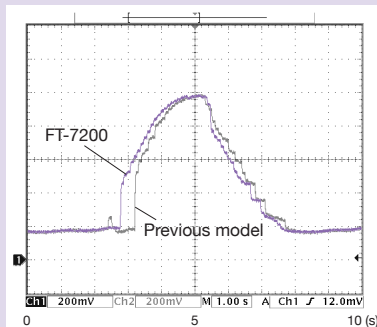
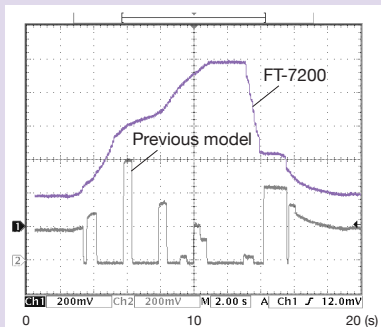

Comparison of new Mode C of the FT-7200 with a previous model

Mode C can be used to measure rotating object that a previous model was unable to measure (see left). The FT-7200 also has improved follow up performance of rapid accelerated and decelerated rotation (see right).

(compared analog outputs by oscilloscope)

Examples of Application

■ Rotation Speed Measurement of DC Motors

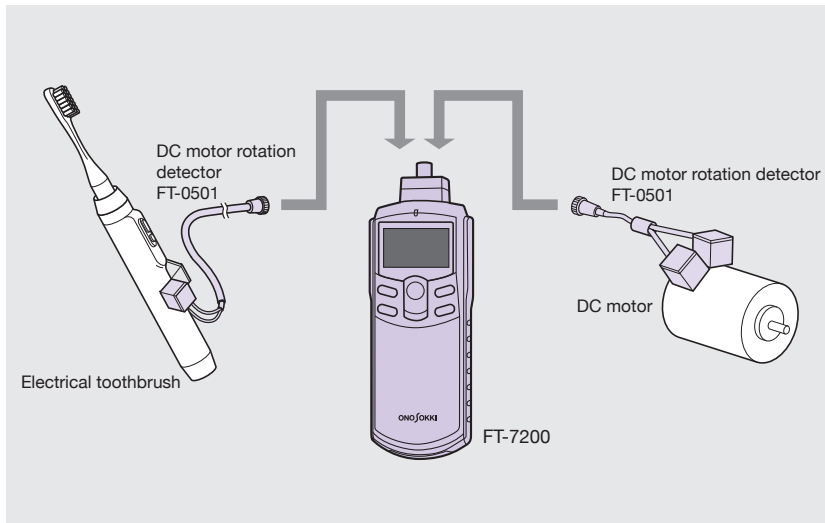

The FT-0501 detects the magnetic flux leakage of a DC motor, and calculates the frequency signal in proportion to rotation speed. This is able to measure the rotation speeds of built-in DC motors.

■ Rotation Speed Measurement of Finished Products

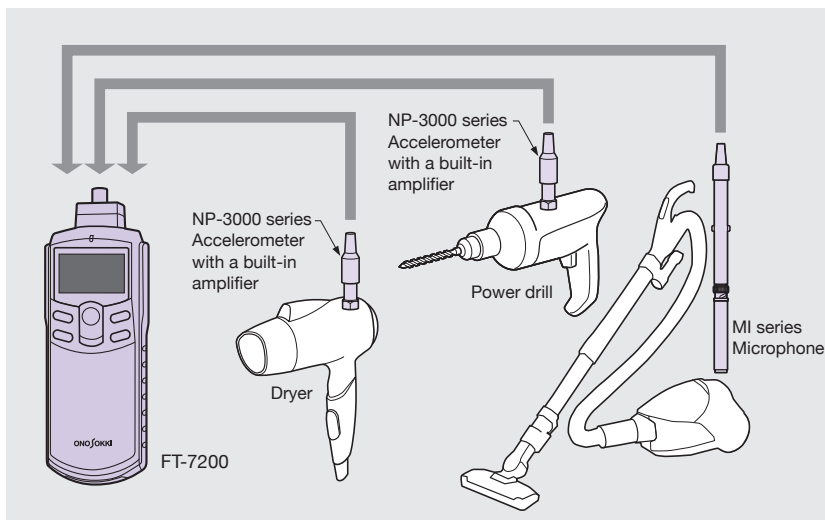

This product can measure the rotation speeds of motors in finished products where the motors are not visible, such as power drills and vacuum cleaners. Measurement is performed with a microphone, making it possible to perform measurement without modifying the measurement object.

■ Rotation Speed Measurement of Fans and Compressors

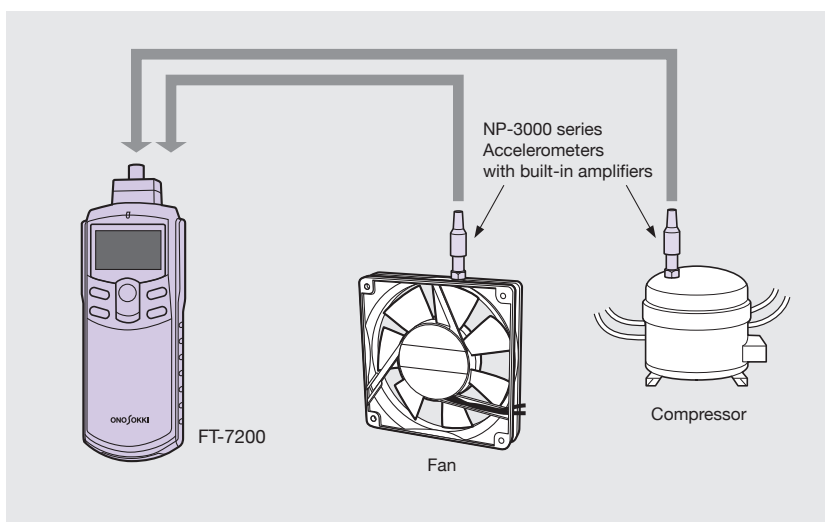

The vibration of a rotating object depends on the rotation movement. The rotation speed of a rotating object can be measured by measuring the vibration frequency.

(Some rotating objects and engines cannot be measured. Please check using the sensors and/or contact your nearest distributor.)

■ Rotation Speed Measurement of Automobiles, Construction Machineries, and Other Engines

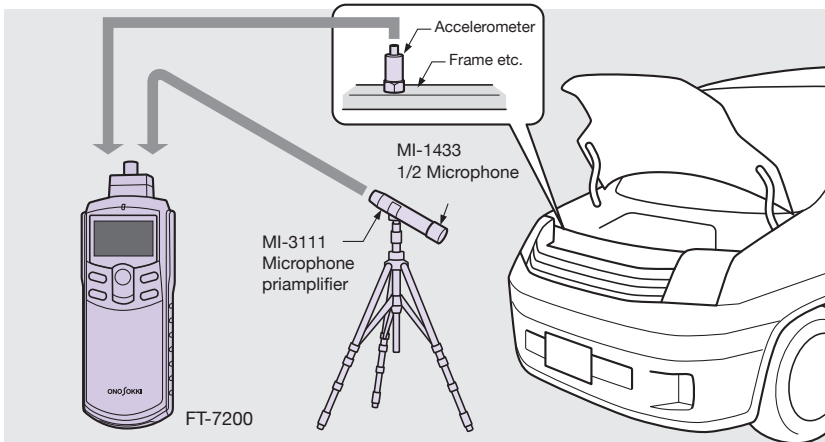

The rotation speed of engines can be measured from noise and vibration caused by the movement of pistons.

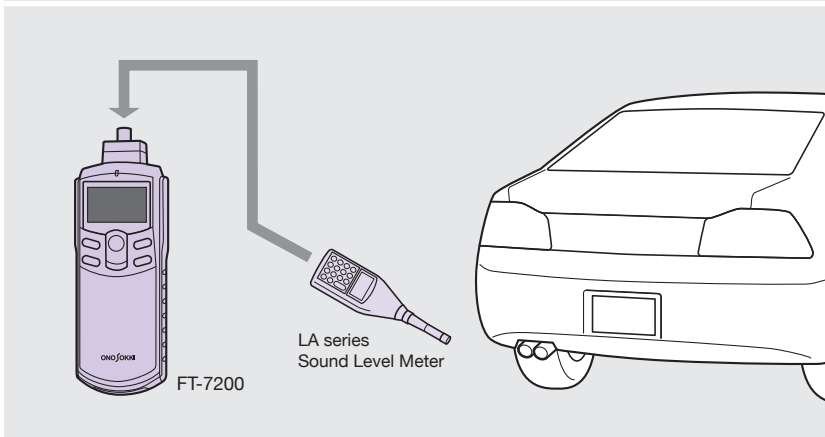

The rotation speed of engines can be measured from the noise of intake and exhaust from a muffler.

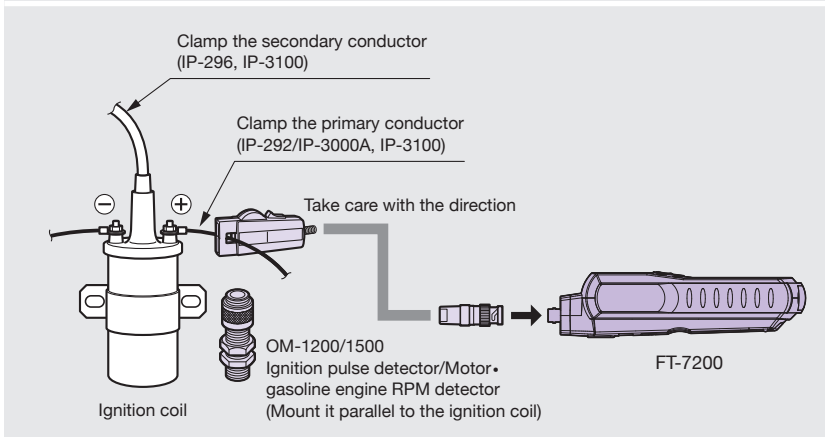



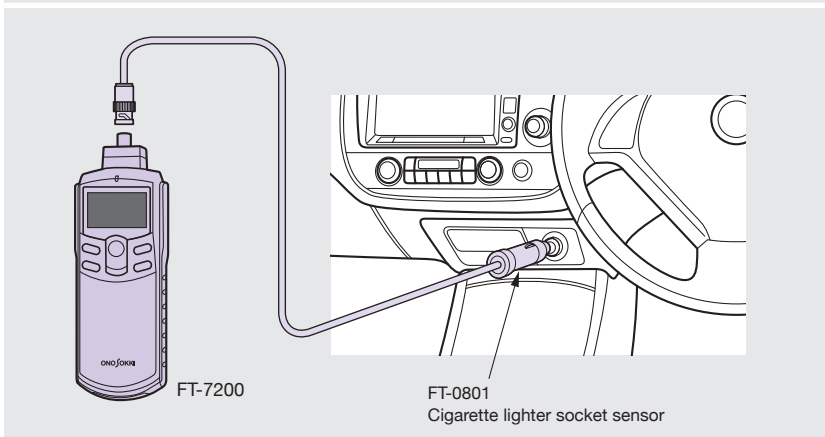



The rotation speed of engines can be measured by clamping sensors to an automobile's primary low-voltage and secondary high-voltage conductors.



Engine Measurement via the FT-0801 Cigarette Lighter Socket Sensor

Connect the FT-0801 to a power outlet equipped on an automobiles or construction machineries. It is possible to measure the rotation speed of engines using the FT-7200 by detecting the ignition noise in the voltage from the power outlet. Supports 12VDC and 24VDC batteries.

System Configuration

Rotation measurement from noise	Rotation measurement from sound	Rotation measurement from vibration		Rotation measurement from ignition pulse of engines		Rotation measurement from magnetism
Cigarette lighter socket sensor  FT-0801	Microphone preamplifier  MI series MI-3111 MI-1433	Accelerometer  NP-2000/3000 series	Engine rotation detector (vibration sensor)  VP-202/1220	Ignition pulse detector/ Motor•gasoline engine RPM detector  IP-292/296 IP-3000A/3100 OM-1500	Ignition pulse detector/ Motor•gasoline engine RPM detector  OM-1200	DC motor rotation detector  FT-0501

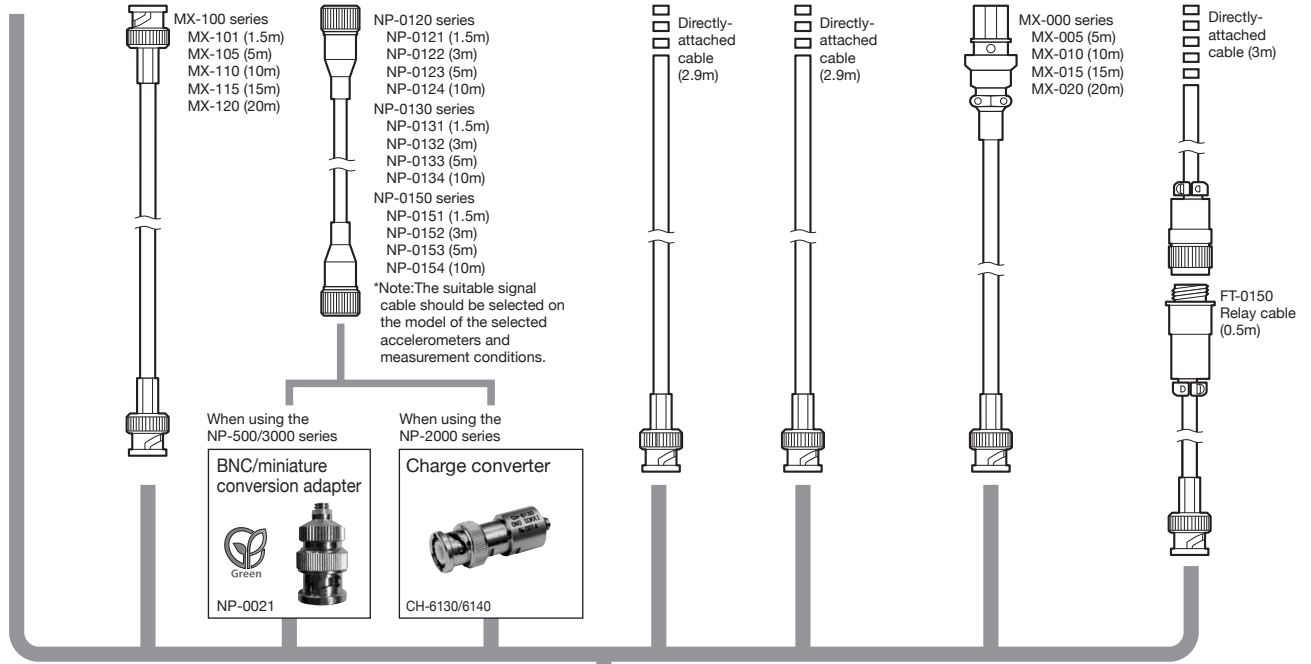

Note: MI series and NP series brochures are available separately.

Direct connection



FT-7200 Advanced Handheld Tachometer

Note: All the peripheral equipments described on this page are sold separately as options.

Pulse output

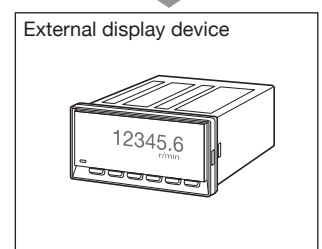
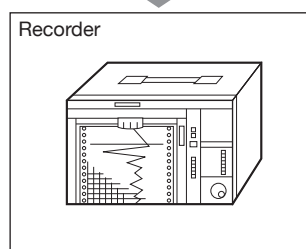
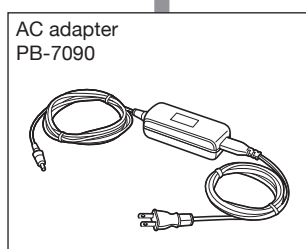

FT-7200 Specification

Measurement section

Measurement objects	DC motors, compressors, engines, and general rotating objects
Calculation method	FFT calculation
Measurement time	250ms or less
Input frequency range	2000Hz range: 30 to 2,000Hz (1,800 to 99,999r/min) *1 500Hz range: 7.5 to 500Hz (450 to 30,000r/min) *1 250Hz range: 3.75 to 250Hz (225 to 15,000r/min) *1 *1 r/min figures above are for 1P/R.
Measurement unit	r/min (rotation speed)
Rotation speed resolution (r/min)	Frequency range (Hz) ÷ 6,400 × 60 ÷ the number of set pulses Frequency range: 250, 500, 2000 (Hz) Set pulse count: 0.5, 1, 1.5, etc. (P/R) 6400: FFT resolution Resolution drops when rotation speed is accelerating or decelerating.
Measurement accuracy (r/min)	±2 × rotation speed resolution (r/min) ±1 Note: The measurement accuracy depends on the frequency range.
Filter function	Limits the target frequency range (rotation speed range) within the selected frequency ranges.
Averaging function	Moving average processing Number of averages: OFF, 2, 4, 8, 16
Sensor amplifier sensitivity adjustment dial	The sensor amplifier's sensitivity can be adjusted via the rotary dial on the right side of the main unit.

Detection section

Applicable detectors	For engine rotation measurement	FT-0801, OM-1200, OM-1500, VP-1220, VP-202, IP-292, IP-296, IP-3000A, IP-3100 NP-3000 series (built-in amplifier), FT-0501, MI-1433 + MI-3111 (microphone), magnetic flux leakage sensor
Input voltage level	5V: Max.±5V, 0.5V: Max.±0.5V, 0.05V: Max. ±0.05V	
Input coupling	AC coupling	
Power supply for NP series sensor	Constant current power supply (2.4 ±0.5mA)	

* Note for measurement: Correct detection may not be possible depending on the type of an engine or an object under measurement.

Display section

Number of display digits	5
Character height	10.2mm
Display device	7-segment LCD with backlight
Display update time	0.5 ±0.2s
Display resolution	1r/min

Measurement Mode

CNS (Constant)	Use when there is low fluctuation in the rotation speed of the measurement object. (when measuring rated rotation speed or similar)	Modes A, B
ACT (Active)	Use when the rotation speed of the measurement object is accelerated and decelerated. (However, it may not be possible to measure correctly if the changes are sudden.)	Modes C, D, E

FT-0801 Specification

Input section

Connector shape	Cigarette lighter socket
Input voltage	12/24 VDC (battery voltage)

Output section

Connector shape	BNC
Filter	High-pass filter

* The FT-0801 is performed AC coupling processing, protecting the FT-7200 from overvoltage.

Output section

[ANALOG] Analog output (selector switch between analog output and analog output for monitor)	
Signal output	Outputs the rotation speed displayed value
Voltage range	0 to 1 V / 0 to F.S. (F.S. can be specified optionally.)
Conversion method	10-bit D/A conversion
Linearity	±1% of F.S.
Output update time	250ms or less
Temperature stability	±0.05% of F.S. /°C (ZERO & SPAN)
Setting error	±0.5% of F.S (Factory default of setting error; ZERO & SPAN)
Load resistance	100kΩ or more
Output connector	Ultra-mini jack (φ2.5)
[ANALOG] Analog output for monitor (selector switch between analog output for monitor and analog output)	
Signal output	Analog output for monitor after waveform shaping of the sensor signal
Load resistance	100 kΩ or more
Output connector	Ultra-mini jack (φ2.5/common to ANALOG output)
[PULSE] Pulse output	
Signal output	Pulse output of power spectrum frequency extracted via FFT processing
Output voltage	Hi: +4.5V or more; Lo: -0.5V or less (when no load)
Output frequency range	3.75Hz to 2kHz Equivalent to displayed rotation speed × set number of pulses per rotation (P/R)
Load resistance	100 kΩ or more
Output connector	Ultra-mini jack (φ2.5/common to ANALOG output)
Output update time	250ms

General Specification

Applicable standard	CE Marking
Power supply	Four type AAA batteries or exclusive AC adapter (PB-7090, sold separately)
Continuous operating time	Approx. 6 hours (with backlight OFF) Approx. 5 hours (with backlight ON) (Using alkaline batteries at 20°C; excludes when an NP-3000 series accelerometer is in use*) *2 Using an NP-3000 series accelerometer increases the current consumption because of constant-current power drive. We therefore recommend using the exclusive AC adapter when an NP-3000 series accelerometer is used.
Battery LOW display	The "LOW" mark lights up at approx. 4.2V.
Operating temperature range	0 to +40°C
Storage temperature range	-10 to +50°C
Operating humidity range	+35 to +85% RH (with no condensation)
Storage humidity range	+35 to +85% RH (with no condensation)
Weight	Approx. 230g (main unit only; not including batteries)
Outer dimensions	189.5(H) × 66.0(W) × 47.5 (D) mm (main unit only)
Accessories	Type AAA alkaline battery × 4, three kinds of instruction manuals (one copy each), carrying case

General Specification

Cable length	2m
Operating temperature range	0 to +40°C
Storage temperature range	-10 to +50°C
Weight	Approx. 75g
Outer dimensions	φ22.3 × 69mm

Applicable sensors and options (sold separately)

Cigarette lighter socket sensor FT-0801 	DC motor rotation detector FT-0501 	Ignition pulse detector (primary side) IP-292 	Main unit ● FT-7200 Advanced Handheld Tachometer Detectors ● FT-0801 Cigarette lighter socket sensor ● FT-0501 DC motor rotation detector ● IP-292 Ignition pulse detector (primary side) ● IP-296 Ignition pulse detector (secondary side) ● IP-3000A Ignition pulse detector ● IP-3100 Ignition pulse detector ● OM-1200 Ignition pulse detector/Motor•gasoline engine RPM detector ● OM-1500 Ignition pulse detector/Motor•gasoline engine RPM detector ● VP-202 Engine rotation detector ● VP-1220 Engine rotation detector (high-sensitive type) ● NP-2000 /NP-3000 series Accelerometer ● MI series Microphone + preamplifier Accessories ● HT-0522 Magnetic stand ● HT-0521A Stand jig ● LA-0203C*1 Tripod for sound level meter ● PB-7090*2 AC adapter (input :100 to 240VAC) (output :5.9VDC/3.5A) ● AX-501 Signal cable (2m) (Can be used for analog and pulse outputs.) φ2.5 pin plug – CO2 (BNC) *1: Made by Slik Corporation (splint PRO II GM) *2: Made by Adapter Technology Please specify the specification of an AC cord if needed. AC cord provided as standard is a cord for use in Japan.
Ignition pulse detector (secondary side) IP-296 	Ignition pulse detector IP-3000A 	Ignition pulse detector IP-3100 	
Ignition pulse detector (Motor•gasoline engine RPM detector) OM-1200 	Ignition pulse detector/ (Motor•gasoline engine RPM detector) OM-1500 	Engine rotation detector VP-202 	
Engine rotation detector (high-sensitive type) VP-1220 	Accelerometer NP-2000/3000 series 	Microphone + preamplifier MI series 	
Magnetic stand / stand jig HT-0522/0521A 	Tripod for sound level meter LA-0203C*1 	Signal cable AX-501 	

Outer Dimensions

Unit (mm)

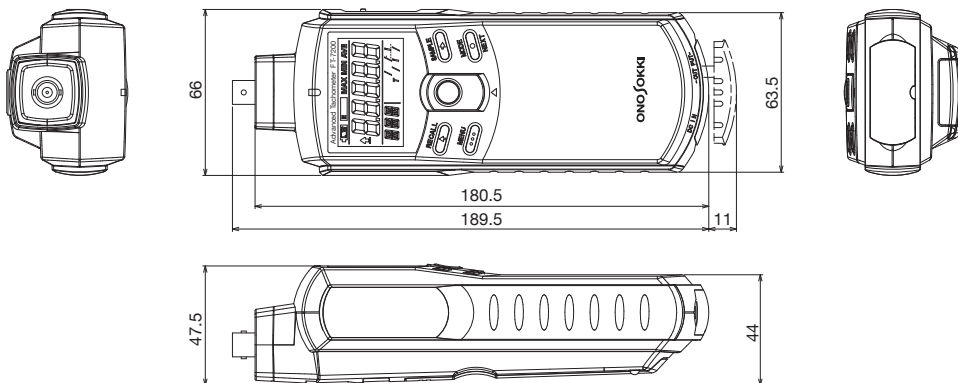

WORLDWIDE ONO SOKKI CO., LTD.

1-16-1 Hakusan, Midori-ku, Yokohama, 226-8507, Japan
 Phone : +81-45-935-3918 Fax : +81-45-930-1808
 E-mail : overseas@onosokki.co.jp

*Outer appearance and specifications are subject to change without prior notice.

URL : <http://www.onosokki.co.jp/English/english.htm>

U.S.A.
 Ono Sokki Technology Inc.
 2171 Executive Drive, Suite 400,
 Addison, IL. 60101 U.S.A.
 Phone : +1-630-627-9700
 Fax : +1-630-627-0004
 E-mail : info@onosokki.net
<http://www.onosokki.net>

THAILAND
 Ono Sokki (Thailand) Co., Ltd.
 1/293-4 Moo.9 T.Bangphud A.Pakkred,
 Nonthaburi 11120, Thailand
 Phone : +66-2-584-6735
 Fax : +66-2-584-6740
 E-mail : sales@onosokki.co.th

INDIA
 Ono Sokki India Private Ltd.
 Plot No.20, Ground Floor, Sector-3,
 IMT Manesar Gurgaon-122050,
 Haryana, INDIA
 Phone : +91-124-421-1807
 Fax : +91-124-421-1809
 E-mail : osid@onosokki.co.in

P.R.CHINA
 Ono Sokki Shanghai Technology Co., Ltd.
 Room 506, No.47 Zhengyi Road, Yangpu
 District, Shanghai, 200433, P.R.C.
 Phone : +86-21-6503-2656
 Fax : +86-21-6506-0327
 E-mail : admin@shonosokki.com