

# HIGH VOLTAGE RESISTORS

PRECISION – PULSE – POWER

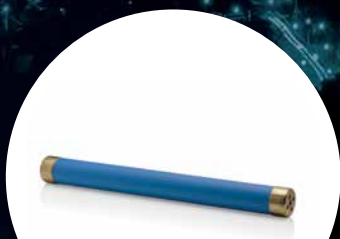

▶ HVR 969

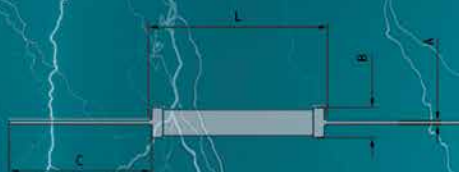
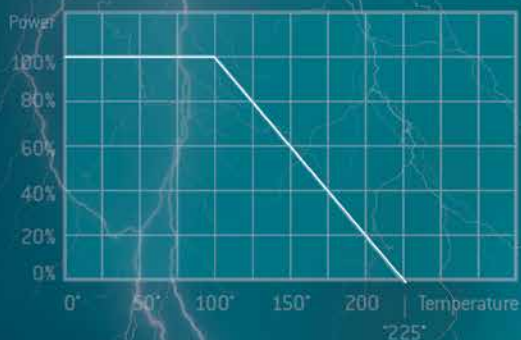

▶ POC 400

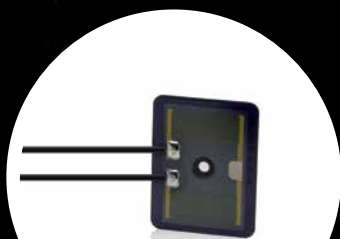

▶ PLR/PLR-T0

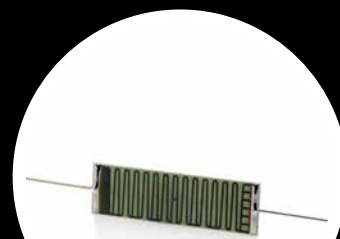

▶ HVR 967

FIRST IN SENSORS

metallux USA, Inc.

# TRUST THE X!

## Welcome to Metallux USA, Inc.

Metallux USA, Inc. is the sole distributor of products for Metallux AG in Germany. A company that is internationally renowned for its sensor products.

We are located in Western New York State in the city of Rochester on the southern shore of Lake Ontario. The City is the home of internationally-recognized academic institutions like the University of Rochester and Rochester Institute of Technology. Metallux USA, by virtue of our sole relationship status with Germany, allows us to possess a direct line of communication with the head office in Germany. This line provides customer and potential customers the ability to receive prompt and accurate answers to all of their technical inquire.

Whether you are interested in industrial joysticks, pressure sensors, linear or rotary measurement sensors, high voltage and power or brake resistor, Metallux USA Inc. is always your first choice for a successful, satisfactory and well executed solution for all your sensor applications.



 BERND H. OBERASCHER  
President Metallux USA, Inc.



 **OUR GUIDELINE:** Fair partnership will ensure a successful and lasting business relationship. We pride ourselves in individual and direct consultation resulting in an innovative product range and reliability.

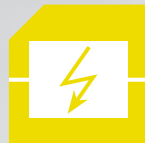
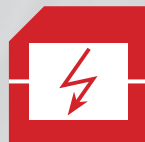
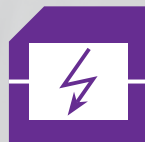
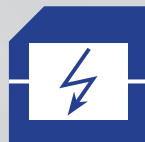
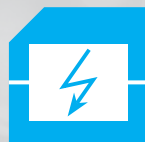
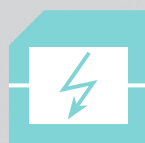

 Whether standard resistors or custom solutions: Our high voltage resistors are employed in numerous fields, such as solar and medical technology, transformer equipment and much more

**HVR**High voltage resistors  
Type series 967, 968, 969**HPR**High voltage precision resistors  
Type series 967, 968, 969**HVI**High voltage pulse resistors  
Type series 967, 968, 969**HVD**High voltage dividers  
Type series 967, 968, 969**NW**Resistor networks  
Type series 967**HVS**High voltage SMD resistors  
Type series 967**POC**High voltage potentiometers  
Type series 400**PLR**Power resistors  
Type series 100, 200, 300, 900New from Metallux  
Applications

# HIGH VOLTAGE RESISTORS HVR 967



With their variety of designs, thick-film high voltage resistors offer ideal possibilities for mastering measuring, controlling and regulating processes in high voltage applications. Whether for high voltage pulses or for registering constant high voltages – with our HVR basic program we offer the ideal solution for all applications in high voltage engineering, high voltage network components, medical technology, electrostatics, the automotive industry and traffic engineering.

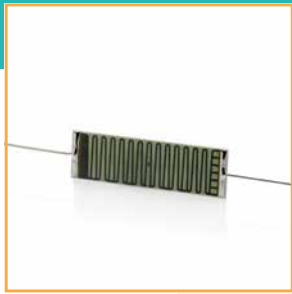

Axial wire connection

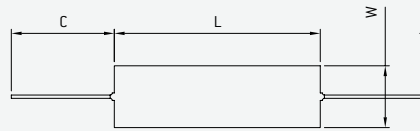

Radial wire connection

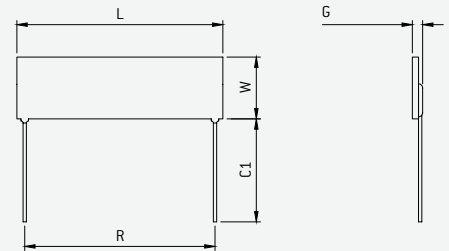

Optional contact PIN

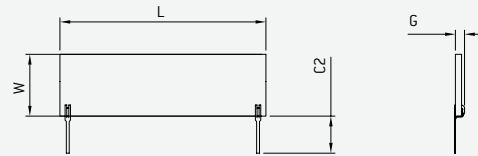

- Flat designs
- Pulse-proof
- Low inductance

## GENERAL TECHNICAL SPECIFICATIONS

<b>Resistance values, standard</b>	5 K, 10 K, 100 K, 1 M, 5 M, 10 M, 25 M, 50 M, 100 M, 1 G, 2 G, 5 G
<b>Tolerance</b>	1 % (0.5 % to 20 %)*
<b>Temperature coefficient</b>	100 ppm/°C (25 ppm/°C to 200 ppm/°C)*
<b>Voltage coefficient</b>	<2 ppm/V
<b>Insulation resistance</b>	>10,000 MΩ (500 V 25 °C 75 % relative humidity)
<b>Dielectric strength of the insulation</b>	>1,000 V (25 °C 75 % relative humidity) ΔR/R 0.25 % max.
<b>Thermal shock</b>	ΔR/R 0.25 % max.
<b>Overload capacity</b>	1.5 x P[nom], 5s (not 1.5 x V[max])
<b>Moisture resistance</b>	ΔR/R 0.25 %
<b>Long-term stability</b>	ΔR/R 0.25 % max.
<b>Temperature range (operation / storage)</b>	−55 °C to +175 °C (−55 °C to +100 °C)
<b>Cover</b>	Epoxy-based varnishes (glass, silicone-based encasing)
<b>Connection type</b>	Connection wires Ø 0.8, tinned Cu, axial or radial (optionally Ø 0.5 silvered Cu or PIN)

Depending on ambient conditions, the characteristics of resistors can change. We recommend a suitability test under operational conditions.

\* Other values upon request.

TYPE SELECTION							
TYPES	TCR (ppm/°C)	0.50 %	1 %	2 %	5 %	10 %	20 %
967.3.25 1 W 8 kV (air) 12 kV (oil)	25	5 K-2 G	2 K-2 G	2 K-2 G	2 K-2 G	2 K-2 G	2 K-2 G
	50	5 K-2 G	2 K-2 G	2 K-2 G	2 K-2 G	2 K-2 G	2 K-2 G
	100	5 K-2 G	2 K-2 G	2 K-2 G	2 K-2 G	2 K-2 G	2 K-2 G
	200	5 K-2 G	2 K-2 G	2 K-2 G	2 K-2 G	2 K-2 G	2 K-2 G
967.3.38 1.5 W 10 kV (air) 15 kV (oil)	25	4 K-500 M	4 K-3 G	4 K-3 G	4 K-3 G	4 K-3 G	4 K-3 G
	50	4 K-500 M	4 K-3 G	4 K-3 G	4 K-3 G	4 K-3 G	4 K-3 G
	100	4 K-500 M	4 K-3 G	4 K-3 G	4 K-3 G	4 K-3 G	4 K-3 G
	200	4 K-500 M	4 K-3 G	4 K-3 G	4 K-3 G	4 K-3 G	4 K-3 G
967.5.13 1.0 W 5 kV (air) 7.5 kV (oil)	25	3 K-500 M	2 K-1 G	2 K-1 G	2 K-1 G	2 K-1 G	2 K-1 G
	50	3 K-500 M	2 K-1 G	2 K-1 G	2 K-1 G	2 K-1 G	2 K-1 G
	100	3 K-500 M	2 K-1 G	2 K-1 G	2 K-1 G	2 K-1 G	2 K-1 G
	200	3 K-500 M	2 K-1 G	2 K-1 G	2 K-1 G	2 K-1 G	2 K-1 G
967.7.51 2 W 20 kV (air) 30 kV (oil)	25	10 K-400 M	5 K-5 G	5 K-5 G	5 K-5 G	5 K-5 G	5 K-5 G
	50	10 K-400 M	5 K-5 G	5 K-5 G	5 K-5 G	5 K-5 G	5 K-5 G
	100	10 K-400 M	5 K-5 G	5 K-5 G	5 K-5 G	5 K-5 G	5 K-5 G
	200	10 K-400 M	5 K-5 G	5 K-5 G	5 K-5 G	5 K-5 G	5 K-5 G
967.8.26 2 W 10 kV (air) 15 kV (oil)	25	10 K-1 G	5 K-2 G	5 K-2 G	5 K-2 G	5 K-2 G	5 K-2 G
	50	10 K-1 G	5 K-2 G	5 K-2 G	5 K-2 G	5 K-2 G	5 K-2 G
	100	10 K-1 G	5 K-2 G	5 K-2 G	5 K-2 G	5 K-2 G	5 K-2 G
	200	10 K-1 G	5 K-2 G	5 K-2 G	5 K-2 G	5 K-2 G	5 K-2 G
967.13.38 3 W 15 kV (air) 30 kV (oil)	25	10 K-1 G	10 K-5 G	10 K-5 G	10 K-5 G	10 K-5 G	10 K-5 G
	50	10 K-1 G	10 K-5 G	10 K-5 G	10 K-5 G	10 K-5 G	10 K-5 G
	100	10 K-1 G	10 K-5 G	10 K-5 G	10 K-5 G	10 K-5 G	10 K-5 G
	200	10 K-1 G	10 K-5 G	10 K-5 G	10 K-5 G	10 K-5 G	10 K-5 G
967.15.30 3 W 15 kV (air) 30 kV (oil)	25	10 K-1 G	10 K-5 G	10 K-5 G	10 K-5 G	10 K-5 G	10 K-5 G
	50	10 K-1 G	10 K-5 G	10 K-5 G	10 K-5 G	10 K-5 G	10 K-5 G
	100	10 K-1 G	10 K-5 G	10 K-5 G	10 K-5 G	10 K-5 G	10 K-5 G
	200	10 K-1 G	10 K-5 G	10 K-5 G	10 K-5 G	10 K-5 G	10 K-5 G
967.15.51 4.5 W 30 kV (air) 45 kV (oil)	25	20 K-1 G	10 K-5 G	10 K-5 G	10 K-5 G	10 K-5 G	10 K-5 G
	50	20 K-1 G	10 K-5 G	10 K-5 G	10 K-5 G	10 K-5 G	10 K-5 G
	100	20 K-1 G	10 K-5 G	10 K-5 G	10 K-5 G	10 K-5 G	10 K-5 G
	200	20 K-1 G	10 K-5 G	10 K-5 G	10 K-5 G	10 K-5 G	10 K-5 G
967.15.76 5.5 W 35 kV (air) 52 kV (oil)	25	10 K-5 G	20 K-10 G	20 K-10 G	20 K-10 G	20 K-10 G	20 K-10 G
	50	10 K-5 G	20 K-10 G	20 K-10 G	20 K-10 G	20 K-10 G	20 K-10 G
	100	10 K-5 G	20 K-10 G	20 K-10 G	20 K-10 G	20 K-10 G	20 K-10 G
	200	10 K-5 G	20 K-10 G	20 K-10 G	20 K-10 G	20 K-10 G	20 K-10 G
967.25.90 10 W 45 kV (air) 67 kV (oil)	25	20 K-5 G	20 K-10 G	20 K-10 G	20 K-10 G	20 K-10 G	20 K-10 G
	50	20 K-5 G	20 K-10 G	20 K-10 G	20 K-10 G	20 K-10 G	20 K-10 G
	100	20 K-5 G	20 K-10 G	20 K-10 G	20 K-10 G	20 K-10 G	20 K-10 G
	200	20 K-5 G	20 K-10 G	20 K-10 G	20 K-10 G	20 K-10 G	20 K-10 G

Other resistance values and temperature coefficients upon request.

DIMENSIONS							
TYPES	W [width]	C1	G	L [length]	R [raster spacing]	Unit	Weight [g]
967.3.25	3.8 (0.2)	36 (1.42)	2.5 (0.1)	25.4 (1.0)	22.9 (0.9)	mm (inches)	0.70
967.3.38	3.8 (0.15)	36 (1.42)	2.5 (0.1)	38.0 (1.5)	35.7 (1.41)	mm (inches)	0.52
967.5.13	5.0 (0.2)	36 (1.42)	2.5 (0.1)	12.7 (0.5)	10.2 (0.4)	mm (inches)	0.54
967.7.51	7.0 (0.3)	36 (1.42)	2.5 (0.1)	51.9 (2.04)	48.0 (1.89)	mm (inches)	1.60
967.8.26	8.0 (0.31)	36 (1.42)	2.5 (0.1)	25.4 (1.0)	22.5 (0.89)	mm (inches)	0.93
967.13.38	13.0 (0.51)	36 (1.42)	2.5 (0.1)	38.5 (1.52)	36.0 (1.42)	mm (inches)	2.20
967.15.30	15.0 (0.59)	36 (1.42)	2.5 (0.1)	30.0 (1.18)	22.1 (0.87)	mm (inches)	2.00
967.15.51	15.0 (0.59)	36 (1.42)	2.5 (0.1)	50.8 (2.0)	48.3 (1.9)	mm (inches)	3.42
967.15.76	15.5 (0.61)	36 (1.42)	2.5 (0.1)	76.2 (3.0)	73.20 (2.88)	mm (inches)	5.10
967.25.90	25.4 (1.0)	36 (1.42)	2.5 (0.1)	88.9 (3.45)	85.6 (3.37)	mm (inches)	10.0

Optional contact PIN - C2: 9 (0.35)

SAMPLE ORDER					
HVR 967.3.38 Type	A Connections	B Cover	100M Resistance value	1 % Tolerance	TC25 Temperature coefficient
	<b>A = axial*</b>	G = glass	R = Ω	0.5 %	25 ppm/°C
	<b>R = radial*</b>	<b>B = operation in air*</b>	K = KΩ	<b>1.0 %*</b>	50 ppm/°C
	P = PIN	D = operation in oil	M = MΩ	2.0 %	<b>100 ppm/°C*</b>
		U = encasing	G = GΩ	5.0 %	200 ppm/°C
				10.0 %	
				20.0 %	

\* standard

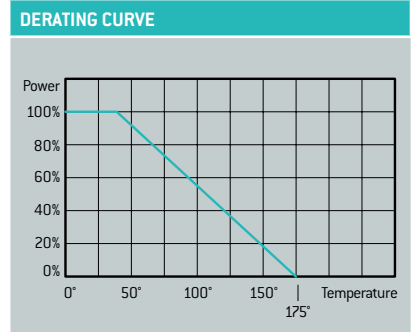

# HIGH VOLTAGE RESISTORS HVR 968



Thick-film high voltage resistors of this type series have been designed specifically for demanding applications. Heavy-duty and with high dielectric strength, these offer the ideal qualities for mastering measuring, controlling and regulating processes. Whether for high voltage pulses or for registering constant high voltages – with our HVR basic program we offer the ideal solution for all applications in X-ray technology, high voltage measuring technology and energy transmission systems.



- Round designs
- Pulse-proof
- Low inductance

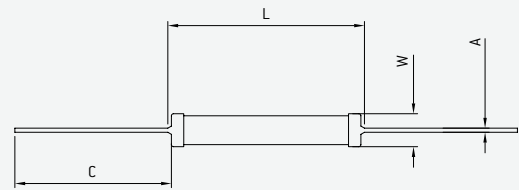

Alternatively threaded end caps

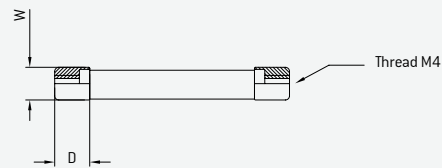

## GENERAL TECHNICAL SPECIFICATIONS

<b>Resistance values, standard</b>	10 K, 100 K, 1 M, 5 M, 10 M, 25 M, 50 M, 100 M, 1 G, 2 G, 5 G*
<b>Tolerance</b>	1 % [0.5 % to 20 %]*
<b>Temperature coefficient</b>	100 ppm/°C [25 ppm/°C to 200 ppm/°C]*
<b>Voltage coefficient</b>	<2 ppm/°C
<b>Insulation resistance</b>	10,000 MΩ [500 V 25 °C 75 % relative humidity]
<b>Dielectric strength of the insulation</b>	>1,000 V [25 °C 75 % relative humidity] ΔR/R 0.25 % max.
<b>Thermal shock</b>	ΔR/R 0.25 % max.
<b>Overload capacity</b>	1.5 x P[nom], 5s [not 1.5 x V[max]]
<b>Moisture resistance</b>	ΔR/R 0.25 %
<b>Long-term stability</b>	ΔR/R 0.25 % max.
<b>Temperature range (operation / storage)</b>	−55 °C to +175 °C [−55 °C to +100 °C]
<b>Cover</b>	Epoxy-based varnishes [glass, silicone-based encasing]
<b>Connection type</b>	Brass caps, wired, optionally with inner thread M4

Depending on ambient conditions, the characteristics of resistors can change. We recommend a suitability test under operational conditions.

\* Other values upon request.

TYPE SELECTION							
TYPES	TOLERANCE						
	TCR (ppm/°C)	0.50 %	1 %	2 %	5 %	10 %	20 %
<b>968.2</b> 3.8 W 9 kV (air) 13.5 kV (oil)	25 50 100 200	60 K – 500 M 9 K – 1 G 9 K – 1 G 9 K – 10 G	60 K – 500 M 9 K – 1 G 9 K – 1 G 9 K – 10 G	60 K – 500 M 9 K – 1 G 9 K – 1 G 9 K – 10 G	60 K – 500 M 9 K – 1 G 9 K – 1 G 9 K – 10 G	60 K – 500 M 9 K – 1 G 9 K – 1 G 9 K – 10 G	60 K – 500 M 9 K – 1 G 9 K – 1 G 9 K – 10 G
<b>968.3</b> 5 W 12 kV (air) 18 kV (oil)	25 50 100 200	80 K – 750 M 6 K – 1.5 G 6 K – 1.5 G 6 K – 15 G	80 K – 750 M 6 K – 1.5 G 6 K – 1.5 G 6 K – 15 G	80 K – 750 M 6 K – 1.5 G 6 K – 1.5 G 6 K – 15 G	80 K – 750 M 6 K – 1.5 G 6 K – 1.5 G 6 K – 15 G	80 K – 750 M 6 K – 1.5 G 6 K – 1.5 G 6 K – 15 G	80 K – 750 M 6 K – 1.5 G 6 K – 1.5 G 6 K – 15 G
<b>968.4</b> 6 W 14 kV (air) 21 kV (oil)	25 50 100 200	80 K – 750 M 10 K – 1.5 G 10 K – 1.5 G 10 K – 15 G	80 K – 750 M 10 K – 1.5 G 10 K – 1.5 G 10 K – 15 G	80 K – 750 M 10 K – 1.5 G 10 K – 1.5 G 10 K – 15 G	80 K – 750 M 10 K – 1.5 G 10 K – 1.5 G 10 K – 15 G	80 K – 750 M 10 K – 1.5 G 10 K – 1.5 G 10 K – 15 G	80 K – 750 M 10 K – 1.5 G 10 K – 1.5 G 10 K – 15 G
<b>968.5</b> 7.5 W 18 kV (air) 27 kV (oil)	25 50 100 200	120 K – 1 G 10 K – 2 G 10 K – 2 G 10 K – 20 G	120 K – 1 G 10 K – 2 G 10 K – 2 G 10 K – 20 G	120 K – 1 G 10 K – 2 G 10 K – 2 G 10 K – 20 G	120 K – 1 G 10 K – 2 G 10 K – 2 G 10 K – 20 G	120 K – 1 G 10 K – 2 G 10 K – 2 G 10 K – 20 G	120 K – 1 G 10 K – 2 G 10 K – 2 G 10 K – 20 G
<b>968.7</b> 10 W 24 kV (air) 36 kV (oil)	25 50 100 200	180 K – 1.5 G 20 K – 3 G 20 K – 3 G 20 K – 30 G	180 K – 1.5 G 20 K – 3 G 20 K – 3 G 20 K – 30 G	180 K – 1.5 G 20 K – 3 G 20 K – 3 G 20 K – 30 G	180 K – 1.5 G 20 K – 3 G 20 K – 3 G 20 K – 30 G	180 K – 1.5 G 20 K – 3 G 20 K – 3 G 20 K – 30 G	180 K – 1.5 G 20 K – 3 G 20 K – 3 G 20 K – 30 G
<b>968.10</b> 12 W 36 kV (air) 54 kV (oil)	25 50 100 200	240 K – 2 G 30 K – 3 G 30 K – 3 G 30 K – 30 G	240 K – 2 G 30 K – 3 G 30 K – 3 G 30 K – 30 G	240 K – 2 G 30 K – 3 G 30 K – 3 G 30 K – 30 G	240 K – 2 G 30 K – 3 G 30 K – 3 G 30 K – 30 G	240 K – 2 G 30 K – 3 G 30 K – 3 G 30 K – 30 G	240 K – 2 G 30 K – 3 G 30 K – 3 G 30 K – 30 G
<b>968.12</b> 15 W 42 kV (air) 63 kV (oil)	25 50 100 200	300 K – 2 G 35 K – 3 G 35 K – 3 G 35 K – 3 G	300 K – 2 G 35 K – 3 G 35 K – 3 G 35 K – 3 G	300 K – 2 G 35 K – 3 G 35 K – 3 G 35 K – 3 G	300 K – 2 G 35 K – 3 G 35 K – 3 G 35 K – 3 G	300 K – 2 G 35 K – 3 G 35 K – 3 G 35 K – 3 G	300 K – 2 G 35 K – 3 G 35 K – 3 G 35 K – 3 G
<b>968.15</b> 17 W 54 kV (air) 81 kV (oil)	25 50 100 200	350 K – 2 G 50 K – 3 G 50 K – 6 G 50 K – 30 G	350 K – 2 G 50 K – 3 G 50 K – 6 G 50 K – 30 G	350 K – 2 G 50 K – 3 G 50 K – 6 G 50 K – 30 G	350 K – 2 G 50 K – 3 G 50 K – 6 G 50 K – 30 G	350 K – 2 G 50 K – 3 G 50 K – 6 G 50 K – 30 G	350 K – 2 G 50 K – 3 G 50 K – 6 G 50 K – 30 G

Other resistance values and temperature coefficients upon request.

DIMENSIONS							
TYPES	A	B [Ø]	C	D	L [length]	Unit	Weight [g]
<b>968.2</b>	0.8 (0.03)	8.0 (0.31)	37.0 (1.46)	8.5 (0.33)	27.0 (1.06)	mm (inches)	4.17
<b>968.3</b>	0.8 (0.03)	8.0 (0.31)	37.0 (1.46)	8.5 (0.33)	37.0 (1.46)	mm (inches)	5.89
<b>968.4</b>	0.8 (0.03)	8.0 (0.31)	37.0 (1.46)	8.5 (0.33)	47.0 (1.85)	mm (inches)	7.65
<b>968.5</b>	0.8 (0.03)	8.0 (0.31)	37.0 (1.46)	8.5 (0.33)	52.0 (2.05)	mm (inches)	8.50
<b>968.7</b>	0.8 (0.03)	8.0 (0.31)	37.0 (1.46)	8.5 (0.33)	78.0 (3.07)	mm (inches)	12.75
<b>968.10</b>	0.8 (0.03)	8.0 (0.31)	37.0 (1.46)	8.5 (0.33)	102.0 (4.06)	mm (inches)	17.34
<b>968.12</b>	0.8 (0.03)	8.0 (0.31)	37.0 (1.46)	8.5 (0.33)	123.0 (4.84)	mm (inches)	20.50
<b>968.15</b>	0.8 (0.03)	8.0 (0.31)	37.0 (1.46)	8.5 (0.33)	153.0 (6.02)	mm (inches)	25.67

Models with brass caps: L<sub>total</sub> = L + 10 mm, Weight: +2.15 g per resistor

SAMPLE ORDER		ATTENTION: PLEASE USE THE FOLLOWING ORDER SPECIFICATIONS.			
HVR 968.5 Type	A Connections	B Cover	100M Resistance value	1 % Tolerance	TC25 Temperature coefficient
	<b>A = wire, axial*</b>	G = glass	R = Ω	0.5 %	25 ppm/°C
	C = caps	<b>B = operation in air*</b>	K = KΩ	<b>1.0 %*</b>	50 ppm/°C
		D = operation in oil	M = MΩ	2.0 %	<b>100 ppm/°C*</b>
		U = encasing	G = GΩ	5.0 %	200 ppm/°C
				10.0 %	
				20.0 %	
					* standard

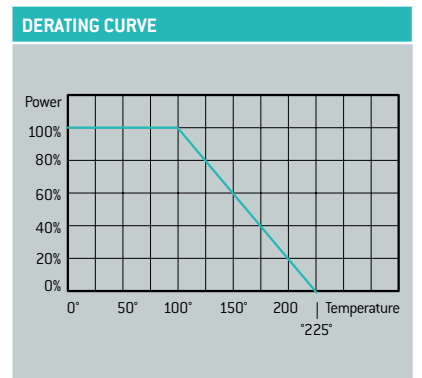

# HIGH VOLTAGE RESISTORS HVR 969



Thick-film high voltage resistors of this type series are especially well-suited for measuring and testing tasks under very high voltages or for use as protective resistors. Whether for high voltage pulses or for registering constant high voltages – with our HVR basic program we offer the ideal solution for all applications in high voltage engineering, energy transmission, insulation testing and traffic engineering.

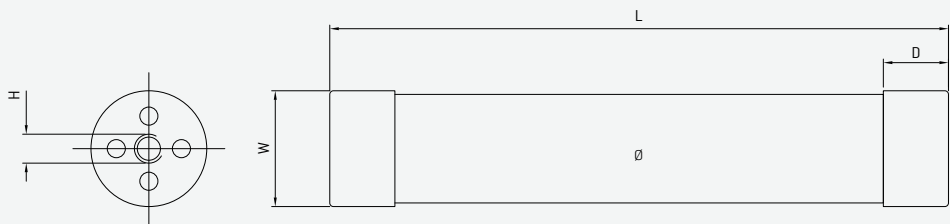

- Round designs
- Pulse-proof
- Low inductance



## GENERAL TECHNICAL SPECIFICATIONS

<b>Resistance values, standard</b>	10 K, 100 K, 1 M, 5 M, 10 M, 25 M, 50 M, 100 M, 1 G, 2 G, 5 G*
<b>Tolerance</b>	1 % [0.5 % to 20 %]*
<b>Temperature coefficient</b>	100 ppm/°C [25 ppm/°C to 200 ppm/°C]*
<b>Voltage coefficient</b>	<2 ppm/°C
<b>Insulation resistance</b>	10,000 MΩ [500 V 25 °C 75 % relative humidity]
<b>Dielectric strength of the insulation</b>	>1,000 V [25 °C 75 % relative humidity] ΔR/R 0.25 % max.
<b>Thermal shock</b>	ΔR/R 0.25 % max.
<b>Overload capacity</b>	1.5 x P[nom], 5s [not 1.5 x V[max]]
<b>Moisture resistance</b>	ΔR/R 0.25 % max.
<b>Long-term stability</b>	ΔR/R 0.25 % max.
<b>Temperature range (operation / storage)</b>	–55 °C to +175 °C [–55 °C to +100 °C]
<b>Cover</b>	Epoxy-based varnishes [glass, silicone-based encasing]
<b>Connection type</b>	Brass caps with inner thread M4 / M8

Depending on ambient conditions, the characteristics of resistors can change. We recommend a suitability test under operational conditions.

\* Other values upon request.



TYPE SELECTION							
TYPES	TCR (ppm/°C)	0.50 %	1 %	2 %	5 %	10 %	20 %
<b>969.11</b> 11 W 24 kV [air] 32 kV [oil]	25 50 100 200	50 K – 500 M 10 K – 1 G 10 K – 1 G 10 K – 5 G	50 K – 500 M 10 K – 1 G 10 K – 1 G 10 K – 5 G	50 K – 500 M 10 K – 1 G 10 K – 1 G 10 K – 5 G	50 K – 500 M 10 K – 1 G 10 K – 1 G 10 K – 5 G	50 K – 500 M 10 K – 1 G 10 K – 1 G 10 K – 5 G	50 K – 500 M 10 K – 1 G 10 K – 1 G 10 K – 5 G
<b>969.23</b> 23 W 48 kV [air] 72 kV [oil]	25 50 100 200	100 K – 1 G 10 K – 1 G 10 K – 1 G 10 K – 10 G	100 K – 1 G 10 K – 1 G 10 K – 1 G 10 K – 10 G	100 K – 1 G 10 K – 1 G 10 K – 1 G 10 K – 10 G	100 K – 1 G 10 K – 1 G 10 K – 1 G 10 K – 10 G	100 K – 1 G 10 K – 1 G 10 K – 1 G 10 K – 10 G	100 K – 1 G 10 K – 1 G 10 K – 1 G 10 K – 10 G
<b>969.54</b> 54 W 48 kV [air] 72 kV [oil]	25 50 100 200	100 K – 1 G 15 K – 1 G 15 K – 1 G 15 K – 10 G	100 K – 1 G 15 K – 1 G 15 K – 1 G 15 K – 10 G	100 K – 1 G 15 K – 1 G 15 K – 1 G 15 K – 10 G	100 K – 1 G 15 K – 1 G 15 K – 1 G 15 K – 10 G	100 K – 1 G 15 K – 1 G 15 K – 1 G 15 K – 10 G	100 K – 1 G 15 K – 1 G 15 K – 1 G 15 K – 10 G
<b>969.71</b> 71 W 64 kV [air] 96 kV [oil]	25 50 100 200	100 K – 1.5 G 25 K – 1.5 G 25 K – 1.5 G 25 K – 15 G	100 K – 1.5 G 25 K – 1.5 G 25 K – 1.5 G 25 K – 15 G	100 K – 1.5 G 25 K – 1.5 G 25 K – 1.5 G 25 K – 15 G	100 K – 1.5 G 25 K – 1.5 G 25 K – 1.5 G 25 K – 15 G	100 K – 1.5 G 25 K – 1.5 G 25 K – 1.5 G 25 K – 15 G	100 K – 1.5 G 25 K – 1.5 G 25 K – 1.5 G 25 K – 15 G
<b>969.105</b> 105 W 96 kV [air] 148 kV [oil]	25 50 100 200	100 K – 2 G 35 K – 2 G 35 K – 2 G 35 K – 25 G	100 K – 2 G 35 K – 2 G 35 K – 2 G 35 K – 25 G	100 K – 2 G 35 K – 2 G 35 K – 2 G 35 K – 25 G	100 K – 2 G 35 K – 2 G 35 K – 2 G 35 K – 25 G	100 K – 2 G 35 K – 2 G 35 K – 2 G 35 K – 25 G	100 K – 2 G 35 K – 2 G 35 K – 2 G 35 K – 25 G

Other resistance values and temperature coefficients upon request.

DIMENSIONS							
TYPES	∅	W	D	H	L [length]	Unit	Weight [g]
<b>969.11</b>	13.0 [0.51]	14.5 [0.57]	10 [0.39]	M4	81.0 [3.19]	mm (inches)	36
<b>969.23</b>	13.0 [0.51]	14.5 [0.57]	10 [0.39]	M4	156.0 [6.14]	mm (inches)	64
<b>969.54</b>	30.5 [1.2]	31.8 [1.25]	18 [0.71]	M8	158.0 [6.22]	mm (inches)	274
<b>969.71</b>	30.5 [1.2]	31.8 [1.25]	18 [0.71]	M8	208.0 [8.19]	mm (inches)	338
<b>969.105</b>	30.5 [1.2]	31.8 [1.25]	18 [0.71]	M8	308.0 [12.13]	mm (inches)	485

SAMPLE ORDER				
HVR 969.23 Type	B Cover	100M Resistance value	1 % Tolerance	TC25 Temperature coefficient
	G = glass	R = Ω	0.5 %	25 ppm/°C
	<b>B = operation in air</b>	K = KΩ	<b>1.0 %</b>	<b>50 ppm/°C</b>
	D = operation in oil	M = MΩ	2.0 %	<b>100 ppm/°C</b>
	U = encasing	G = GΩ	5.0 %	200 ppm/°C
			10.0 %	
			20.0 %	

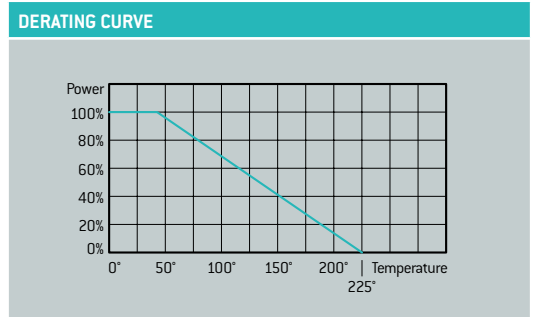

# HIGH VOLTAGE PRECISION RESISTORS HPR 967



High voltage precision resistors were developed specifically for high value measuring tasks. The design provides outstanding features for implementation in devices with extremely high precision and reliable function. HPR high voltage resistors are suitable for all applications in high voltage measuring technology, in mass spectrometers, in high voltage network components and in medical technology.

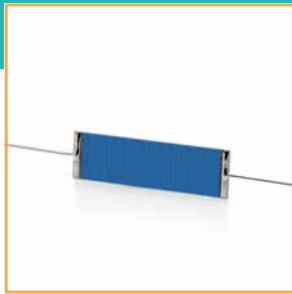

Axial wire connection

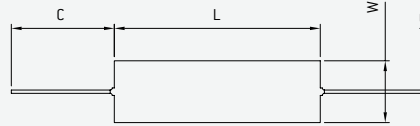

Radial wire connection

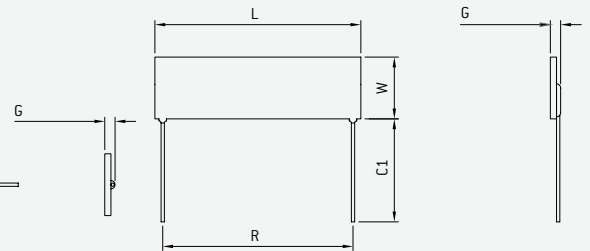

Optional contact PIN

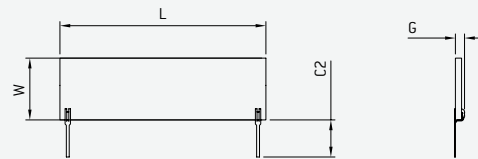

- Flat designs
- Outstanding stability
- Very low inductance
- Minimal drift

## GENERAL TECHNICAL SPECIFICATIONS

<b>Tolerance</b>	0.1 % to 20 %*
<b>Temperature coefficient</b>	15 ppm/°C to 200 ppm/°C*
<b>Voltage coefficient</b>	0.08 ppm/V to 0.75 ppm/V (depending on size and layout)
<b>Insulation resistance</b>	10,000 MΩ (500 V 25 °C 75 % relative humidity)
<b>Dielectric strength of the insulation</b>	>1,000 V (25 °C 75 % relative humidity) ΔR/R 0.25 % max.
<b>Thermal shock</b>	ΔR/R 0.25 % max.
<b>Overload capacity</b>	1.5 x P[nom], 5s (not 1.5 x V[max])
<b>Moisture resistance</b>	ΔR/R 0.25 % max.
<b>Long-term stability</b>	ΔR/R 0.25 % max.
<b>Temperature range (operation / storage)</b>	− 55 °C to +175 °C [− 55 °C to +100 °C]
<b>Cover</b>	Epoxy-based varnishes (glass, silicone-based encasing)
<b>Connection type</b>	Connection wires Ø 0.8, tinned Cu, axial or radial (optionally Ø 0.5 silvered Cu or PIN)

Depending on ambient conditions, the characteristics of resistors can change. We recommend a suitability test under operational conditions.

\* Other values upon request.

TYPE SELECTION									
TYPES	TCR (PPM/°C)	0.1 %	0.25 %	0.5 %	1 %	2 %	5 %	10 %	20 %
967.3.25 0.7 W 8 KV (AIR) 12 KV (OIL)	15/25	5 K-2 G	2 K-2 G	5 K-2 G	2 K-2 G	2 K-2 G	2 K-2 G	2 K-2 G	2 K-2 G
	50	5 K-2 G	2 K-2 G	5 K-2 G	2 K-2 G	2 K-2 G	2 K-2 G	2 K-2 G	2 K-2 G
	100	5 K-2 G	2 K-2 G	5 K-2 G	2 K-2 G	2 K-2 G	2 K-2 G	2 K-2 G	2 K-2 G
	200	5 K-2 G	2 K-2 G	5 K-2 G	2 K-2 G	2 K-2 G	2 K-2 G	2 K-2 G	2 K-2 G
967.3.38 1.0 W 10 KV (AIR) 15 KV (OIL)	15/25	6 K-500 M	6 K-3 G	6 K-500 M	6 K-3 G	6 K-3 G	6 K-3 G	6 K-3 G	6 K-3 G
	50	6 K-500 M	6 K-3 G	6 K-500 M	6 K-3 G	6 K-3 G	6 K-3 G	6 K-3 G	6 K-3 G
	100	6 K-500 M	6 K-3 G	6 K-500 M	6 K-3 G	6 K-3 G	6 K-3 G	6 K-3 G	6 K-3 G
	200	6 K-500 M	6 K-3 G	6 K-500 M	6 K-3 G	6 K-3 G	6 K-3 G	6 K-3 G	6 K-3 G
967.5.13 0.7 W 5 KV (AIR) 7.5 KV (OIL)	15/25	4 K-500 M	4 K-1 G	4 K-500 M	4 K-1 G	4 K-1 G	4 K-1 G	4 K-1 G	4 K-1 G
	50	4 K-500 M	4 K-1 G	4 K-500 M	4 K-1 G	4 K-1 G	4 K-1 G	4 K-1 G	4 K-1 G
	100	4 K-500 M	4 K-1 G	4 K-500 M	4 K-1 G	4 K-1 G	4 K-1 G	4 K-1 G	4 K-1 G
	200	4 K-500 M	4 K-1 G	4 K-500 M	4 K-1 G	4 K-1 G	4 K-1 G	4 K-1 G	4 K-1 G
967.8.26 1.4 W 10 KV (AIR) 15 KV (OIL)	15/25	10 K-1 G	5 K-2 G	10 K-1 G	5 K-2 G	5 K-2 G	5 K-2 G	5 K-2 G	5 K-2 G
	50	10 K-1 G	5 K-2 G	10 K-1 G	5 K-2 G	5 K-2 G	5 K-2 G	5 K-2 G	5 K-2 G
	100	10 K-1 G	5 K-2 G	10 K-1 G	5 K-2 G	5 K-2 G	5 K-2 G	5 K-2 G	5 K-2 G
	200	10 K-1 G	5 K-2 G	10 K-1 G	5 K-2 G	5 K-2 G	5 K-2 G	5 K-2 G	5 K-2 G
967.13.38 2.0 W 15 KV (AIR) 22 KV (OIL)	15/25	15 K-1 G	15 K-5 G	15 K-1 G	15 K-5 G	15 K-5 G	15 K-5 G	15 K-5 G	15 K-5 G
	50	15 K-1 G	15 K-5 G	15 K-1 G	15 K-5 G	15 K-5 G	15 K-5 G	15 K-5 G	15 K-5 G
	100	15 K-1 G	15 K-5 G	15 K-1 G	15 K-5 G	15 K-5 G	15 K-5 G	15 K-5 G	15 K-5 G
	200	15 K-1 G	15 K-5 G	15 K-1 G	15 K-5 G	15 K-5 G	15 K-5 G	15 K-5 G	15 K-5 G
967.15.30 2.0 W 15 KV (AIR) 22 KV (OIL)	15/25	15 K-1 G	15 K-5 G	15 K-1 G	15 K-5 G	15 K-5 G	15 K-5 G	15 K-5 G	15 K-5 G
	50	15 K-1 G	15 K-5 G	15 K-1 G	15 K-5 G	15 K-5 G	15 K-5 G	15 K-5 G	15 K-5 G
	100	15 K-1 G	15 K-5 G	15 K-1 G	15 K-5 G	15 K-5 G	15 K-5 G	15 K-5 G	15 K-5 G
	200	15 K-1 G	15 K-5 G	15 K-1 G	15 K-5 G	15 K-5 G	15 K-5 G	15 K-5 G	15 K-5 G
967.15.51 3.0 W 30 KV (AIR) 45 KV (OIL)	15/25	30 K-1 G	30 K-5 G	30 K-1 G	30 K-5 G	30 K-5 G	30 K-5 G	30 K-5 G	30 K-5 G
	50	30 K-1 G	30 K-5 G	30 K-1 G	30 K-5 G	30 K-5 G	30 K-5 G	30 K-5 G	30 K-5 G
	100	30 K-1 G	30 K-5 G	30 K-1 G	30 K-5 G	30 K-5 G	30 K-5 G	30 K-5 G	30 K-5 G
	200	30 K-1 G	30 K-5 G	30 K-1 G	30 K-5 G	30 K-5 G	30 K-5 G	30 K-5 G	30 K-5 G
967.25.90 8.0 W 45 KV (AIR) 70 KV (OIL)	15/25	50 K-5 G	50 K-10 G	50 K-5 G	50 K-10 G	50 K-10 G	50 K-10 G	50 K-10 G	50 K-10 G
	50	50 K-5 G	50 K-10 G	50 K-5 G	50 K-10 G	50 K-10 G	50 K-10 G	50 K-10 G	50 K-10 G
	100	50 K-5 G	50 K-10 G	50 K-5 G	50 K-10 G	50 K-10 G	50 K-10 G	50 K-10 G	50 K-10 G
	200	50 K-5 G	50 K-10 G	50 K-5 G	50 K-10 G	50 K-10 G	50 K-10 G	50 K-10 G	50 K-10 G

Other resistance values upon request.

DIMENSIONS							
TYPES	W [width]	C1	G	L [length]	R [raster spacing]	Unit	Weight [g]
967.3.25	3.8 [0.2]	36 [1.42]	2.5 [0.1]	25.4 [1.0]	22.9 [0.9]	mm [inches]	0.70
967.3.38	3.8 [0.15]	36 [1.42]	2.5 [0.1]	38.0 [1.5]	35.7 [1.41]	mm [inches]	0.52
967.5.13	5.0 [0.2]	36 [1.42]	2.5 [0.1]	12.7 [0.5]	10.2 [0.4]	mm [inches]	0.54
967.8.26	8.0 [0.31]	36 [1.42]	2.5 [0.1]	25.4 [1.0]	22.5 [0.89]	mm [inches]	0.93
967.13.38	13.0 [0.51]	36 [1.42]	2.5 [0.1]	38.5 [1.52]	36.0 [1.42]	mm [inches]	2.20
967.15.30	15.0 [0.59]	36 [1.42]	2.5 [0.1]	30.0 [1.18]	22.1 [0.87]	mm [inches]	2.00
967.15.51	15.0 [0.59]	36 [1.42]	2.5 [0.1]	50.8 [2.0]	48.3 [1.9]	mm [inches]	3.42
967.25.90	25.4 [1.0]	36 [1.42]	2.5 [0.1]	88.9 [3.54]	85.6 [3.37]	mm [inches]	10.00

Contact PIN radial - C2: 9 [0.35]

SAMPLE ORDER					
HPR 967.3.38 Type	A Connections	B Cover	100M Resistance value	1 % Tolerance	TC25 Temperature coefficient
	A = axial	G = glass	R = Ω	0.5 %	15 ppm/°C
	R = radial	B = operation in air	K = KΩ	1.0 %	25 ppm/°C
	P = PIN	D = operation in oil	M = MΩ	2.0 %	50 ppm/°C
		U = encasing	G = GΩ	5.0 %	100 ppm/°C
				10.0 %	
				20.0 %	

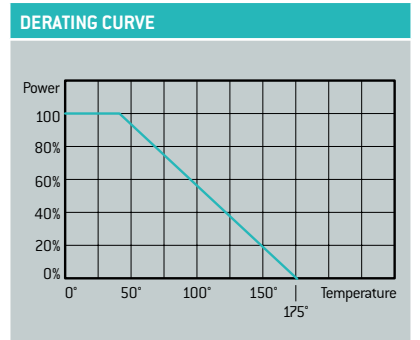

# HIGH VOLTAGE PRECISION RESISTORS HPR 968



These high voltage precision resistors are in a league of their own when it comes to mastering the demanding measuring tasks involved in switching and regulating processes. The high long-term stability makes this type series particularly well-suited for applications in industrial and medical X-ray technology as well as for all test processes.

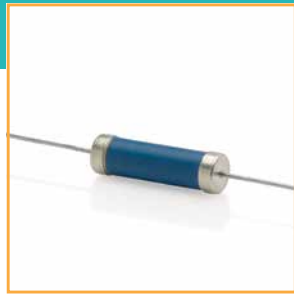

- Outstanding stability
- Very low inductance
- Minimal drift

GENERAL TECHNICAL SPECIFICATIONS	
<b>Tolerance</b>	0.1 % to 20 %*
<b>Temperature coefficient</b>	15 ppm/°C to 200 ppm/°C*
<b>Voltage coefficient</b>	0.08 ppm/V to 0.75 ppm/V (depending on size and layout)
Product drawing and dimensions, refer to pages 6/7. General technical specifications, refer also to type series HVR 968.	
* Other values upon request.	

SAMPLE ORDERS					
HPR 968.5 Type	A Connections	B Cover	100M Resistance value	0.1 % Tolerance	TC25 Temperature coefficient
	A = wire, axial	G = glass	R = Ω	0.1 %	15 ppm/°C
	C = caps	B = operation in air	K = KΩ	0.25 %	25 ppm/°C
		D = operation in oil	M = MΩ	0.5 %	50 ppm/°C
		U = encasing	G = GΩ	1.0 %	100 ppm/°C
				2.0 %	200 ppm/°C
				5.0 %	
				10.0 %	
				20.0 %	

TYPE SELECTION									
TYPES	TCR (ppm/°C)	TOLERANCE							
		0.1 %	0.25 %	0.50 %	1 %	2 %	5 %	10 %	20 %
<b>968.2</b> 2.6 W 9 kV [air] 15 kV [oil]	15/25	60 K – 500 M	60 K – 500 M	60 K – 500 M	60 K – 500 M	60 K – 500 M	60 K – 500 M	60 K – 500 M	60 K – 500 M
	50	15 K – 1 G	15 K – 1 G	15 K – 1 G	15 K – 1 G	15 K – 1 G	15 K – 1 G	15 K – 1 G	15 K – 1 G
	100	15 K – 1 G	15 K – 1 G	15 K – 1 G	15 K – 1 G	15 K – 1 G	15 K – 1 G	15 K – 1 G	15 K – 1 G
	200	15 K – 10 G	15 K – 10 G	15 K – 10 G	15 K – 10 G	15 K – 10 G	15 K – 10 G	15 K – 10 G	15 K – 10 G
<b>968.3</b> 3.0 W 12 kV [air] 22 kV [oil]	15/25	80 K – 750 M	80 K – 750 M	80 K – 750 M	80 K – 750 M	80 K – 750 M	80 K – 750 M	80 K – 750 M	80 K – 750 M
	50	25 K – 1.5 G	25 K – 1.5 G	25 K – 1.5 G	25 K – 1.5 G	25 K – 1.5 G	25 K – 1.5 G	25 K – 1.5 G	25 K – 1.5 G
	100	25 K – 1.5 G	25 K – 1.5 G	25 K – 1.5 G	25 K – 1.5 G	25 K – 1.5 G	25 K – 1.5 G	25 K – 1.5 G	25 K – 1.5 G
	200	25 K – 15 G	25 K – 15 G	25 K – 15 G	25 K – 15 G	25 K – 15 G	25 K – 15 G	25 K – 15 G	25 K – 15 G
<b>968.5</b> 5.0 W 18 kV [air] 30 kV [oil]	15/25	120 K – 1 G	120 K – 1 G	120 K – 1 G	120 K – 1 G	120 K – 1 G	120 K – 1 G	120 K – 1 G	120 K – 1 G
	50	40 K – 2 G	40 K – 2 G	40 K – 2 G	40 K – 2 G	40 K – 2 G	40 K – 2 G	40 K – 2 G	40 K – 2 G
	100	40 K – 2 G	40 K – 2 G	40 K – 2 G	40 K – 2 G	40 K – 2 G	40 K – 2 G	40 K – 2 G	40 K – 2 G
	200	40 K – 20 G	40 K – 20 G	40 K – 20 G	40 K – 20 G	40 K – 20 G	40 K – 20 G	40 K – 20 G	40 K – 20 G
<b>968.7</b> 6.5 W 24 kV [air] 48 kV [oil]	15/25	180 K – 1.5 G	180 K – 1.5 G	180 K – 1.5 G	180 K – 1.5 G	180 K – 1.5 G	180 K – 1.5 G	180 K – 1.5 G	180 K – 1.5 G
	50	45 K – 3 G	45 K – 3 G	45 K – 3 G	45 K – 3 G	45 K – 3 G	45 K – 3 G	45 K – 3 G	45 K – 3 G
	100	45 K – 3 G	45 K – 3 G	45 K – 3 G	45 K – 3 G	45 K – 3 G	45 K – 3 G	45 K – 3 G	45 K – 3 G
	200	45 K – 30 G	45 K – 30 G	45 K – 30 G	45 K – 30 G	45 K – 30 G	45 K – 30 G	45 K – 30 G	45 K – 30 G
<b>968.10</b> 8.0 W 36 kV [air] 54 kV [oil]	15/25	240 K – 2 G	240 K – 2 G	240 K – 2 G	240 K – 2 G	240 K – 2 G	240 K – 2 G	240 K – 2 G	240 K – 2 G
	50	60 K – 3 G	60 K – 3 G	60 K – 3 G	60 K – 3 G	60 K – 3 G	60 K – 3 G	60 K – 3 G	60 K – 3 G
	100	60 K – 3 G	60 K – 3 G	60 K – 3 G	60 K – 3 G	60 K – 3 G	60 K – 3 G	60 K – 3 G	60 K – 3 G
	200	60 K – 30 G	60 K – 30 G	60 K – 30 G	60 K – 30 G	60 K – 30 G	60 K – 30 G	60 K – 30 G	60 K – 30 G
<b>968.12</b> 10.0 W 42 kV [air] 63 kV [oil]	15/25	300 K – 2 G	300 K – 2 G	300 K – 2 G	300 K – 2 G	300 K – 2 G	300 K – 2 G	300 K – 2 G	300 K – 2 G
	50	75 K – 3 G	75 K – 3 G	75 K – 3 G	75 K – 3 G	75 K – 3 G	75 K – 3 G	75 K – 3 G	75 K – 3 G
	100	75 K – 5 G	75 K – 5 G	75 K – 5 G	75 K – 5 G	75 K – 5 G	75 K – 5 G	75 K – 5 G	75 K – 5 G
	200	75 K – 30 G	75 K – 30 G	75 K – 30 G	75 K – 30 G	75 K – 30 G	75 K – 30 G	75 K – 30 G	75 K – 30 G
<b>968.15</b> 12.0 W 54 kV [air] 81 kV [oil]	15/25	350 K – 2 G	350 K – 2 G	350 K – 2 G	350 K – 2 G	350 K – 2 G	350 K – 2 G	350 K – 2 G	350 K – 2 G
	50	85 K – 3 G	85 K – 3 G	85 K – 3 G	85 K – 3 G	85 K – 3 G	85 K – 3 G	85 K – 3 G	85 K – 3 G
	100	85 K – 6 G	85 K – 6 G	85 K – 6 G	85 K – 6 G	85 K – 6 G	85 K – 6 G	85 K – 6 G	85 K – 6 G
	200	85 K – 30 G	85 K – 30 G	85 K – 30 G	85 K – 30 G	85 K – 30 G	85 K – 30 G	85 K – 30 G	85 K – 30 G

Depending on ambient conditions, the characteristics of resistors can change. We recommend a suitability test under operational conditions.

Other resistance values and temperature coefficients upon request.

# HIGH VOLTAGE PRECISION RESISTORS HPR 969



This series of high voltage precision resistors was developed to simultaneously handle high voltages while providing excellent stability. The reliability and precision in recording measurement values are just two of the outstanding features of this type series. At the same time, the resistors also offer high load capacity, making them particularly well-suited for applications in energy transmission, electrostatics and as protective resistors in electric drives.

- High load capacity
- Good stability
- Very low inductance



SAMPLE ORDERS				
HPR 969.54 Type	B Cover	100M Resistance value	0.1 % Tolerance	TC25 Temperature coefficient
	G = glass	R = Ω	0.1 %	15 ppm/°C
	B = operation in air	K = KΩ	0.25 %	25 ppm/°C
	D = operation in oil	M = MΩ	0.5 %	50 ppm/°C
	U = encasing	G = GΩ	1.0 %	100 ppm/°C
			2.0 %	200 ppm/°C
			5.0 %	
			10.0 %	
			20.0 %	

GENERAL TECHNICAL SPECIFICATIONS	
<b>Tolerance</b>	0.1 % to 20 %*
<b>Temperature coefficient</b>	15 ppm/°C to 200 ppm/°C*
<b>Voltage coefficient</b>	0.08 ppm/V to 0.75 ppm/V (depending on size and layout)
Product drawing and dimensions, refer to pages 8/9. General technical specifications, refer also to type series HVR 969.	
* Other values upon request.	

TYPE SELECTION									
TYPES	TCR (ppm/°C)	0.1 %	0.25 %	0.50 %	1 %	2 %	5 %	10 %	20 %
<b>969.11</b>	15/25	50 K – 500 M	50 K – 500 M	50 K – 500 M	50 K – 500 M	50 K – 500 M	50 K – 500 M	50 K – 500 M	50 K – 500 M
11 W	50	20 K – 1 G	20 K – 1 G	20 K – 1 G	20 K – 1 G	20 K – 1 G	20 K – 1 G	20 K – 1 G	20 K – 1 G
24 kV [air]	100	20 K – 1 G	20 K – 1 G	20 K – 1 G	20 K – 1 G	20 K – 1 G	20 K – 1 G	20 K – 1 G	20 K – 1 G
32 kV [oil]	200	20 K – 5 G	20 K – 5 G	20 K – 5 G	20 K – 5 G	20 K – 5 G	20 K – 5 G	20 K – 5 G	20 K – 5 G
<b>969.23</b>	15/25	100 K – 1 G	100 K – 1 G	100 K – 1 G	100 K – 1 G	100 K – 1 G	100 K – 1 G	100 K – 1 G	100 K – 1 G
23 W	50	50 K – 1 G	50 K – 1 G	50 K – 1 G	50 K – 1 G	50 K – 1 G	50 K – 1 G	50 K – 1 G	50 K – 1 G
48 kV [air]	100	50 K – 1 G	50 K – 1 G	50 K – 1 G	50 K – 1 G	50 K – 1 G	50 K – 1 G	50 K – 1 G	50 K – 1 G
72 kV [oil]	200	50 K – 10 G	50 K – 10 G	50 K – 10 G	50 K – 10 G	50 K – 10 G	50 K – 10 G	50 K – 10 G	50 K – 10 G
<b>969.54</b>	15/25	100 K – 1 G	100 K – 1 G	100 K – 1 G	100 K – 1 G	100 K – 1 G	100 K – 1 G	100 K – 1 G	100 K – 1 G
54 W	50	74 K – 1 G	74 K – 1 G	74 K – 1 G	74 K – 1 G	74 K – 1 G	74 K – 1 G	74 K – 1 G	74 K – 1 G
48 kV [air]	100	74 K – 1 G	74 K – 1 G	74 K – 1 G	74 K – 1 G	74 K – 1 G	74 K – 1 G	74 K – 1 G	74 K – 1 G
72 kV [oil]	200	74 K – 10 G	74 K – 10 G	74 K – 10 G	74 K – 10 G	74 K – 10 G	74 K – 10 G	74 K – 10 G	74 K – 10 G
<b>969.71</b>	15/25	100 K – 1.5 G	100 K – 1.5 G	100 K – 1.5 G	100 K – 1.5 G	100 K – 1.5 G	100 K – 1.5 G	100 K – 1.5 G	100 K – 1.5 G
71 W	50	150 K – 1.5 G	150 K – 1.5 G	150 K – 1.5 G	150 K – 1.5 G	150 K – 1.5 G	150 K – 1.5 G	150 K – 1.5 G	150 K – 1.5 G
64 kV [air]	100	150 K – 1.5 G	150 K – 1.5 G	150 K – 1.5 G	150 K – 1.5 G	150 K – 1.5 G	150 K – 1.5 G	150 K – 1.5 G	150 K – 1.5 G
96 kV [oil]	200	150 K – 15 G	150 K – 15 G	150 K – 15 G	150 K – 15 G	150 K – 15 G	150 K – 15 G	150 K – 15 G	150 K – 15 G
<b>969.105</b>	15/25	100 K – 2 G	100 K – 2 G	100 K – 2 G	100 K – 2 G	100 K – 2 G	100 K – 2 G	100 K – 2 G	100 K – 2 G
105 W	50	200 K – 2 G	200 K – 2 G	200 K – 2 G	200 K – 2 G	200 K – 2 G	200 K – 2 G	200 K – 2 G	200 K – 2 G
96 kV [air]	100	200 K – 2 G	200 K – 2 G	200 K – 2 G	200 K – 2 G	200 K – 2 G	200 K – 2 G	200 K – 2 G	200 K – 2 G
148 kV [oil]	200	200 K – 25 G	200 K – 25 G	200 K – 25 G	200 K – 25 G	200 K – 25 G	200 K – 25 G	200 K – 25 G	200 K – 25 G

Other resistance values and temperature coefficients upon request.

# HIGH VOLTAGE PULSE RESISTORS HVI 967 / 968 / 969



The generously-dimensioned design of the high voltage pulse resistors promotes energy distribution, providing an ideal solution for pulse applications. Whether for single pulses or pulse sequences – for all applications in high voltage engineering, high voltage protection systems and high voltage network components HVI pulse resistors are the right choice.



- Flat designs
- High pulse stability
- Very low inductance

Technical drawing and specifications:  
refer to type series HVR 967, HVR 968 and HVR 969.

## GENERAL TECHNICAL SPECIFICATIONS

<b>Tolerance</b>	from 5 %*
<b>Temperature coefficient</b>	100 ppm/°C*
<b>Insulation resistance</b>	>10,000 MΩ (500 V 25 °C 75 % relative humidity)
<b>Dielectric strength of the insulation</b>	>1,000 V (25 °C 75 % relative humidity) ΔR/R 0.25 % max.
<b>Thermal shock</b>	ΔR/R 0.25 % max.
<b>Overload capacity</b>	1.5 x P[nom], 5s (not 1.5 x V[max])
<b>Moisture resistance</b>	ΔR/R 0.25 % max.
<b>Long-term stability</b>	ΔR/R 0.25 % max.
<b>Temperature range (operation / storage)</b>	–55 °C to +175 °C (–55 °C to +100 °C)
<b>Cover</b>	Epoxy-based varnishes (glass, silicone-based encasing)
<b>Connection type</b>	Connection wires, tinned Cu, axial or radial, brass caps with inner thread M4 / M8

Depending on ambient conditions, the characteristics of resistors can change.  
We recommend a suitability test under operational conditions.

\* Other values upon request.

TYPE SELECTION HVI 967				
TYPES	TOLERANCE			
	TCR (ppm/°C)	5 %	10 %	20 %
967.5.13 1 W 5 kV (air) 7.5 kV (oil)	100	50 R – 500 k	50 R – 500 k	50 R – 500 k
967.15.51 4.5 W 30 kV (air) 45 kV (oil)	100	50 R – 500 k	50 R – 500 k	50 R – 500 k
967.28.38 7 W 10 kV (air) 15 kV (oil)	100	50 R – 500 k	50 R – 500 k	50 R – 500 k
TYPE SELECTION HVID 967 – PRINTED ON BOTH SIDES				
967.6.9 0.5 W 3 kV (air) 5 kV (oil)	100	50 R – 500 K	50 R – 500 K	50 R – 500 K
	Dimension: 9.0 mm x 5.5 mm			
967.6.11 0.5 W 5 kV (air) 7.5 kV (oil)	100	50 R – 500 K	50 R – 500 K	50 R – 500 K
	Dimension: 11.0 mm x 5.5 mm			
967.6.13 0.8 W 5 kV (air) 7.5 kV (oil)	100	50 R – 500 K	50 R – 500 K	50 R – 500 K
	Dimension: 13.0 mm x 5.5 mm			
967.8.21 1.0 W 10 kV (air) 15 kV (oil)	100	50 R – 500 K	50 R – 500 K	50 R – 500 K
	Dimension: 21.0 mm x 8.0 mm			
967.11.21 1.5 W 10 kV 15 kV (oil)	100	50 R – 500 K	50 R – 500 K	50 R – 500 K
	Dimension: 21.0 mm x 10.5 mm			
967.11.26 2.0 W 10 kV 15 kV (oil)	100	50 R – 500 K	50 R – 500 K	50 R – 500 K
	Dimension: 24.0 mm x 10.5 mm			
Other resistance values and temperature coefficients upon request.				

TYPE SELECTION HVI 968				
TYPES	TOLERANCE			
	TCR (ppm/°C)	5 %	10 %	20 %
968.3 5 W 12 kV (air) 18 kV (oil)	100	50 R – 500 K	50 R – 500 K	50 R – 500 K
968.5 7.5 W 18 kV (air) 27 kV (oil)	100	80 R – 500 K	80 R – 500 K	80 R – 500 K
968.10 12 W 36 kV (air) 54 kV (oil)	100	100 R – 500 K	100 R – 500 K	100 R – 500 K
TYPE SELECTION HVI 969				
969.11 11 W 24 kV (air) 32 kV (oil)	25	50 R – 500 K	50 R – 500 K	50 R – 500 K
	50			
	100			
	200			
969.54 54 W 48 kV (air) 72 kV (oil)	25	50 R – 500 K	50 R – 500 K	50 R – 500 K
	50			
	100			
	200			
969.71 71 W 64 kV (air) 96 kV (oil)	25	50 R – 500 K	50 R – 500 K	50 R – 500 K
	50			
	100			
	200			
969.105 105 W 96 kV (air) 144 kV (oil)	25	50 R – 500 K	50 R – 500 K	50 R – 500 K
	50			
	100			
	200			
Other resistance values and temperature coefficients upon request, cover with glass: Tolerance ±20%				

SAMPLE ORDER					
HVI 967.5.13 Type	A Connections	B Cover	150R Resistance value	10 % Tolerance	TC25 Temperature coefficient
	A = axial	G = glass	R = Ω	5.0 %	50 ppm/°C
	R = radial	B = operation in air	K = KΩ	10.0 %	100 ppm/°C
		D = operation in oil	M = MΩ	20.0 %	200 ppm/°C
		U = encasing			

HVI 968.5 Type	C Connections	B Cover	100M Resistance value	1 % Tolerance	TC25 Temperature coefficient
	A = axial	G = glass	R = Ω	5.0 %	50 ppm/°C
	C = caps	B = operation in air	K = KΩ	10.0 %	100 ppm/°C
		D = operation in oil	M = MΩ	20.0 %	200 ppm/°C
		U = encasing			

HVI 969.23 Type	B Cover	100M Resistance value	1 % Tolerance	TC25 Temperature coefficient
	G = glass	R = Ω	5.0 %	50 ppm/°C
	B = operation in air	K = KΩ	10.0 %	100 ppm/°C
	D = operation in oil	M = MΩ	20.0 %	200 ppm/°C
	U = encasing			

# HIGH VOLTAGE DIVIDERS HVD AND RESISTOR NETWORKS NW

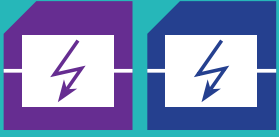

**High voltage dividers** and networks are precision resistors that are ideally suited for precise measuring and dividing of voltages thanks to a multitude of combination possibilities. Metallux high voltage dividers are available as a representative selection of various types. **Networks** are based on special application-oriented requirements. Please contact us – we will be glad to provide consultation.

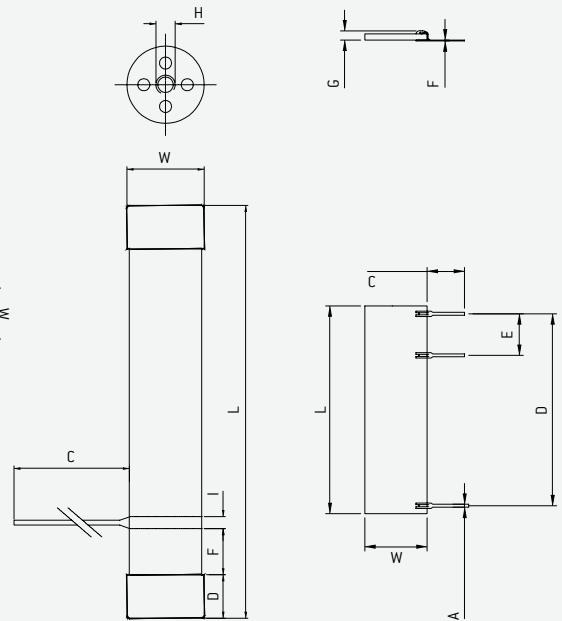
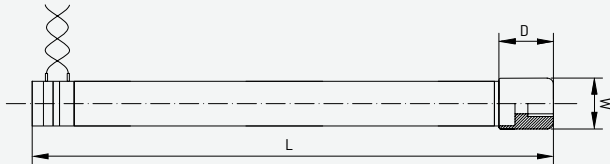
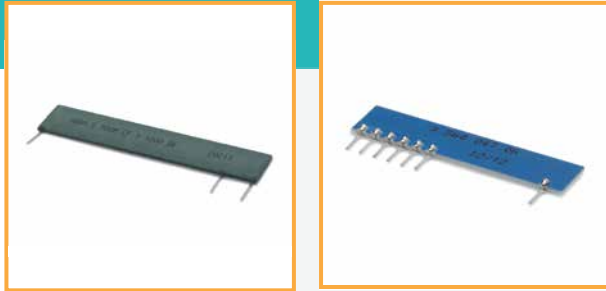

- Very good ratio stability
- Low tolerances
- Minimal drift

## GENERAL TECHNICAL SPECIFICATIONS

<b>Tolerance, absolute</b>	from 0.5 %*
<b>Tolerance, ratio</b>	from 0.1 %*
<b>Temperature coefficient, absolute</b>	from 25 ppm/°C*
<b>Voltage coefficient, ratio</b>	from 15 ppm/°C*
<b>Insulation resistance</b>	>10,000 MΩ (500 V 25 °C 75 % relative humidity)
<b>Dielectric strength of the insulation</b>	>1,000 V (25 °C 75 % relative humidity) ΔR/R 0.25 % max.
<b>Thermal shock</b>	ΔR/R 0.25 % max.
<b>Moisture resistance</b>	ΔR/R 0.25 % max.
<b>Long-term stability</b>	ΔR/R 0.25 % max.
<b>Temperature range (operation / storage)</b>	−55 °C to +175 °C (−55 °C to +100 °C)
<b>Cover</b>	Epoxy-based varnishes (glass, silicone-based encasing)
<b>Connection type</b>	Connection wires Ø 0.8, tinned Cu, axial or radial (optionally Ø 0.5 silvered Cu) Brass caps with inner thread M4 or M8

Depending on ambient conditions, the characteristics of resistors can change. We recommend a suitability test under operational conditions.

\* Other values upon request.



TYPE SELECTION								
TYPES	TOLERANCE RATIO / ABS.*							
	TCR ratio/abs. [ppm/°C]*	Division ratio	0.1 % /from 0.5 %	0.25 % /from 1 %	0.5 % /from 1 %	1 % /from 2 %	2 % /from 5 %	5 % /from 10 %
HVD 967.8.26 <i>(formerly: 1000.2)</i> 0.5 W 8/12 kV (air/oil)	15 / 25	1:500 – 1:1000	1.5 M – 100 K	1.5 M – 100 K	1.5 M – 100 K	1.5 M – 100 K	1.5 M – 100 K	1.5 M – 100 K
	25 / 50	1:500 – 1:2000	1.5 M – 150 K	1.5 M – 150 K	1.5 M – 150 K	1.5 M – 150 K	1.5 M – 150 K	1.5 M – 150 K
	50 / 100	1:500 – 1:2000	1.5 M – 150 K	1.5 M – 150 K	1.5 M – 150 K	1.5 M – 150 K	1.5 M – 150 K	1.5 M – 150 K
	100 / 200	1:500 – 1:2000	1.5 M – 150 K	1.5 M – 150 K	1.5 M – 150 K	1.5 M – 150 K	1.5 M – 150 K	1.5 M – 150 K
967.13.38 <i>(formerly: 1000.3)</i> 1.2 W 15/22 kV (air/oil)	15 / 25	1:500 – 1:5000	5 M – 300 M	5 M – 300 M	5 M – 300 M	5 M – 300 M	5 M – 300 M	5 M – 300 M
	25 / 50	1:500 – 1:10000	5 M – 500 M	5 M – 500 M	5 M – 500 M	5 M – 500 M	5 M – 500 M	5 M – 500 M
	50 / 100	1:500 – 1:10000	5 M – 500 M	5 M – 500 M	5 M – 500 M	5 M – 500 M	5 M – 500 M	5 M – 500 M
	100 / 200	1:500 – 1:10000	5 M – 500 M	5 M – 500 M	5 M – 500 M	5 M – 500 M	5 M – 500 M	5 M – 500 M
967.15.30 1 W 15 kV (air) 22 kV (oil)	15 / 25	1:500 – 1:5000	5 M – 300 M	5 M – 300 M	5 M – 300 M	5 M – 300 M	5 M – 300 M	5 M – 300 M
	25 / 50	1:500 – 1:10000	5 M – 500 M	5 M – 500 M	5 M – 500 M	5 M – 500 M	5 M – 500 M	5 M – 500 M
	50 / 100	1:500 – 1:10000	5 M – 500 M	5 M – 500 M	5 M – 500 M	5 M – 500 M	5 M – 500 M	5 M – 500 M
	100 / 200	1:500 – 1:10000	5 M – 500 M	5 M – 500 M	5 M – 500 M	5 M – 500 M	5 M – 500 M	5 M – 500 M
967.15.51 <i>(formerly: 1000.4)</i> 1.8 W 24/46 kV (air/oil)	15 / 25	1:500 – 1:5000	10 M – 500 M	10 M – 500 M	10 M – 500 M	10 M – 500 M	10 M – 500 M	10 M – 500 M
	25 / 50	1:500 – 1:10000	10 M – 1 G	10 M – 1 G	10 M – 1 G	10 M – 1 G	10 M – 1 G	10 M – 1 G
	50 / 100	1:500 – 1:10000	10 M – 1.5 G	10 M – 1.5 G	10 M – 1.5 G	10 M – 1.5 G	10 M – 1.5 G	10 M – 1.5 G
	100 / 200	1:500 – 1:10000	10 M – 1.5 G	10 M – 1.5 G	10 M – 1.5 G	10 M – 1.5 G	10 M – 1.5 G	10 M – 1.5 G
967.15.77 <i>(formerly: 1000.5)</i> 2.4 W 32/49 kV (air/oil)	15 / 25	1:500 – 1:5000	15 M – 1 G	15 M – 1 G	15 M – 1 G	15 M – 1 G	15 M – 1 G	15 M – 1 G
	25 / 50	1:500 – 1:10000	15 M – 1 G	15 M – 1 G	15 M – 1 G	15 M – 1 G	15 M – 1 G	15 M – 1 G
	50 / 100	1:500 – 1:10000	15 M – 2 G	15 M – 2 G	15 M – 2 G	15 M – 2 G	15 M – 2 G	15 M – 2 G
	100 / 200	1:500 – 1:10000	15 M – 2 G	15 M – 2 G	15 M – 2 G	15 M – 2 G	15 M – 2 G	15 M – 2 G
968.5 3 W 15 kV (air) 22 kV (oil)	15 / 25	1:500 – 1:5000	15 M – 1 G	15 M – 1 G	15 M – 1 G	15 M – 1 G	15 M – 1 G	15 M – 1 G
	25 / 50	1:100 – 1:10000	15 M – 1 G	15 M – 1 G	15 M – 1 G	15 M – 1 G	15 M – 1 G	15 M – 1 G
	50 / 100	1:100 – 1:10000	15 M – 2 G	15 M – 2 G	15 M – 2 G	15 M – 2 G	15 M – 2 G	15 M – 2 G
	100 / 200	1:100 – 1:10000	15 M – 2 G	15 M – 2 G	15 M – 2 G	15 M – 2 G	15 M – 2 G	15 M – 2 G
968.7 6 W 20 kV (air) 30 kV (oil)	15 / 25	1:500 – 1:5000	15 M – 1 G	15 M – 1 G	15 M – 1 G	15 M – 1 G	15 M – 1 G	15 M – 1 G
	25 / 50	1:100 – 1:10000	15 M – 1 G	15 M – 1 G	15 M – 1 G	15 M – 1 G	15 M – 1 G	15 M – 1 G
	50 / 100	1:100 – 1:10000	15 M – 2 G	15 M – 2 G	15 M – 2 G	15 M – 2 G	15 M – 2 G	15 M – 2 G
	100 / 200	1:100 – 1:10000	15 M – 2 G	15 M – 2 G	15 M – 2 G	15 M – 2 G	15 M – 2 G	15 M – 2 G
969.23 <i>(formerly: 2000.23)</i> 10 W 45/60 kV (air/oil)	15 / 25	1:100 – 1:10000	20 M – 500 M	20 M – 500 M	20 M – 500 M	20 M – 500 M	20 M – 500 M	20 M – 500 M
	25 / 50	1:100 – 1:20000	20 M – 2 G	20 M – 2 G	20 M – 2 G	20 M – 2 G	20 M – 2 G	20 M – 2 G
	50 / 100	1:100 – 1:20000	20 M – 3 G	20 M – 3 G	20 M – 3 G	20 M – 3 G	20 M – 3 G	20 M – 3 G
	100 / 200	1:100 – 1:20000	20 M – 3 G	20 M – 3 G	20 M – 3 G	20 M – 3 G	20 M – 3 G	20 M – 3 G
969.105 <i>(formerly: 2000.105)</i> 50 W 90/120 kV (air/oil)	15 / 25	1:100 – 1:10000	20 M – 1 G	20 M – 1 G	20 M – 1 G	20 M – 1 G	20 M – 1 G	20 M – 1 G
	25 / 50	1:100 – 1:20000	20 M – 2 G	20 M – 2 G	20 M – 2 G	20 M – 2 G	20 M – 2 G	20 M – 2 G
	50 / 100	1:100 – 1:20000	20 M – 3 G	20 M – 3 G	20 M – 3 G	20 M – 3 G	20 M – 3 G	20 M – 3 G
	100 / 200	1:100 – 1:20000	20 M – 3 G	20 M – 3 G	20 M – 3 G	20 M – 3 G	20 M – 3 G	20 M – 3 G

\* Other values upon request.

DIMENSIONS									
TYPES	A	W = width	L = length	C	D	E	F	G	Unit
967.8.26	0.6 (0.02)	8.0 (0.31)	25.4 (1.0)	9.1 (0.36)	22.9 (0.9)	5.08 (0.2)	0.3 (0.01)	2.5 (0.1)	mm (inches)
967.13.38	0.6 (0.02)	13.0 (0.51)	38.5 (1.52)	9.1 (0.36)	35.6 (1.4)	7.6 (0.3)	0.3 (0.01)	2.5 (0.1)	mm (inches)
967.15.30	0.8 (0.02)	15.0 (0.59)	30.0 (1.18)	36.0 (1.42)	22.86 (0.9)	5.08 (0.2)		2.5 (0.1)	mm (inches)
967.15.51	0.6 (0.02)	15.0 (0.59)	50.8 (2.0)	9.1 (0.36)	48.3 (1.9)	10.16 (0.4)	0.3 (0.01)	2.5 (0.1)	mm (inches)
967.15.77	0.6 (0.02)	15.5 (0.61)	77.5 (3.05)	9.1 (0.36)	73.4 (2.89)	10.2 (0.4)	0.3 (0.01)	2.5 (0.1)	mm (inches)
TYPES		L = length	B = Ø	C	D	E	H	I	Unit
968.5		52.0 (2.05)	8.0 (0.31)		8.5 (0.35)		M4		mm (inches)
968.7		78.0 (3.07)	8.0 (0.31)		8.5 (0.35)		M4		mm (inches)
969.23		156 (6.14)	13 (0.51)		10 (0.39)	6.5 (0.26)	M6		mm (inches)
969.105		308 (12.13)	30 (1.18)		10 (0.39)	21 (0.83)	M8		mm (inches)

SAMPLE ORDERS							
HVD 967.8.26	D	33M	1:5000	0.25 % / 0.5 %	TC50 / TC100		
HVD 967.7	B	100M	1:1000	1.0 % / 2.0 %	TC25 / 15		
HVD 969.23	U	1G	1:10,000	5.0 % / 10.0 %	TC15 / TC25		
Type	Cover	Resistance value	Division ratio	Tol.abs. / Tol.ratio	TCabs. / TCratio...ppm/°C		
	U = encasing	R = Ω		0.1 %	0.5 %	TC15	TC25
	B = operation in air	K = KΩ		0.25 %	1.0 %	TC25	TC50
	D = operation in oil	M = MΩ		0.5 %	1.0 %	TC50	TC100
	G = glass	G = GΩ		1.0 %	2.0 %	TC100	TC200
				2.0 %	5.0 %		
				5.0 %	10.0 %		
				10.0 %	20.0 %		

# HIGH VOLTAGE SMD RESISTORS HVS 967



As a variant of the reliable HVR967 type series, high voltage SMD resistors present an interesting addition to the classic standard SMD chip resistors.

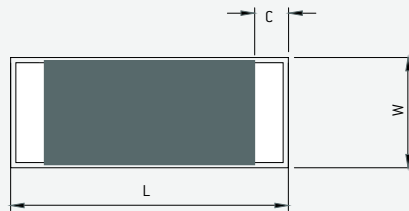

- Pulse-proof
- Low inductance
- SMD assembly



SAMPLE ORDER				
HVS 967.3.38 Type	B Cover	100M Resistance value	1 % Tolerance	TC25 Temperature coefficient
	G = glass	R = Ω	0.5 %	25 ppm/°C
	B = operation in air	K = KΩ	1 %	50 ppm/°C
	D = operation in oil	M = MΩ	2 %	100 ppm/°C
		G = GΩ	5 %	200 ppm/°C
			10 %	
			20 %	

TYPE SELECTION HVS 967							
TYPES	TOLERANCE						
	TCR(ppm/°C)	0.50 %	1 %	2 %	5 %	10 %	20 %
<b>967.3.25</b> 1 W 8 kV [air] 12 kV [oil]	25 / 50 100	5 K – 2 G 5 K – 2 G	2 K – 2 G 2 K – 2 G	2 K – 2 G 2 K – 2 G	2 – 2 G 2 K – 2 G	2 K – 2 G 2 K – 2 G	2 K – 2 G 2 K – 2 G
<b>967.5.13</b> 1 W 5 kV [air] 7.5 kV [oil]	25 / 50 100	4 K – 500 M 4 K – 500 M	4 K – 3 G 4 K – 3 G	4 K – 3 G 4 K – 3 G	4 K – 3 G 4 K – 3 G	4 K – 3 G 4 K – 3 G	4 K – 3 G 4 K – 3 G
<b>967.6.12</b> 1 W 5 kV [air] 7.5 kV [oil]	25 / 50 100	4 K – 500 M 4 K – 500 M	4 K – 3 G 4 K – 3 G	4 K – 3 G 4 K – 3 G	4 K – 3 G 4 K – 3 G	4 K – 3 G 4 K – 3 G	4 K – 3 G 4 K – 3 G
<b>967.6.25</b> 1.5 W 10 kV [air] 15 kV [oil]	25 / 50 100	3 K – 500 M 3 K – 500 M	2 K – 1 G 2 K – 1 G	2 K – 1 G 2 K – 1 G	2 K – 1 G 2 K – 1 G	2 K – 1 G 2 K – 1 G	2 K – 1 G 2 K – 1 G
<b>967.8.26</b> 1.5 W 10 kV [air] 15 kV [oil]	25 / 50 100	3 K – 500 M 3 K – 500 M	2 K – 1 G 2 K – 1 G	2 K – 1 G 2 K – 1 G	2 K – 1 G 2 K – 1 G	2 K – 1 G 2 K – 1 G	2 K – 1 G 2 K – 1 G

Other resistance values and temperature coefficients upon request.

DIMENSIONS					
TYPES	W [width]	C	G	L [length]	Unit
<b>967.3.25</b>	3.8 [0.2]	1.55 [0.06]	0.63 [0.02]	25.4 [1.0]	mm (inches)
<b>967.5.13</b>	5.0 [0.2]	1.55 [0.06]	0.63 [0.02]	12.7 [0.5]	mm (inches)
<b>967.6.12</b>	6.35 [0.25]	1.55 [0.06]	0.63 [0.02]	12.7 [0.5]	mm (inches)
<b>967.6.25</b>	6.35 [0.25]	1.55 [0.06]	0.63 [0.02]	25.4 [1.0]	mm (inches)
<b>967.8.26</b>	8.0 [0.31]	1.55 [0.06]	0.63 [0.02]	25.4 [1.0]	mm (inches)

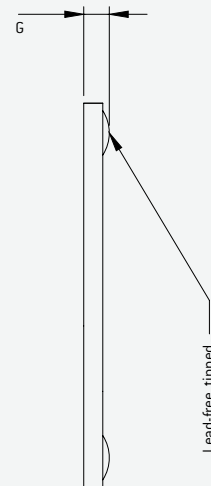

## GENERAL TECHNICAL SPECIFICATIONS

<b>Tolerance</b>	0.5 % to 20 %*
<b>Temperature coefficient</b>	25 ppm/°C to 200 ppm/°C*
<b>Insulation resistance</b>	10,000 MΩ (500 V 25 °C 75 % relative humidity)
<b>Dielectric strength of the insulation</b>	>1,000 V (25 °C 75 % relative humidity) ΔR/R 0.25 % max.
<b>Thermal shock</b>	ΔR/R 0.25 % max.
<b>Temperature range (operation/storage)</b>	–55 °C to +175 °C (–55 °C to +100 °C)
<b>Cover</b>	Epoxy-based varnish
<b>Connection type</b>	Solder pads, tinned

Depending on ambient conditions, the characteristics of resistors can change. We recommend a suitability test under operational conditions.

\* Other values upon request.

# HIGH VOLTAGE POTENTIOMETERS POC 400



The POC 400 high voltage potentiometer is based on a ceramic substrate, embedded in plastic encasing with excellent insulating properties. Carefully selected high-quality materials, paired with decades of experience in the development and production of linear and rotary sensors, are the guarantee for a long service life without any function loss.

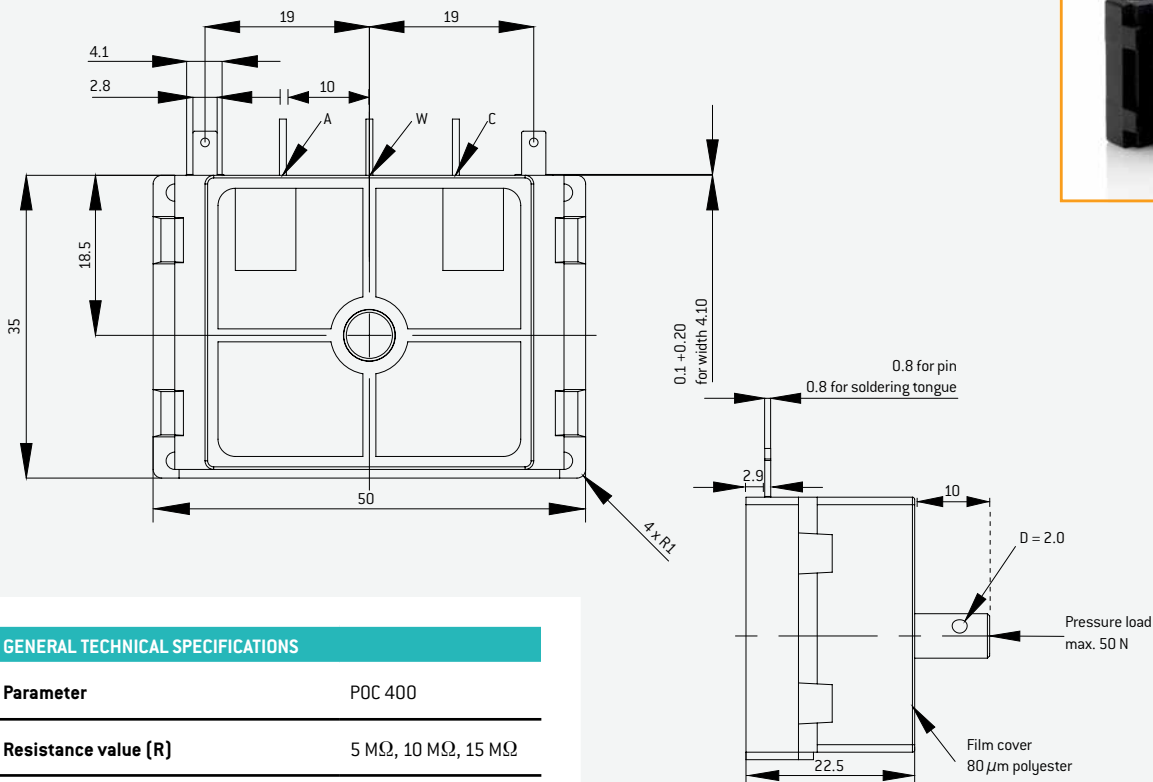

## GENERAL TECHNICAL SPECIFICATIONS

Parameter	POC 400
Resistance value (R)	5 MΩ, 10 MΩ, 15 MΩ
Tolerance	± 10 %
Linearity	± 4 %
Max. operational voltage (V)	2.5 kV
Insulation voltage	>2.5 kV
Temperature coefficient absolute (TCabs.)	50 ppm/K
Temperature coefficient ratio (TCratio)	50 ppm/K @R = 1:1
Temperature range	-20 °C to +70 °C
Contact resistance (Rc)	<15 KΩ at 15 MΩ
Rotary angle	305 ± 5°
Degree of protection	IP 60

Depending on ambient conditions, the characteristics of resistors can change. We recommend a suitability test under operational conditions.

\* Other values upon request.

- Adjustable high voltage up to 2.5 kV
- Suitable for implementation in high voltage measurement and power units, spectrometers, electrical precipitators and much more.
- Simple contacting and mounting

## SAMPLE ORDERS

POC 400 Type	100 M Resistance value
--------------	------------------------

## NOTES ON APPLICATION

For safety reasons related to dielectric strength under high voltage, the following connector pin assignment should be observed:

PIN A: Voltage in+

PIN B: Out 5 – 95 %

PIN C: Gnd or voltage in –

# POWER RESISTORS PLR 100, 200, 300, 900



The space-saving design of power resistors made using thick-film technology on steel substrates makes it possible to achieve high capacity, even in the narrowest spaces. Special features including extremely low inductance and high resistance values open new perspectives in power electronics. Variable resistance values, in addition to standard dimensions, freely selectable geometries upon request, as well as universal connection variants, optimally round out the product family of Metallux power resistors.

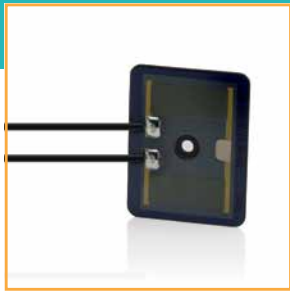

**Standard types:**

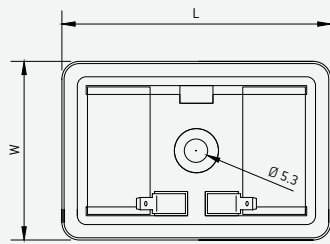

PLR100.61.41

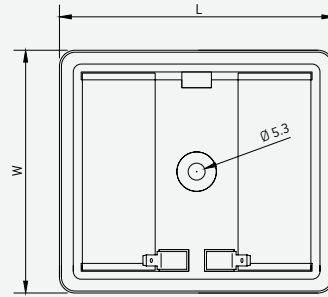

PLR100.70.61

**Optional types:**

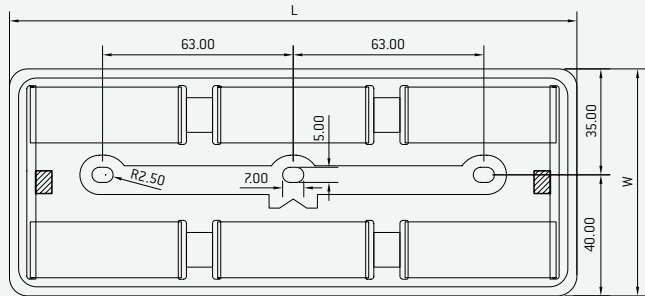
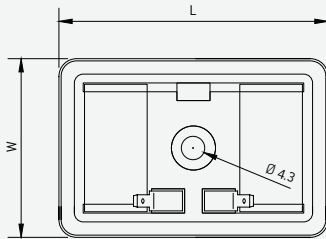

PLR 900.188.75

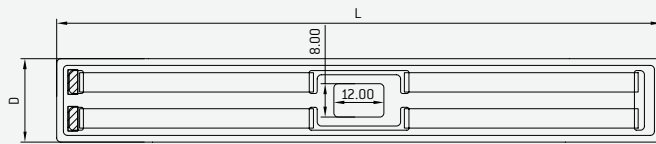

PLR 200.145.20

- Pulse-proof
- Low inductive
- Simple mounting

**Connection variants:**

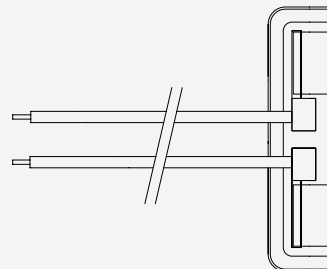
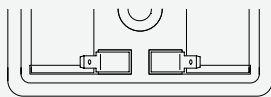

**Plug-in terminals**

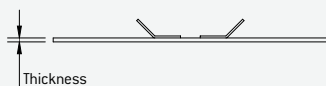

**Connection wires**

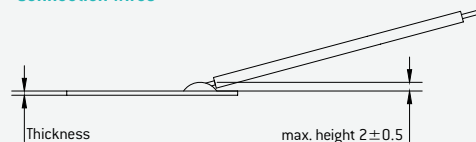

GENERAL TECHNICAL SPECIFICATIONS	
Resistance values, standard	[E12] 10 Ω, 22 Ω, 47 Ω, 68 Ω, 100 Ω, 220 Ω, 470 Ω, 680 Ω*
Tolerance	≥ ± 10 %*
Temperature coefficient	150 ppm/°C
Max. operational voltage	1,000 VDC
Dielectric strength of the insulation	2.5 KVDC, 60 s @ 50 Hz
Stability (max. ΔR/R)	± 20 %
Inductance	< 6 μH
Temperature range (operation / storage)	− 50 °C to +200 °C / − 40 °C to +105 °C
Tightening torque (fastening screws)	3 Nm
Cover*	Glass
Protection rating	IP00
Connection type	Wires, solder lug, plug-in terminals

Depending on ambient conditions, the characteristics of resistors can change.  
We recommend a suitability test under operational conditions.

\* Other values upon request.

TYPES				
	Nominal power	Resistance values [Ω]	Attachment	Weight [g]
Standard types				
100.61.41	100	5 – 500	M5	20
300.70.61	300	5 – 500	M5	34
Optional types				
100.55.43	100	5 – 500	M4	19
200.145.20	200	5 – 500	without	23
900.188.75	900	5 – 500	3xM5	110

DIMENSIONS				
	Length	Width	Thickness	Unit
Standard types				
100.61.41	61.0 [2.40]	41.0 [1.61]	1.0 [0.04]	mm (inches)
300.70.61	70.0 [2.76]	61.0 [2.40]	1.0 [0.04]	mm (inches)
Optional types				
100.55.43	55.0 [2.17]	43.0 [1.69]	1.0 [0.04]	mm (inches)
200.145.20	145.0 [5.71]	20.0 [0.79]	1.0 [0.04]	mm (inches)
900.188.75	188.0 [7.40]	75.0 [2.95]	1.0 [0.04]	mm (inches)

SAMPLE ORDERS			
Type	Resistance value	Tolerance	Connection variants
PLR 100.61.41	100 R	10 %	
			K = 100 mm wires, PVC, UL1015, AWG20, blk
			L = solder terminal
			S = Plug-in terminal

# NEW BY METALLUX: POWER AND PULSE RESISTORS



The type series PLR-T0 with three additional performance classes will augment the established Metallux range of performance film resistors. The familiar design with new material pairings offers even more capacity and dielectric strength in the narrowest spaces.

In the new type series PCR particularly low impedance high voltage pulse resistors are available. The resistance value and pulse energy from three different diameters and variable lengths can be combined.

### POWER RESISTORS OF THE TYPE SERIES T0

Model	Max. operational voltage	Power without cooling	Power with cooling	Resistance values	Tolerance
T0-126	300V	2W	30W	1R0 – 10K	5%, 10%
T0-220	300V	3.5W	60W	1R0 – 10K	5%, 10%
T0-247	300V	6W	120W	1R0 – 10K	5%, 10%

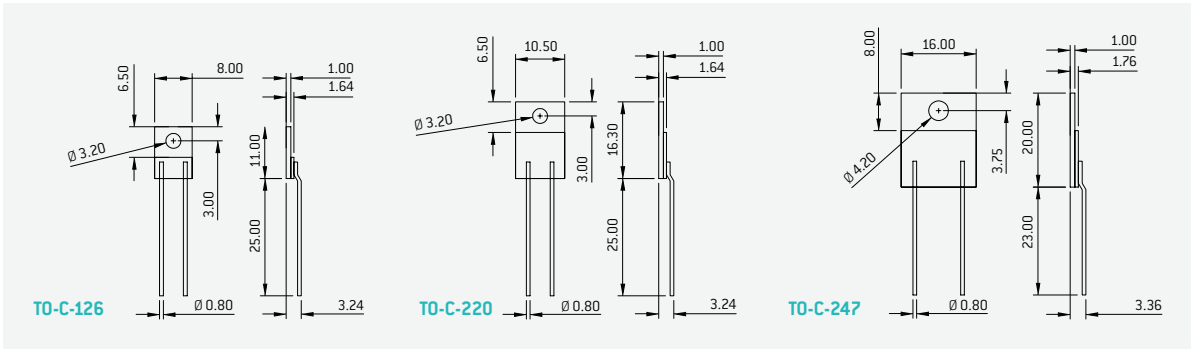

### PULSE RESISTORS OF THE TYPE SERIES PCR

Model	Nominal power at $\Delta T = 400K$	Resistance values	Max. permitted voltage, operation in air	Pulse energy [1s at $\Delta T 200K$ ]
PCR 8	1 – 5W	0R3 to 1R	10kV	3 KJ
PCR 13	5 – 50W	0R3 to 1R5	35kV	5 KJ
PCR 30	50 – 200W	0R3 to 0R5	60kV	35 KJ

Model	L [mm]	$\varnothing$ [mm]	M
PCR 8	to 120	8.5	M4
PCR 13	to 220	14.5	M4
PCR 30	to 230	31.8	M5

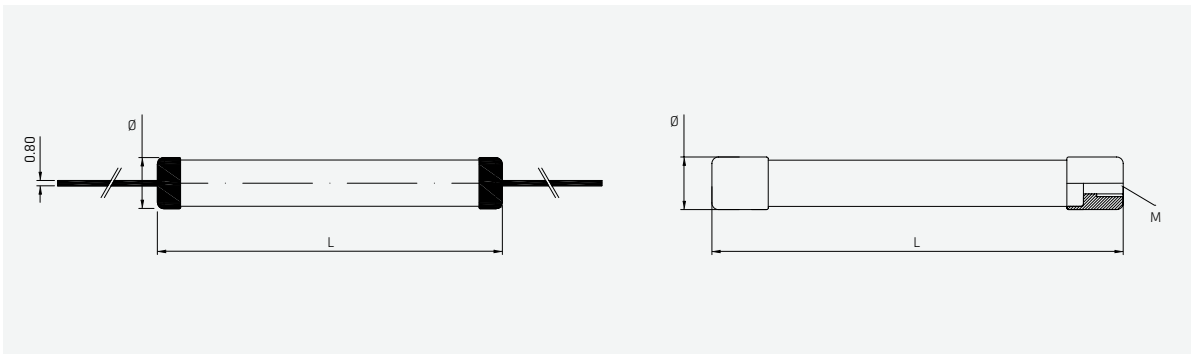

# APPLICATIONS



The variety of the Metallux thick-film resistors makes it possible to use these components in many applications. The spectrum ranges from highly accurate precision resistors with long term stability to types with an extremely high pulse load capacity.



High voltage cascades in transducers for HVDC (high voltage direct current transmission) systems

Voltage sensors for monitoring and stabilising power supplies



High voltage resistors as sensors for stable, high-precision imaging in medical and industrial X-ray systems



Power and high voltage resistors in cable, measurement and testing technology for detecting and locating insulation errors; testing insulation materials and defining fuses in circuits



Charging and discharging resistors for capacitors



Electrostatic paint finishing system

[www.metallux-usa.com](http://www.metallux-usa.com)

© [www.metallux-usa.com](http://www.metallux-usa.com) 01/2016



**METALLUX USA, INC.**

2340 Brighton Henrietta  
Town Line Road, Suite 4  
Rochester, NY 14623  
USA

PHONE +1 (585)360 - 0054  
FAX +1 (866)429 - 0360  
E-mail: [info@metallux-usa.com](mailto:info@metallux-usa.com)