

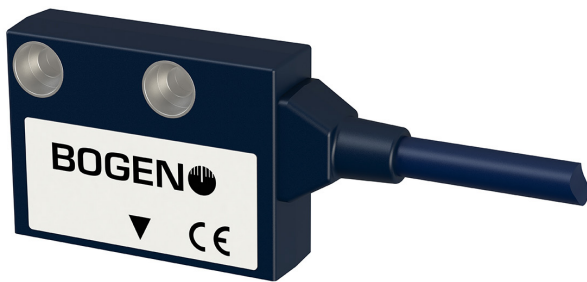

Measuring



Positioning



IKS8 Incremental Magnetic Sensing Head

- Linear applications
- Rotary applications
- Non contact, quick position measurement

Features

- Precise
- Programmable with PC or App
- Single piece unit
- Programmable resolutions
- Customisable output frequencies
- A variety of connectors with adaptable cable lengths
- No wear from usage
- High measuring distance tolerance
- Resistant to dust, cooling lubricant emulsion, oil, etc.
- Unlimited measuring length

Measuring movements with the IKS8 – simple – precise – economic

The incremental magnetic sensing head IKS8 for linear and rotary applications impresses customers with an extremely high accuracy and a particularly high degree of modularity. BOGEN offers different variants of the IKS8 that can be configured to customer-specific requirements. In combination with an individual scale, measurement solutions for almost every application can be custom-tailored.

Features

Resolution	61 nm to 625 μm, depending on the pole length
Max. Movement Speed	up to 75 m/s, depending on the pole length and resolution
Energy consumption (without Load)	<65 mA (UB = 5 V)
Operating temperature	-20 to +70 °C
Storage temperature	-20 to +80 °C
Protection class	IP67
LED	Error displayed when distance or speed too high
Adjustable parameters	Resolution, maximum output frequency and counting (with optional programming device and the appropriate software)
Weight	

Resolution and Speed

Default Values at Output Frequency F = 1000 kHz

Pole Pitch <i>P</i> [mm]	Resolution <i>R</i> [μm]	Max. Movement Speed <i>V_{max}</i> [m/s]
0.5	0.25	1
1	0.5	2
2	1	4
2.54	1.27	5.08
5	2.5	10

Complete range of adjustable resolutions after evaluation of four edges can be calculated as follows:

$$[\text{Resolution (mm)}] = [\text{Pole Pitch (mm)}] / [\text{Resolution Factor}]$$

Existing resolution factors:

8, 16, 25, 32, 40, 50, 64, 80, 100, 125, 128, 160, 200, 250, 256, 320, 400, 500, 512, 800, 1000, 1024, 1600, 2000, 2048, 4096, 8192

Sensing Head Variants

Pole pitch	0.5 mm; 1 mm; 2 mm; 2.54mm; 5 mm
Reference	Reference chip for 2nd track (except for 0.5 mm pole pitch) or periodically from the pole pitch
Voltage	V5 = 5 V ± 5 % V24 = 7 - 32 V
Interface (without load)	D1 = RS422 (0 to 5 V) D2 = Push-Pull HTL (0 to supply voltage) D3 = Push-Pull TTL (0 to 5 V)
Cable length of sensing head	Standard 2 m, optional variable length from 10 cm up to 6 m
Connector	open cable end, optional plug according to order code, other specifications on request

Output Circuit

RS422

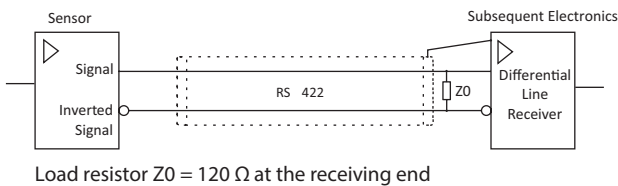

Push-Pull (HTL, TTL)

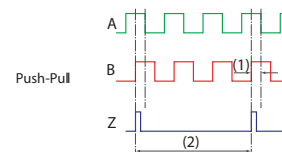
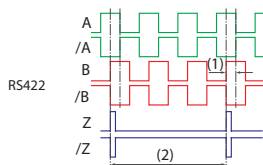
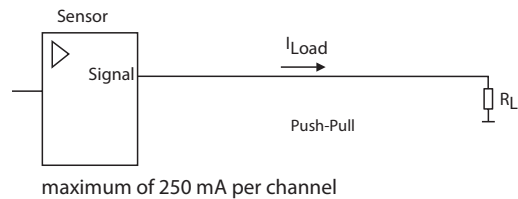

Output Signals

Signals	A, /A, B, /B, Z, /Z
---------	---------------------

- (1) Phase shift A and B 90° ±10° electrical
- (2) Signal period depending on the reference track pattern or as a periodic reference depending on the pole pitch
- Z Length default is 1 count

To avoid EMI please connect housing to protective earthing!

Dimensions

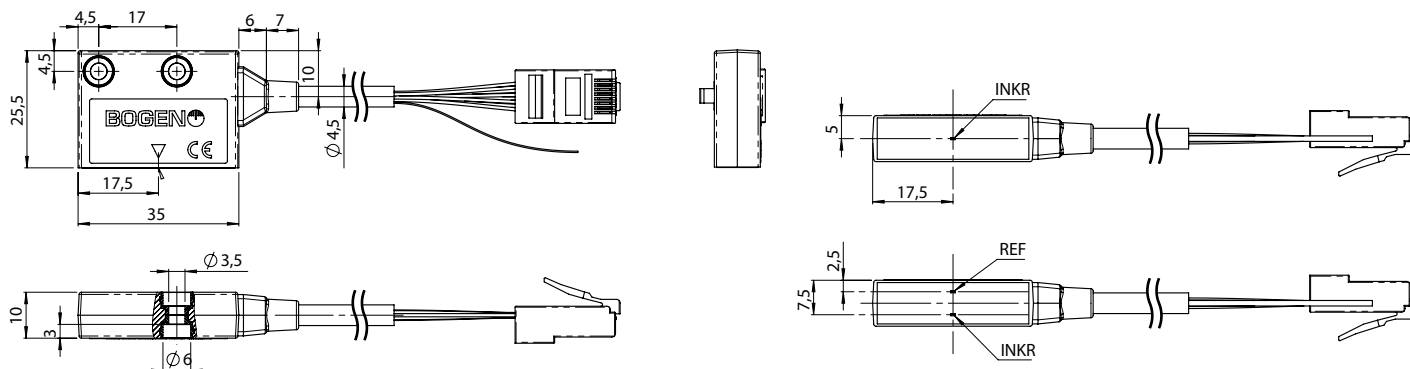

Installation Tolerances

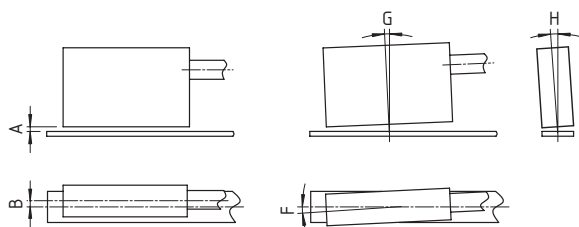

	Pole Pitch 0.5 mm	Pole Pitch 1 mm	Pole Pitch 2 mm	Pole Pitch 2.54 mm	Pole Pitch 5 mm
A [mm]	0.1 to 0.25	0.1 to 0.5	0.1 to 1.0	0.1 to 1.27	0.1 to 2.5
B ⁽³⁾ [mm]	2.5	2.5	2.5	2.5	2.5
B ⁽⁴⁾ [mm]	0.5	0.5	0.5	0.5	0.5
G	0.5°	1°	1°	1°	1°
H	1°	3°	3°	3°	3°
F	3°	3°	3°	3°	3°

⁽³⁾ relative to 10 mm scale width (1-track)

⁽⁴⁾ relative to 10 mm scale width (2-track)

Pin Assignment

Signal ⁽⁵⁾	Color	Pin No.					
		C1 RJ45 (8P8C)	C2 M12 plug (male)	C3 D-SUB 9 (male)	C4 D-SUB 15 (male)	C5 D-SUB 25 (female)	C6 D-SUB 15 HD (male)
V-	blue	1	1	9	2	2 + 16 ⁽⁶⁾	2
V+	red	2	2	5	7	1 + 14 ⁽⁶⁾	7
A	brown	3	3	4	14	3	14
/A	green	4	4	8	6	4	6
B	gray	5	5	3	13	6	13
/B	yellow	6	6	7	5	7	5
Z	pink	7	7	2	12	17	12
/Z	white	8	8	6	4	18	4
Shield	-	-	1	Case	Case	Case	Case + 15

(5) PIN 1 with Pin 14 and Pin 2 with Pin 16 connected through solder bridge

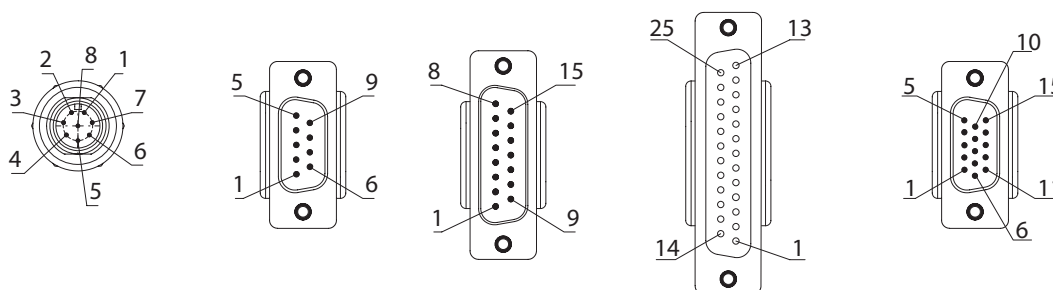

C1: RJ45 (8P8C) C2: M12 plug, (male) C3: D-SUB 9 (male) C4: D-SUB 15 (male) C5: D-SUB 25 (female) C6: D-SUB 15 HD (male)

Optional Accessory – Order Codes for Linear Scales, 10 mm Width⁽⁶⁾

Pole Pitch	Accuracy A3	Accuracy A10	Accuracy A20	Accuracy A40 (standard)
0.5	LMSI-W10P0.5L...A3K	LMSI-W10P0.5L...A10K	LMSI-W10P0.5L...A20K	LMSI-W10P0.5L...A40K
1	LMSI-W10P1L...A3K	LMSI-W10P1L...A10K	LMSI-W10P1L...A20K	LMSI-W10P1L...A40K
2	LMSI-W10P2L...A3K	LMSI-W10P2L...A10K	LMSI-W10P2L...A20K	LMSI-W10P2L...A40K
2.54	LMSI-W10P2.54L...A3K	LMSI-W10P2.54L...A10K	LMSI-W10P2.54L...A20K	LMSI-W10P2.54L...A40K
5	LMSI-W10P5L...A3K	LMSI-W10P5L...A10K	LMSI-W10P5L...A20K	LMSI-W10P5L...A40K

⁽⁶⁾ Scale dimensions: 10 mm x 1.3 mm (w/o cover tape), length up to 50 m. Other accuracies, other pole pitches, other scale widths and scales with reference track on request. See separate data sheet for linear scales for further possibilities and deliverable length (L...).

Optional Accessory – Rotary Scales

See separate data sheet for rotary scales for further possibilities.

Order Code

Parameter

IKS8 - Z P V D R F T L C

		Code ⁽⁷⁾	Explanation ⁽⁷⁾
Z	Reference Signal	Z1	periodic index signal from the pole pitch (standard)
		Z2	from reference marks (requires 2-track magnetic tape with incremental track and reference track)
P	Pole Pitch [mm]	P0.5	0.5 mm (not interoperable with Z2)
		P1	1 mm
		P2	2 mm
		P2.54	2.54 mm
		P5	5 mm
V	Supply Voltage [V]	V5	5 V
		V24	7...32 V
D	Interface	D1	RS422
		D2	Push-Pull HTL
		D3	Push-Pull TTL
R	Resolution ⁽⁹⁾ [µm]	R0.25	Standard for pole pitch 0.5 mm
		R0.5	Standard for pole pitch 1 mm
		R1	Standard for pole pitch 2 mm
		R1.27	Standard for pole pitch 2.54 mm
		R2.5	Standard for pole pitch 5 mm
		R...	Other non-standard resolutions, see section "Resolution and Speed" page 2
F	Maximum Output Frequency [kHz]	F3500	3500 kHz
		F1500	1500 kHz
		F1000	1000 kHz
		F500	500 kHz
		F50	50 kHz
		F10	10 kHz
T	Cable Type	T1	Standard cable (4.5 mm diameter)
		T2	Drag chain quality (4 mm diameter)
L	Cable Length [m]	L2	2 m
		L...	... m (on request)
		L6	6 m
C	Connector	C1	RJ45 Plug
		C2	M12 plug (male)
		C3	D-SUB 9 (male)
		C4	D-SUB 15 (male)
		C5	D-SUB 25 (female)
		C6	D-SUB 15 HD (male)
		C99	Customer specific connector.

⁽⁷⁾ standard parameters are bold

Ordering Example

IKS8-Z1P2V5D1R1F1000T1L6C1

IKS8 Magnetic Sensing Head with periodic index signal, 2 mm pole pitch, voltage 5 V, interface RS422, 1 µm resolution, max. output frequency 1000 kHz, standard cable, cable length 6 m, RJ45 connector

IKS8-Z2P5V24D3R125F50T2L2C2

IKS8 Magnetic Sensing Head with reference signal from reference marks (2-track magnetic tape), 2 mm pole pitch, voltage 7 – 32 V (broad-range), interface Push-Pull TTL, 125 µm resolution, max. output frequency 50 kHz, drag chain quality cable, cable length 2 m, M12 plug connector