

Rickmeier Solutions



Gear pumps for superior Lubrication



PUMPENTECHNOLOGIE
RICKMEIER
■ Zahnradpumpen ■ Ventile ■ Sonderprodukte ■ Systeme

#1. *Introduction*

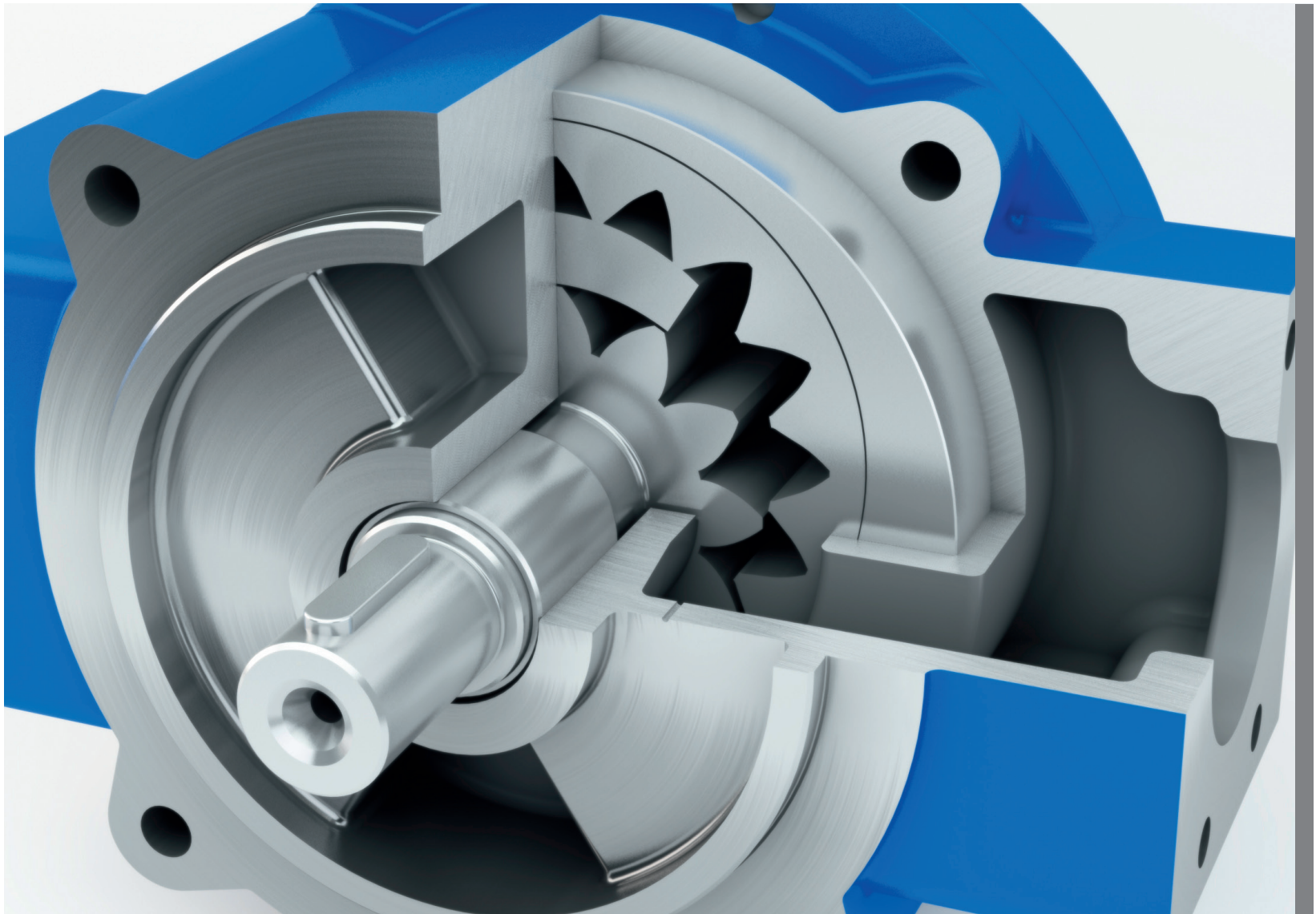

Position and significance of Rickmeier products

RICKMEIER supplies pumps, valves and systems for nearly all purposes of technical lubrication for more than 90 years.

For more than 16 years RICKMEIER pumps and lub oil supply systems, particularly developed for wind energy applica-

tions, have been working in thousands of wind power plants all over the world.

Hereto RICKMEIER delivered among others more than 100000 pcs. of pumps for world wide applications.

Contents

Page

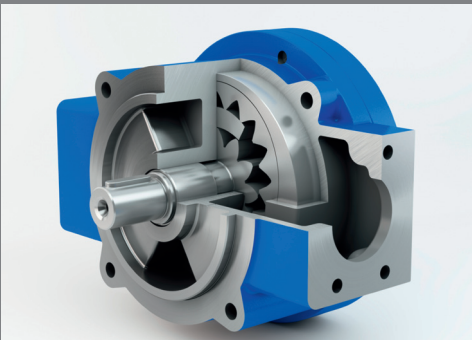
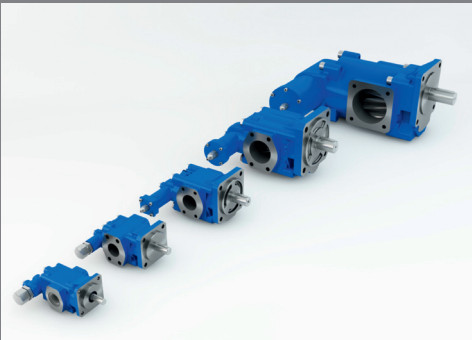

1. Introduction	2
2. Standard gear pumps (mechanically or electrically driven)	4
2.1 General description	4
2.2 Available Designs and Types of standard gear pumps „R.5“	4
2.2.1 Standard pumps and variations	4
2.2.2 Identifiers, Type code	5
2.3 Operating Limitations	5
2.4 Flow rate and speed limits of standard gear pumps „R.5“	6
3. Universal Pumps (UNI-Pumps, internal geared, mechanically driven)	7
3.1 General description	7
3.1.1 The „Universal principle“	7
3.1.2 Function	7
3.2 Available Designs and Types of universal gear pumps „UNI“	7
3.2.1 Variants of Hydraulic Connections	8
3.2.2 Driving Concepts	8
3.3 Operating Limitations	8
3.4 Flow rate and speed limits of universal gear pumps „UNI“	9
4. Rickmeier Solutions	10
4.1 2.1 MW gear box with Rickmeier UNI-Pump	10
4.2 4.4 MW gas engine with Rickmeier pumps	10
5. References	11

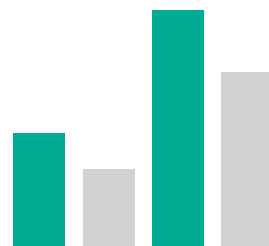

#2.

Standard gear pumps (mechanically or electrically driven)

2.1 General description

RICKMEIER gear pumps excel in a very simple and robust construction that has been represented in fig. 1. A pump in the standard version consists of the gear casing (1), driving cover (2) and end cover (3). with an option for a pressure relief valve (7) plus the hardened gear wheels (4). Compound journal bearings (5) with special coating and in ample dimension demonstrate a long life having very good dry-running capability. The shaft sealing, as a standard, is equipped with a radial shaft seal (6) or, where required, with a mechanical seal. A short and straight-line alignment of the flow channels provides for a good suction capability and quiet running. The combination with a special version of gearing and gear casing assures extremely low levels of noise during operation.

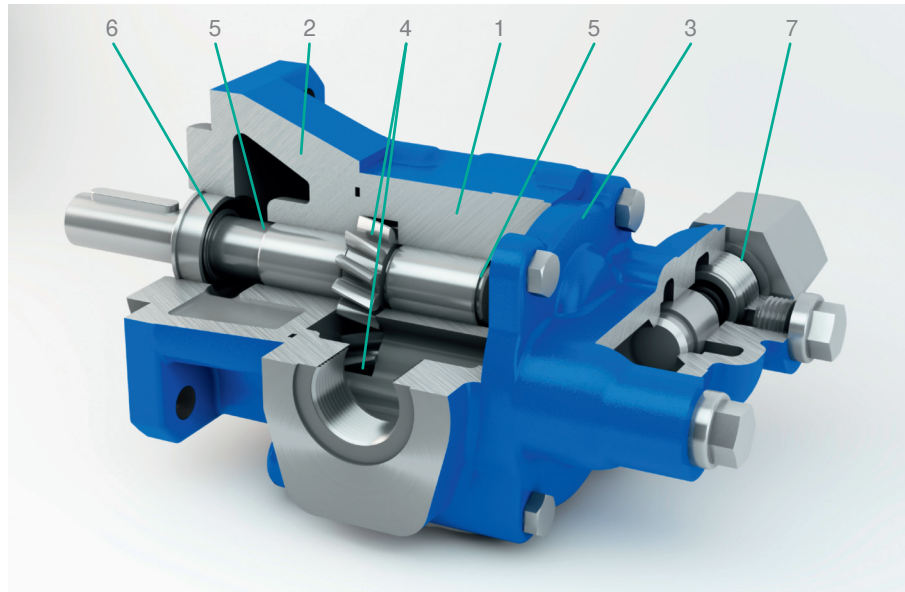

Fig. 1: gear pump, standard version

2.2 Available Designs and Types of standard gear pumps „R.5“

2.2.1 Standard pumps and variations

	Standard	Variations on request
Fix flange	Rectangular	With foot, circular, oval
Connection	R25: With thread R35, R45, R65: Metric SAE flange R95: RICKMEIER standard	Metric SAE flange DIN flange dimension DIN flange dimension
Shaft end	Cylindrical with feather key	Cylindrical without feather key conical driver, thread
Shaft seal	Radial shaft seal	Without seal, mechanical seal double seal for media separation
Pressure valve	With or without relief valve	Pressure control valve with external initiation
Flow reversal valve	None	Available for R35, R45, R65
Additional front bearing	None	Integrated in driving cover or separate bearing
No. of flow rates	Single	Double, with or without separation
Corrosion protection	1-component alkyd resin RAL 6011, approx. 30 µm	On customer's demand
Materials		
Gear casing, driving cover, end cover	EN-GJL-250 (GG-25)*	EN-GJS-400-15 (GGG-40)*
Gear wheels	Hardened steel	On request
Seals	NBR	FPM, a.o.
Journal bearings	Compound bearings	On request

* previously used descriptions

Fig. 2: Standard version and variations

2.2.2 Identifiers, Type code

RICKMEIER gear pumps are identified by the following code:

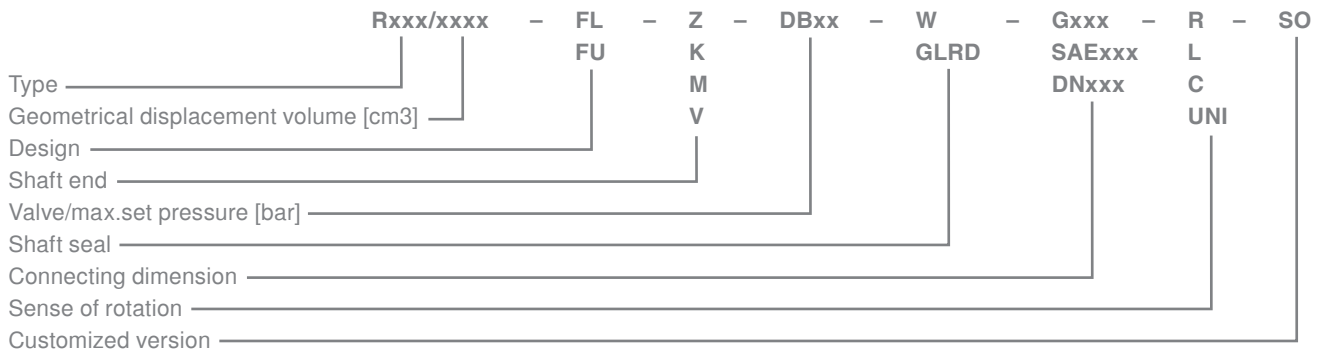

Explanation

FL Flange pump
FU Foot pump
Z Cylindrical shaft end
K Conical shaft end
M Shaft end with driver
V Shaft end with spline
DB Pressure relief valve

W Radial shaft seal
GLRD Mechanical seal
G Thread
SAE Connecting dimensions
R Rotating clockwise
L Rotating counter-clockwise
C Rotating clockwise and counter-clockwise (changing direction of flow)

DN Nominal flange dimension
UNI Direction of flow independ of sense of rotation
SO Customized version

2.3 Operating Limitations

The limitations presented herein apply for pumps in the standard version. Please contact us, whenever the specified limits need to be exceeded.

Flow medium:
 The flow medium used should demonstrate good lubricity as a condition for long lifetime and top operational safety.

If possible, the medium should be clean and non-corrosive, but in all cases free from undesirable hard constituents. Further limitations are given in fig. 3 below:

Characteristic	Unit	Min.	Max.
Kinematic viscosity	mm ² /s	5	100000 ¹⁾
Degree of fluid contamination	ISO 4406	—	21/19/17
Gas content (undissolved)	Vol.-%	—	10 ²⁾
Temperature (NBR seals) operation	°C	-30	80
Temperature (NBR seals) survival	°C	-40	85
Temperature (FKM seals) operation	°C	-20 (-40 on request)	
Gear pump unit			130 ³⁾
Flange pump			160 ³⁾
Temperature (FKM seals) survival	°C	-30 (-40 on request)	
Gear pump unit			130 ³⁾
Flange pump			160 ³⁾
Suction pressure radial shaft seal, operation	bar ⁴⁾	-0.4	0.5
Suction pressure radial shaft seal, standstill	bar ⁴⁾	-0.4	5
Suction pressure mechanical shaft seal, operation	bar ⁴⁾	-0.4	10
Suction pressure mechanical shaft seal, standstill	bar ⁴⁾	-0.4	10

1) Depending on pump speed, see fig. 5

2) Undissolved gas in the medium may cause higher noise emissions

3) The use above 80°C may require particular measures (e.g. high temperature couplings or springs etc.)

4) Manometric

Fig. 3: Operating limitations



2.4 Flow rate and speed limits of standard gear pumps „R.5“

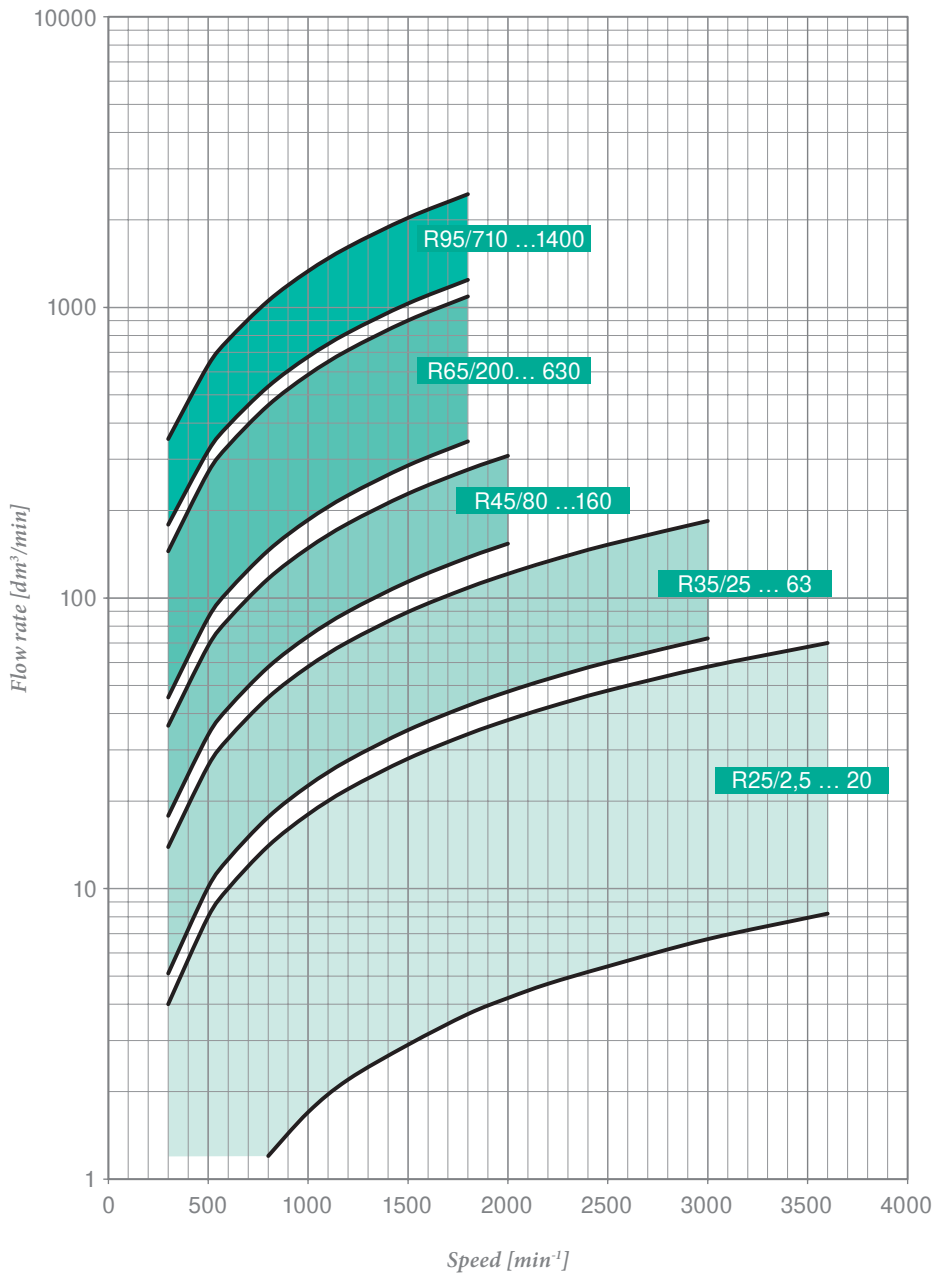

Kinematic viscosity $\nu = 100 \text{ mm}^2/\text{s}$
 Outlet pressure $p_2 = 12 \text{ bar}$
 Max. operating pressure $p_2 = 25 \text{ bar}$

Fig. 4: Flow rate versus speed for standard gear pumps

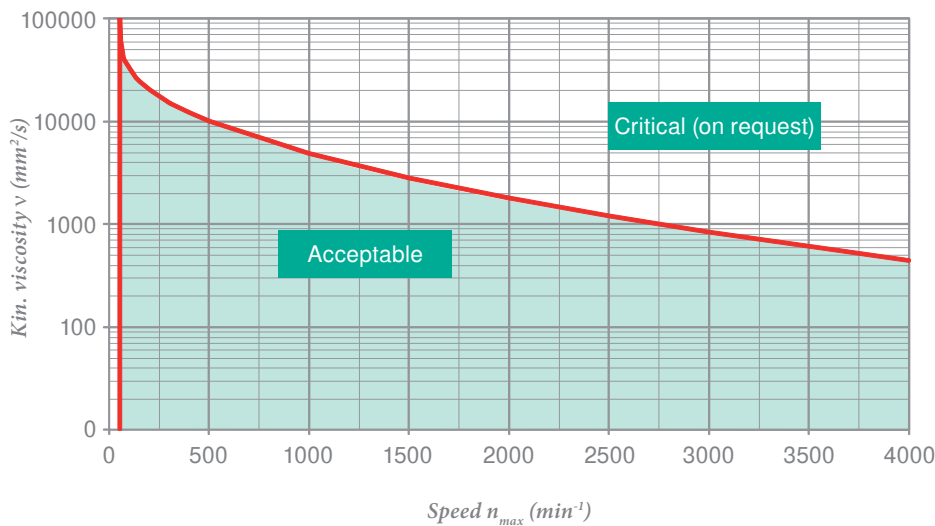

Always: Suction pressure $p_1 \text{ abs.} > 0.6 \text{ bar}$

Fig. 5: Speed versus kinematic viscosity

#3.

Universal Pumps (UNI-Pumps, internal geared, mechanically driven)

3.1 General description

3.1.1 The “Universal principle“

RICKMEIER universal pumps (“UNI-Pumps”) are a special type of gear pumps. While the direction of flow in standard gear pumps depends directly on the sense of rotation of the pump and automatically reverses if the sense of rotation changes, RICKMEIER UNI-Pumps feature a special design. They are configured to ensure that the direction of flow remains the same irrespective of a change in the sense of rotation of the driver.

This characteristic is particularly beneficial in applications in which the sense of

rotation can reverse although the direction of the flow medium is not permitted to change, for instance when transporting lubricating oils in turbine gearboxes, marine gears or compressors. In addition, RICKMEIER UNI-Pumps also benefit from excellent suction capability even when conveying ultra-high viscosity oil, very quiet running and a durable, highly compact design.

All these characteristics make RICKMEIER UNI-Pumps highly suited for use in wind turbine gearboxes, where for instance

installation of the wind turbine in cold weather zones (CCV) imposes extreme demands on the gear oil feed pumps.

Another characteristic of RICKMEIER UNI-Pumps which is highly valued in the wind power sector is the omission of wearing components such as contact seals and valves. This ensures that these pumps continue to provide optimum service to users over extremely long operating periods without any maintenance requirements.

3.1.2 Function

The pump basically consists of an outer casing (1) with pipe connections, the gear casing (2), the driving gear shaft (3) and the annulus (4).

The gear casing (2), which is hydraulically linked to the outer casing (1) by means of suction and pressure openings, can be rotated in the outer casing (1) and can basically be located in 2 positions which are at 180° to one another. The driving gear shaft (3) drives the annulus (4). Dependent on the sense of rotation, the gear casing will taken (2), so that the canals existing in it with that suction and pressure connections in the outer casing (2), to the cover reaches and the support enables.

If the direction of rotation of the driving gear shaft (3) is reversed, the gear casing (2) is

also rotated in the opposite direction, so that now suction and pressure sides of the gear casing (2) are connected with the opposite connections of the outer casing (1).

The result is that the flow medium now, despite a different direction of rotation of the gear wheels in the inside, uses the same outer connections of the pump for inlet and outlet, i.e. the direction of flow remains unchanged, as desired.

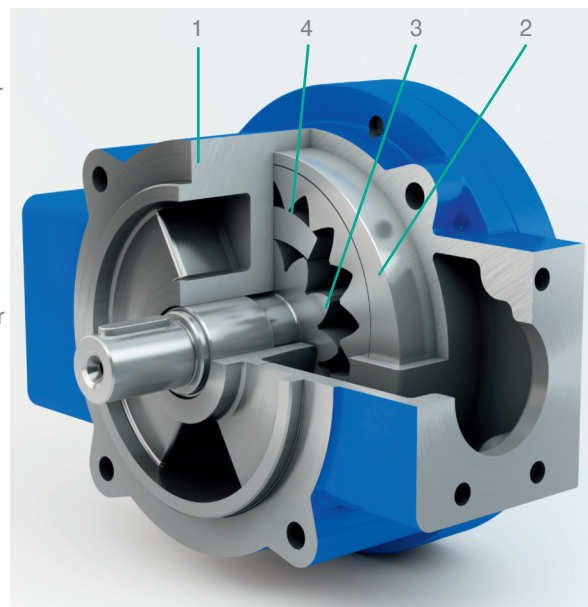
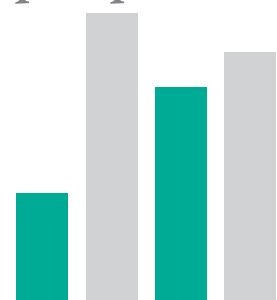

Fig. 6: UNI-Pump

3.2 Available Designs and Types of universal gear pumps „UNI“

The range of positive displacement volume covers currently from 35 cm³/rev to 160 cm³/rev.

Other displacement volumes are possible as well (customization). The flow rate depends on the gear pump speed.



3.2.1 Variants of Hydraulic Connections

The following pictures demonstrate opportunities for different hydraulic connections

(others on request):

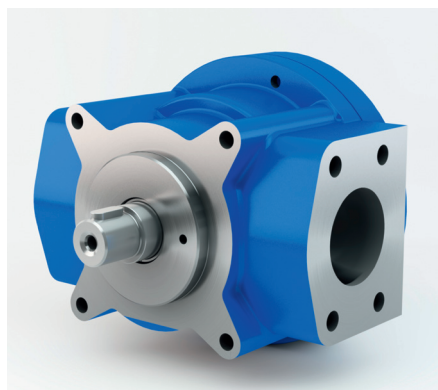

a) Flange connection

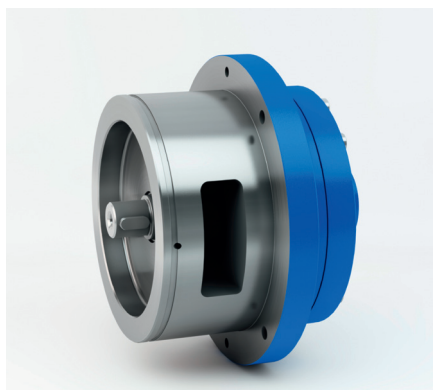

b) Plug in pump
(no pipework)

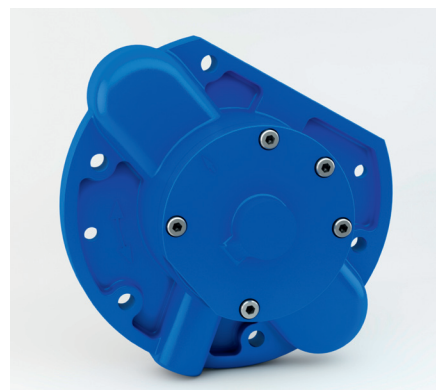

c) Face mounting pump
(customized, pipework integrated)

3.2.2 Driving concepts

The following pictures demonstrate opportunities for different driving concepts

(others on request):

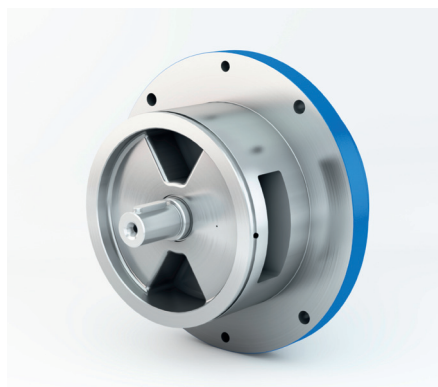

a) Shaft end for coupling
with paralel key



b) Pinion gear drive
and add. bearing



c) Special coupling
(customized solution)

3.3 Operating Limitations

Characteristic	Unit	Min.	Max.
Kinematic viscosity	mm ² /s	7	100000 ¹⁾
Degree of fluid contamination	ISO 4406	-	21/19/17
Gas content (undissolved)	Vol.-%	-	10 ²⁾
Temperature (NBR seals) operating	°C	-30	80
Temperature (NBR seals) survival		-40	
Temperature (FKM seals) operating	°C	-20 (-40 on request)	100
Temperature (FKM seals) survival		-30 (-40 on request)	
Suction pressure	bar ³⁾	-0,5	0

1) Depending on pump speed, see fig. 8

2) Undissolved gas in the medium may cause higher noise emissions

3) Manometric

3.4 Flow rate and speed limits of universal gear pumps „UNI”

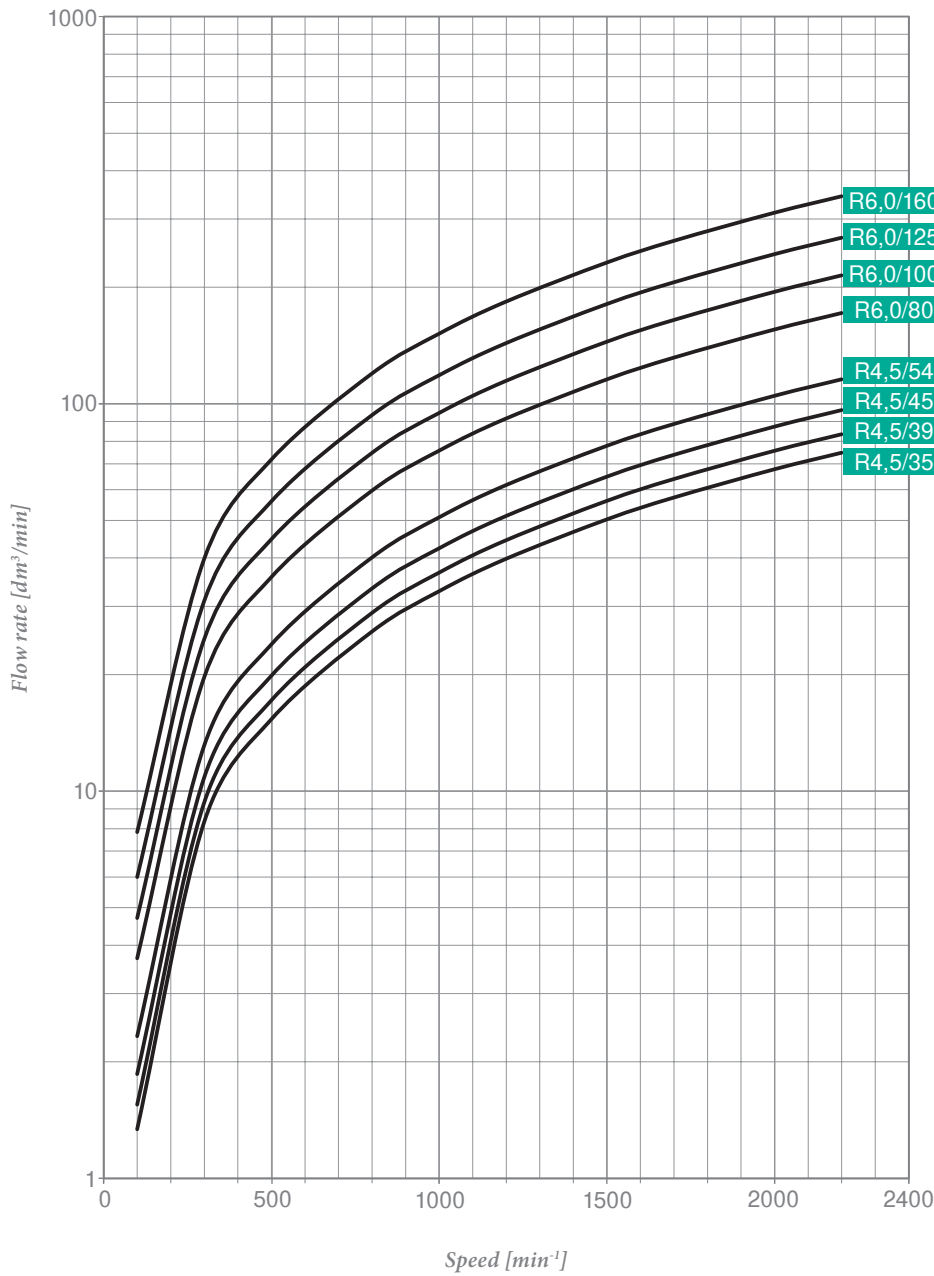

Kinematic viscosity $\nu = 100 \text{ mm}^2/\text{s}$
 Outlet pressure $p_2 = 12 \text{ bar}$
 Max. operating pressure
 $p_2 = 25 \text{ bar}$

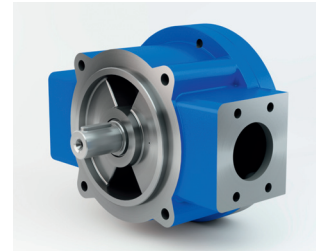

Example:
 R 6,0/160 FL-Z-SAE2.1/2-UNI-...
 Approx. 230 dm³/min @ 1500 r/min
 Max. pressure = 25 bar



Example:
 R 4,5/35 FL-Z-G1-UNI-...
 Approx. 50 dm³/min @ 1500 r/min
 Max. pressure = 25 bar

Fig. 7: Flow rate versus speed for universal gear pumps „UNI”

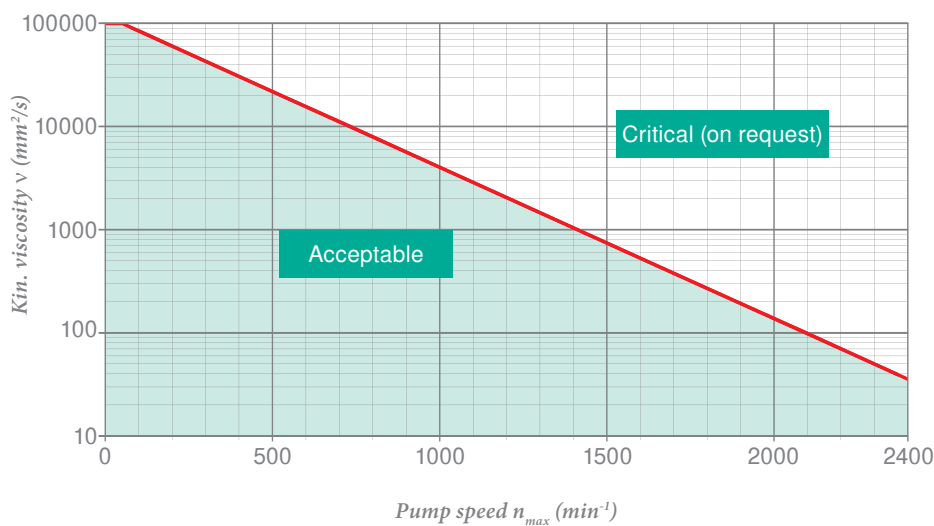

Always: $p_1 \text{ abs.} > 0.6 \text{ bar}$

Fig. 8: Speed versus kinematic viscosity

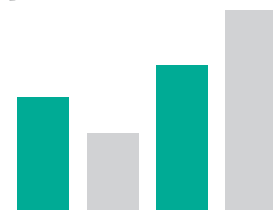

#4. Rickmeier Solutions

4.1 2.1 MW gear box with Rickmeier UNI-Pump



Wind energy gear box
Nominal power: 2.1 MW

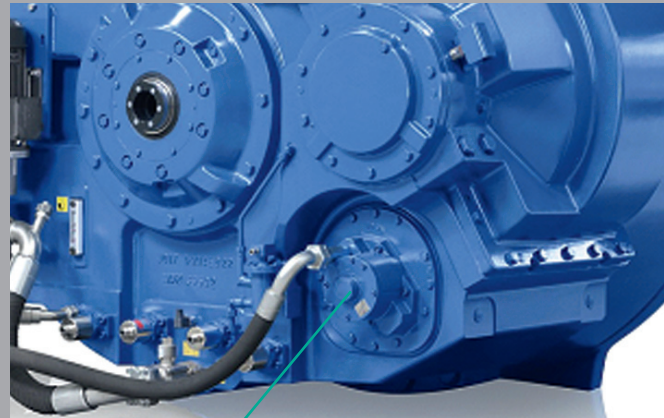

Rickmeier product:
UNI-Pump R4,5/35 with internal and external oil flow
Main data: Appr. 66 dm³/min @ 2000 rpm
Working pressure: Max. 25 bar

4.2 4.4 MW gas engine with Rickmeier main and auxiliary oil pumps

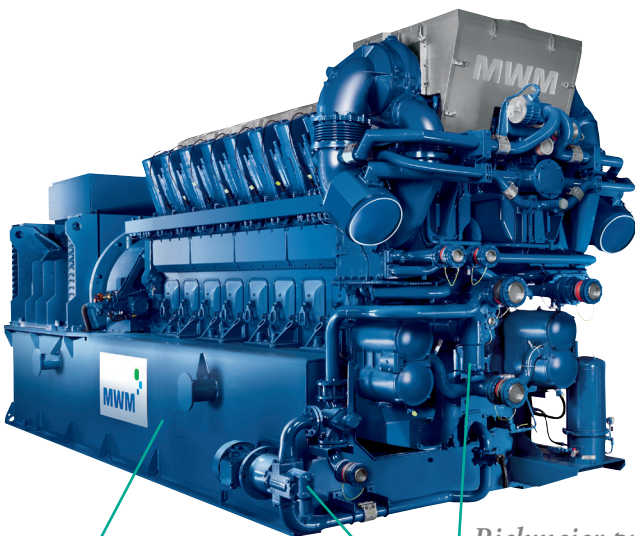

Genset gas engine
Nominal power: V12 3.4 MW
V16 4.4 MW
Speed: 1000 rpm

Rickmeier products:
1. Main pump: R95/1400
Appr. 2200 dm³/min @ 1700 rpm
Working pressure: 12 bar (max. 25 bar)
2. Auxiliary pump: R65/630
Appr. 860 dm³/min @ 1450 rpm
Working pressure: 5 bar (max. 25 bar)

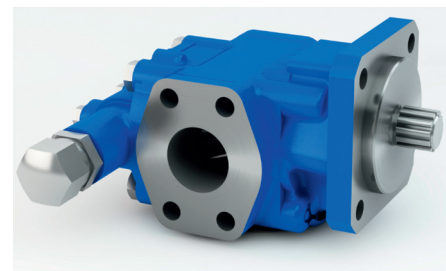

Optional Rickmeier product for Diesel engines:
Fuel oil pump: R35/50
Appr. 70 dm³/min @ 1800 rpm
Working pressure: 13 bar (max. 25 bar)
Suction pressure: 0.6 bar abs.
Kin. Viscosity: 4 mm²/s

#5. References

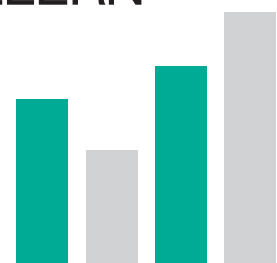

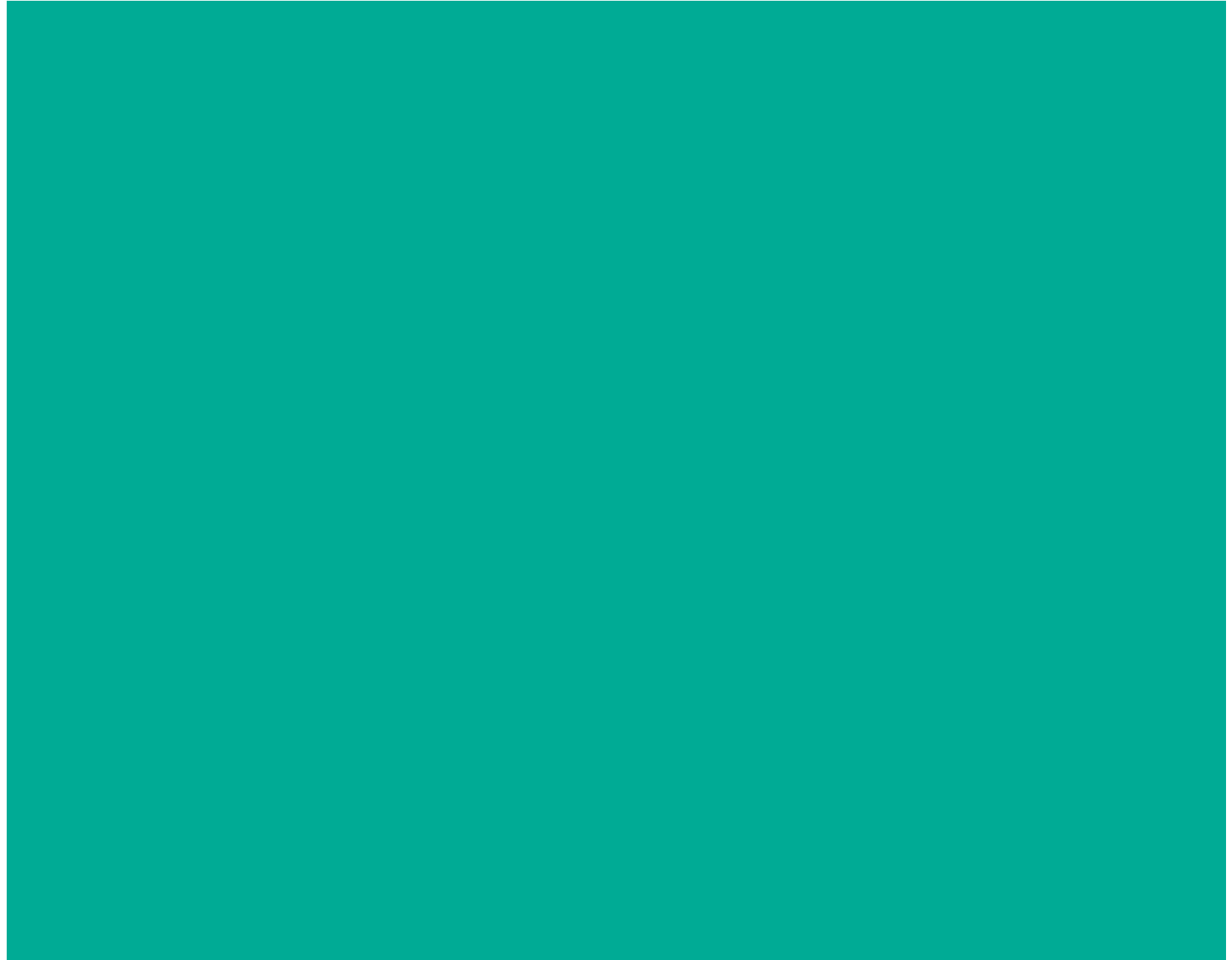
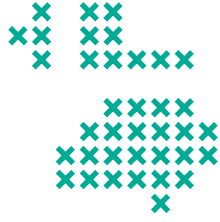
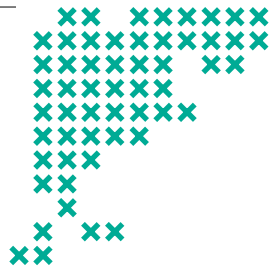

PUMPENTECHNOLOGIE
RICKMEIER
■ Zahnrädumpumpen ■ Ventile ■ Sonderprodukte ■ Systeme

RICKMEIER GmbH
Langenholthäuser Str. 20 – 22
D-58802 Balve
Phone +49 (0) 2375 927 - 0
Fax +49 (0) 2375 927 - 26
kontakt@RICKMEIER.com
www.RICKMEIER.com

