

# Magnescale

SPEED X PRECISION

# Magnescale

SPEED X PRECISION

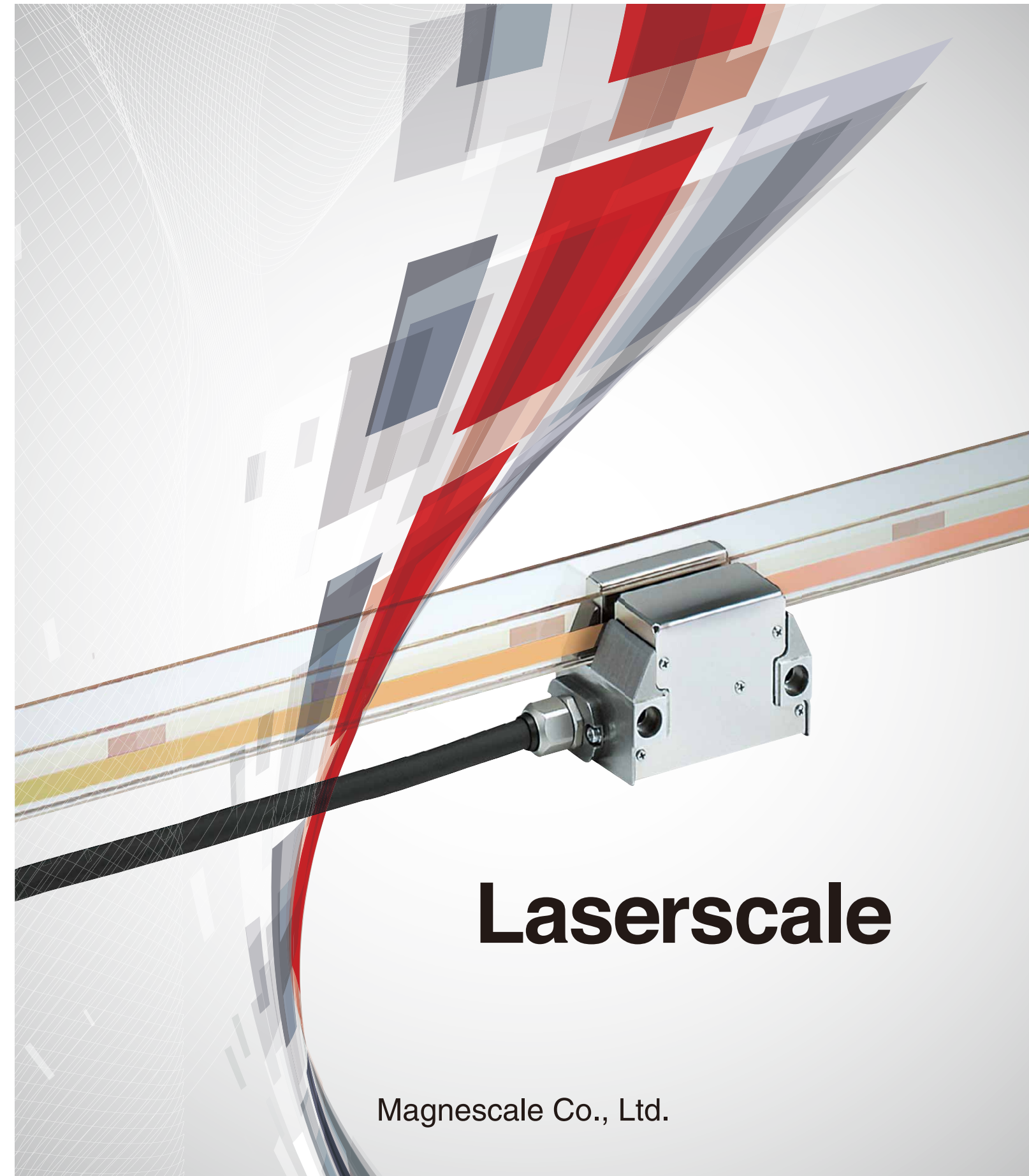

# Laserscale

Magnescale Co., Ltd.

## Magnescale Co., Ltd.

International Sales Department	3-1-4 Edagawa, Koto-ku, Tokyo 135-0051, Japan	TEL.+81(0)3-6632-7924	FAX.+81(0)3-6632-7928	E-mail : info-mgs-eng@magnescale.com
Magnescale Americas Inc.	1 Technology Drive, Suite F217, Irvine, CA 92618, USA	TEL.+1(949)727-4017	FAX.+1(949)727-4047	E-mail : info-am@magnescale.com
Magnescale Europe GmbH	Antoniusstrasse 14, 73249 Wernau, Germany	TEL.+49(0)7153-934-291	FAX.+49(0)7153-934-299	E-mail : info-eu@magnescale.com
Service & Parts	45 Suzukawa, Isehara-shi, Kanagawa 259-1146, Japan	TEL.+81(0)463-92-2132	FAX.+81(0)463-92-3090	E-mail : info-css@magnescale.com

<http://www.magnescale.com>

The contents of this literature are as of June 2018. Magnescale reserves the right to change product specifications without prior notice.  
This catalog is printed with soy ink.  
MGS-LS-1806-EN-C

# Safety

No compromise for high-accuracy products



The total quality control system that operates throughout the entire design and production process ensures products with enhanced safety, high quality, and high reliability that match our customers' requirements. The company is certified for length calibration in compliance with the traceability system required by the "Weights and Measures Act," and has been granted ISO 9001 certification, which is the international standard for quality assurance.



Magnescale Co., Ltd. is registered to ISO 9001 (Quality)

**Our products comply with CE Marking requirements, have acquired UL certifications and meet other regulations, ensuring safe use the world over.**

We have met:

•EMC Directives(CE)

EMI: EN 55011 Group 1 Class A

EMS: EN 61000-6-2

•FCC regulation

FCC Part 15 Subpart B Class A

for Products with built-in AC power supply:

• UL61010-1 • EN61010-1

for Products with Laser:

• DHHS (21CFR1040.10) • IEC60825-1

\* When using our devices with machines to which the European Machinery Directive applies, please make sure that the devices when installed on the machines fulfill the applicable requirements of the Directive.  
\* Standards or regulations to be complied with may vary by product.

# Traceability

Traceability Flow Chart (Length)

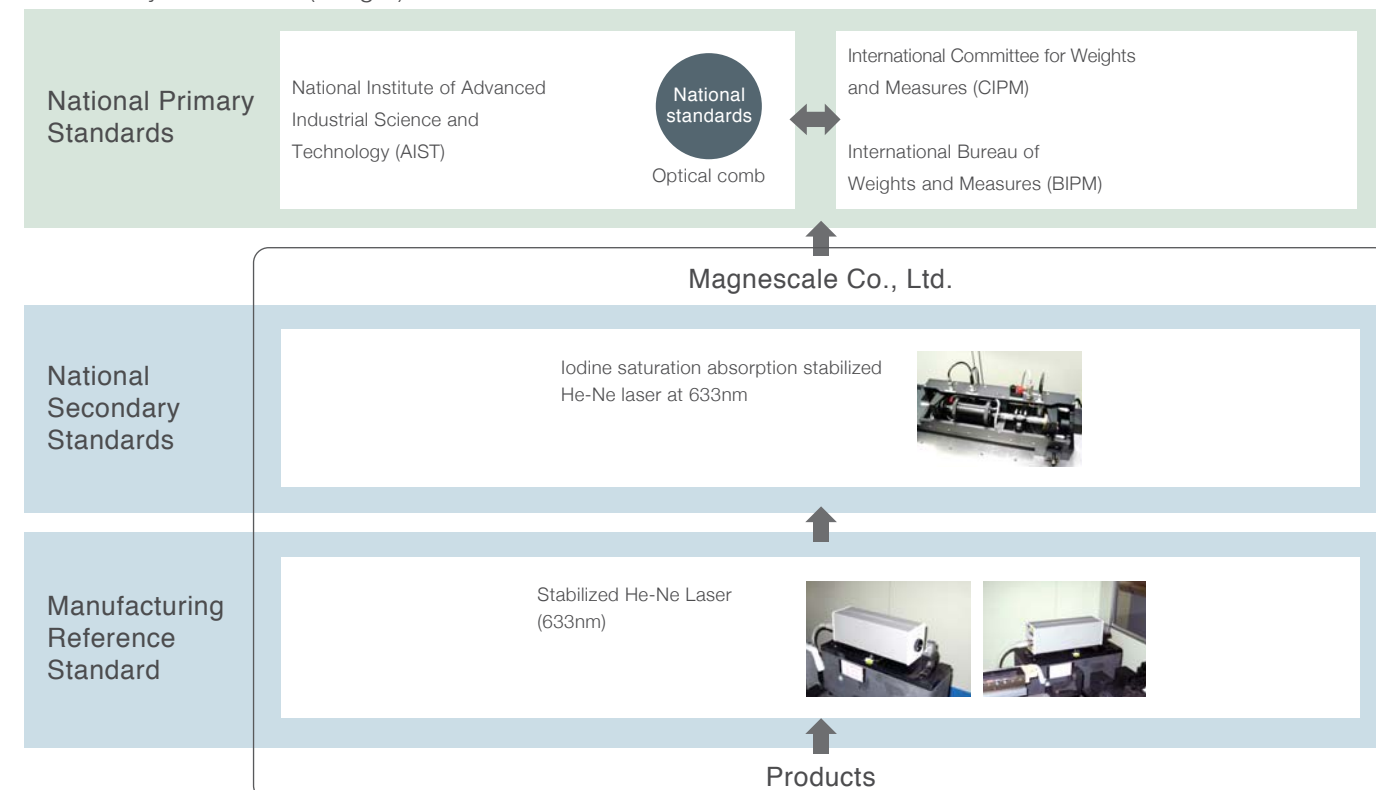

PD

LD

# Laserscale

## Contents

Safety	2
Traceability	2
Contents	3
Introduction	4
Principle	6
Application	7
Lineup	8
BS78	10
BS65-R	14
BH25-RE/BH25-NE	16
BH20-RE/BH20-NE	18
BL57-RE/BL57-NE	20
BD96	26
BD95	27
Connection Cable	28
Technology	29

\* The product name "Laserscale" is trademark of Magnescale Co., Ltd.

# What's Laserscale?

## The world of super-resolution is going further than 1nm

Laserscale easily achieves measurement and control with ultra high resolution of better than 1nm.  
 A sinusoidal wave (approximately 138nm signal pitch) is generated using the grating interference method by utilizing a holographic scale with high diffraction efficiency and a high resolution head.  
 The BS series offers strong resistance to disturbance by air pressure or current, and is easy to install. Signal distortion, in principle, remains minimal at a high S/N ratio.  
 Resolution of 17pm can be achieved using our automatic compensation interpolator.



138nm

High-resolution scale with signal pitch of approx. 138nm outperforms light wave interferometer systems

**Ultra-high resolution**  
 Volume holography technology of Laserscale achieves high diffraction efficiency to generate a high S/N signal and a strong output signal.

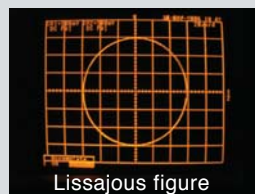

**Best in class 17pm resolution**  
 One count movement of the 0.55µm holographic grating pitch diffracts the signal to 4 periods. The 1/4 of the original signal results in a signal of approximately 0.138µm. Using our interpolator, this signal can achieve 17pm resolution.

**Ultra-high resolution and high response speed**  
 Our grating interference principle linear encoders offer a signal pitch of approximately 0.14µm. That is 1/140th of a conventional linear encoder with a 20µm signal pitch. Using our interpolator, 17pm resolution and a response speed of up to 400mm/s is achievable.

Model	Output	Max. divisions	Resolutions	Max. response speed
BS series Signal pitch: 138nm	Binary	8000	17 pm	400mm/s
	A/B quadrature	32	4.31 nm	60mm/s

High stability : Free from temperature, air pressure, or air disturbances

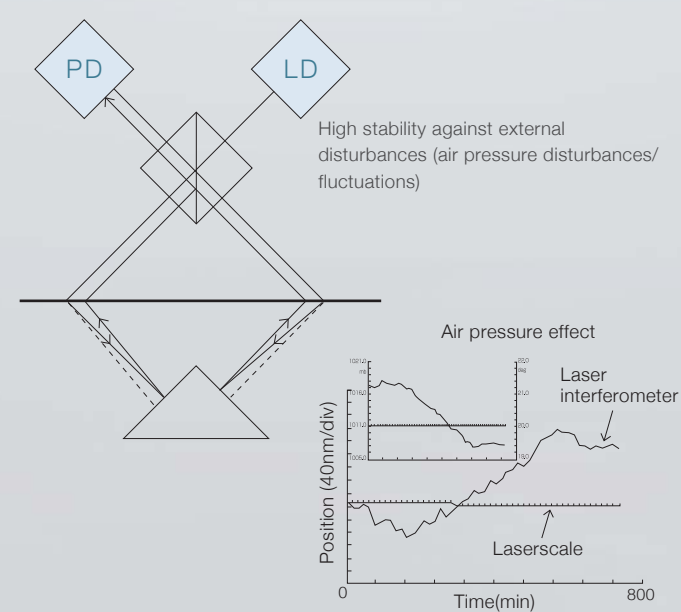
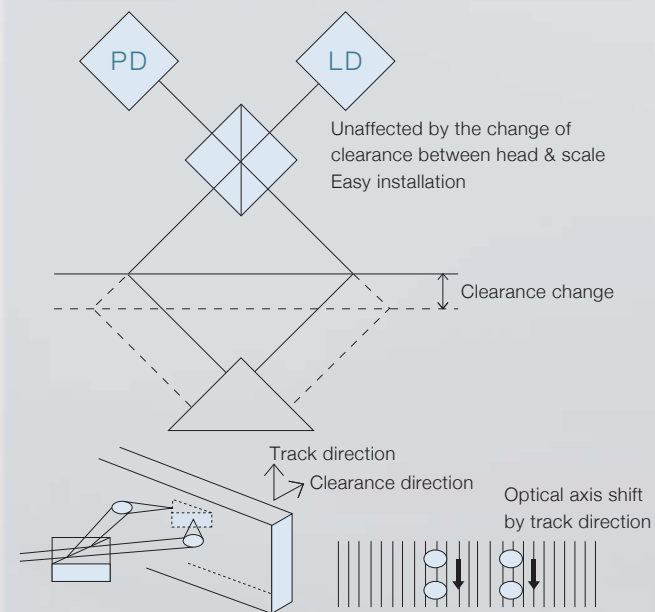

Easy installation & maintenance

[Easy installation & maintenance]  
 Large installation tolerances  
 Easy installation and non-contact detection

No electrical adjustment after installation  
 Despite the high installation tolerances, no electrical adjustment is required after installation.

Protected holographic grating  
 The holographic grating is protected by glass covers which guard the grating against external pressure. The glass can be wiped to clean dust and dirt.

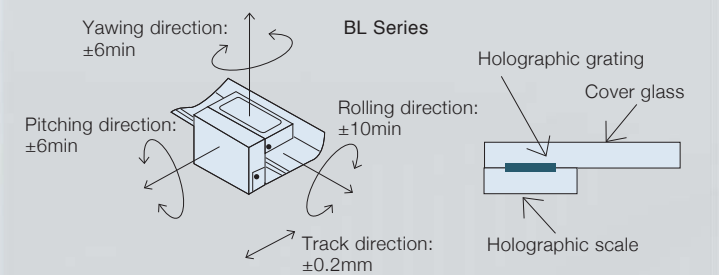

# Principle

The semiconductor laser beam is split by a polarized light beam splitter into S and P polarized light beams, then diffracted through a volume holographic grating with very high diffraction efficiency. The two diffracted beams pass through separate 1/4-wavelength plates to a mirror, which reflects the beams back through the plates. This process converts the S polarized beam to P polarized light and the P polarized beam to S polarized light. The two beams are diffracted again through the volume holographic grating, then super-positioned by the polarized light beam splitter to create interference. All interference travels to the photo-detector side due to conversion of the polarization direction. Since double diffraction adds  $+2Kx$  and  $-2Kx$  phases to each beam, the interference is subject to four light-dark inversion cycles for each grating scale of movement. Thus a grating pitch of  $0.55\ \mu\text{m}$  produces a signal pitch of  $0.55/4 = \text{approx. } 0.138\ \mu\text{m}$ . This detecting optics is free from fluctuations and change in air pressure, since the light path of both left and right changes identically even with the change in wavelength of the optical source. Repeatability and returning errors do not occur in principle.

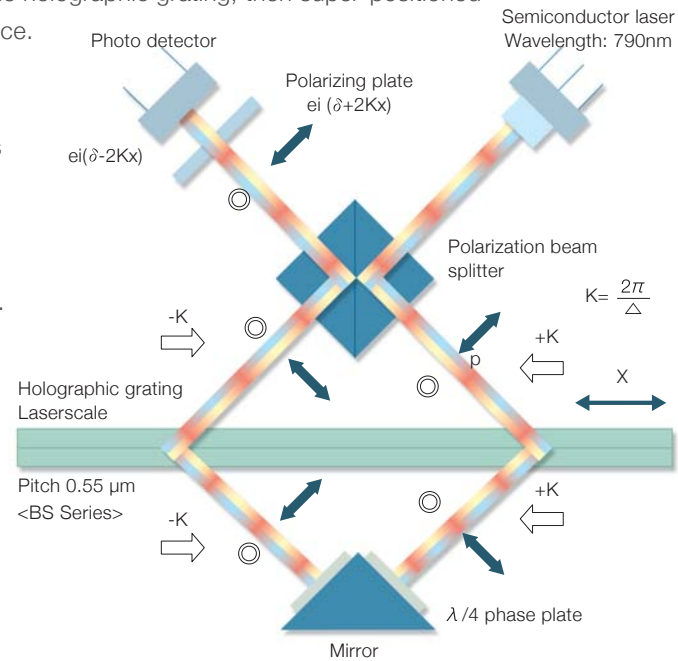

↔: Direction where light vibrates...Right and left    ⊙: Direction where light vibrates...Back and forth

## Laser beam passage (Transmission)

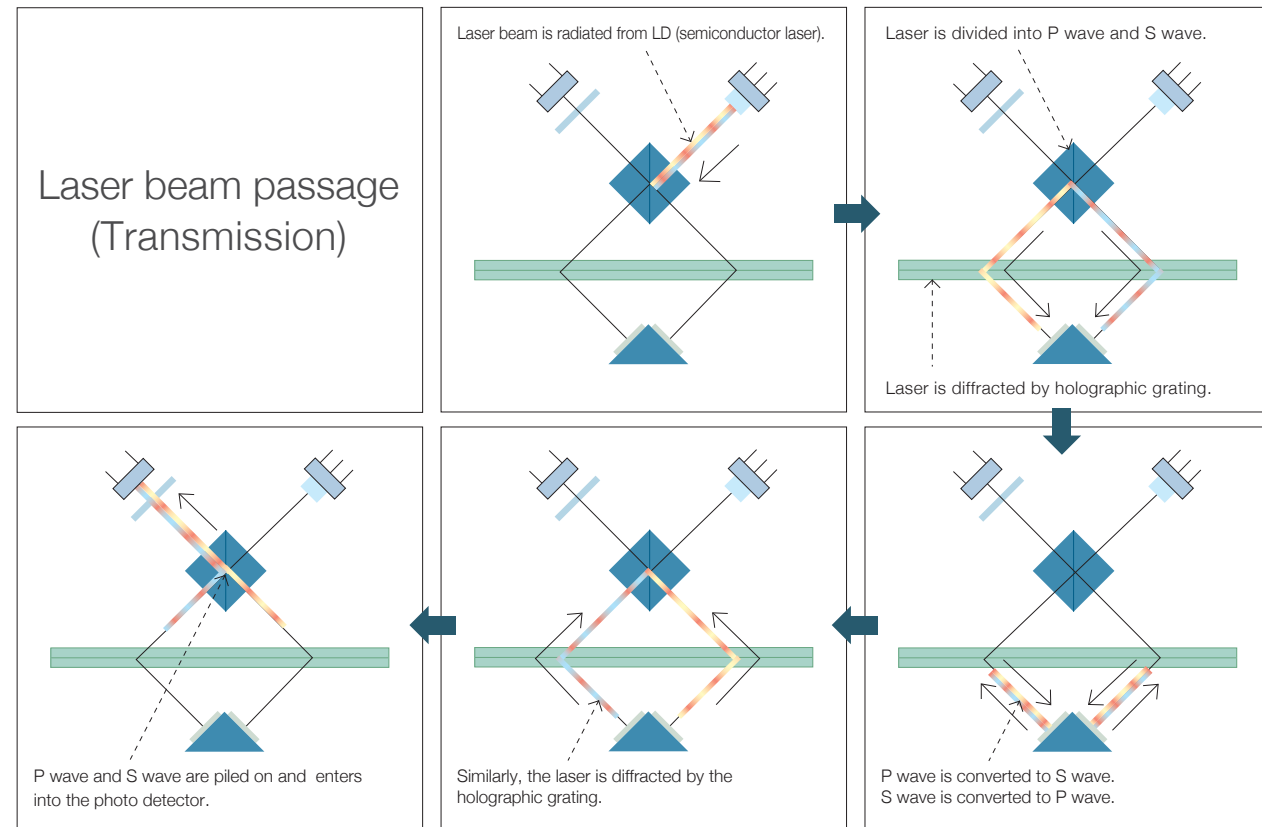

# Application

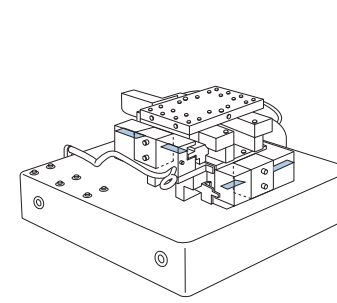

Ultra high precision air stages (vacuum resistant)

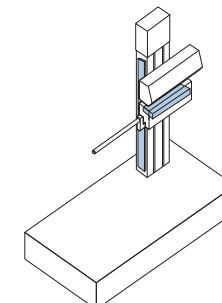

Surface roughness/contour measuring machines

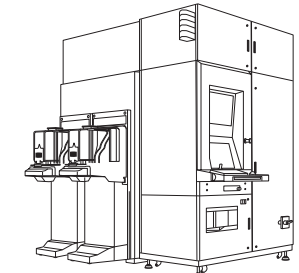

DUV-based automatic wafer defect classification systems

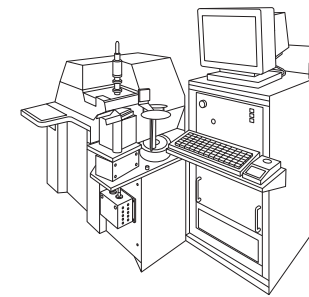

Non-contact measuring machines

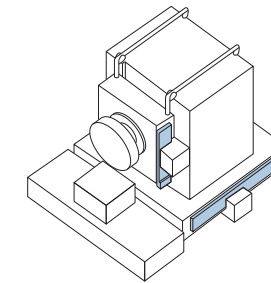

Micro grinders

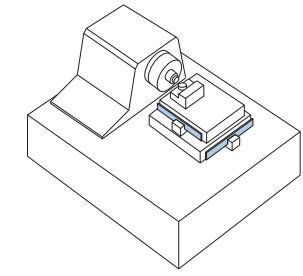

Aspherical surface machining



# Lineup

	Series	Feature	Minimum resolution	Scale accuracy	Measuring length	Interpolator	Output	Max. response speed	Page
<p><b>BS</b></p> <p><math>\lambda</math>=approx. 138nm Transmission</p> 	BS78	Low expansion glass	17pm	$\pm 0.04\mu\text{m}$ (Measuring length 40mm)	10mm~420mm	BD96 (BD95)	40bit Binary	400mm/s	P.10
							Serial		
	BS65-R	Long length type Soda-lime glass	17pm	L<460: (0.1+0.4L/100) $\mu\text{m}$ p-p L $\geq$ 460:3 $\mu\text{m}$ p-p L:Measuring length(mm)	160mm~960mm	BD96 (BD95)	40bit Binary	400mm/s	P.14
							Serial		
<p><b>BH</b></p> <p><math>\lambda</math>=250nm Reflection</p> 	BH25-RE/NE	Low expansion glass Soda-lime glass	31.25pm	$\pm 0.5\mu\text{m}$ (30mm-170mm) $\pm 1\mu\text{m}$ (220mm-420mm)	Low expansion glass: 30mm~420mm Soda-lime glass: 30mm~420mm	BD96	40bit Binary	700mm/s	P.16
							Serial		
	BH20-RE/NE	302,400Pulse/rotation 680,400Pulse/rotation 907,200Pulse/rotation 1,048,576Pulse/rotation	1.5nrad	—	Radius 12.03mm Radius 27.07mm Radius 36.10mm Radius 41.72mm	BD96	40bit Binary	$555\text{min}^{-1}$ $(1,428\text{min}^{-1}, 634\text{min}^{-1})$ $(476\text{min}^{-1}, 411\text{min}^{-1})$	P.18
							Serial		
<p><b>BL</b></p> <p><math>\lambda</math>=400nm Transmission</p> 	BL57-RE	Low expansion glass Soda-lime glass	0.1/0.05/0.02/ 0.01 $\mu\text{m}$	$\pm 0.5\mu\text{m}$ (30mm-160mm) $\pm 1\mu\text{m}$ (210mm-360mm) $\pm 1.5\mu\text{m}$ (410mm-1,060mm)	Low expansion glass: 30mm~410mm Soda-lime glass: 60mm~1,060mm <small>Please ask for more than 1,060mm</small>	Built-in I/F Box	A/B quadrature	1,500, 650, 300, 120mm/s	P.20
					0.4 $\mu\text{m}$ (1Vp-p)			NONE	
	BL57-NE	Low expansion glass Soda-lime glass	0.1/0.05/0.02/ 0.01 $\mu\text{m}$	$\pm 0.5\mu\text{m}$ (30-170mm) $\pm 1\mu\text{m}$ (220-370mm) $\pm 1.5\mu\text{m}$ (420-1,060mm)	Low expansion glass: 30mm~420mm Soda-lime glass: 60mm~1,060mm <small>Please ask for more than 1,060mm</small>	Built-in I/F Box	A/B quadrature	1,500, 650, 300, 120mm/s	
				0.4 $\mu\text{m}$ (1Vp-p)			NONE	Analog	

# BS

## BS78 (with/without reference point)

High-speed and high-resolution, while maintaining stable, ultraprecision measuring. Ideal for precision stages, semiconductor inspection/manufacturing systems, and ultraprecision processing machines.

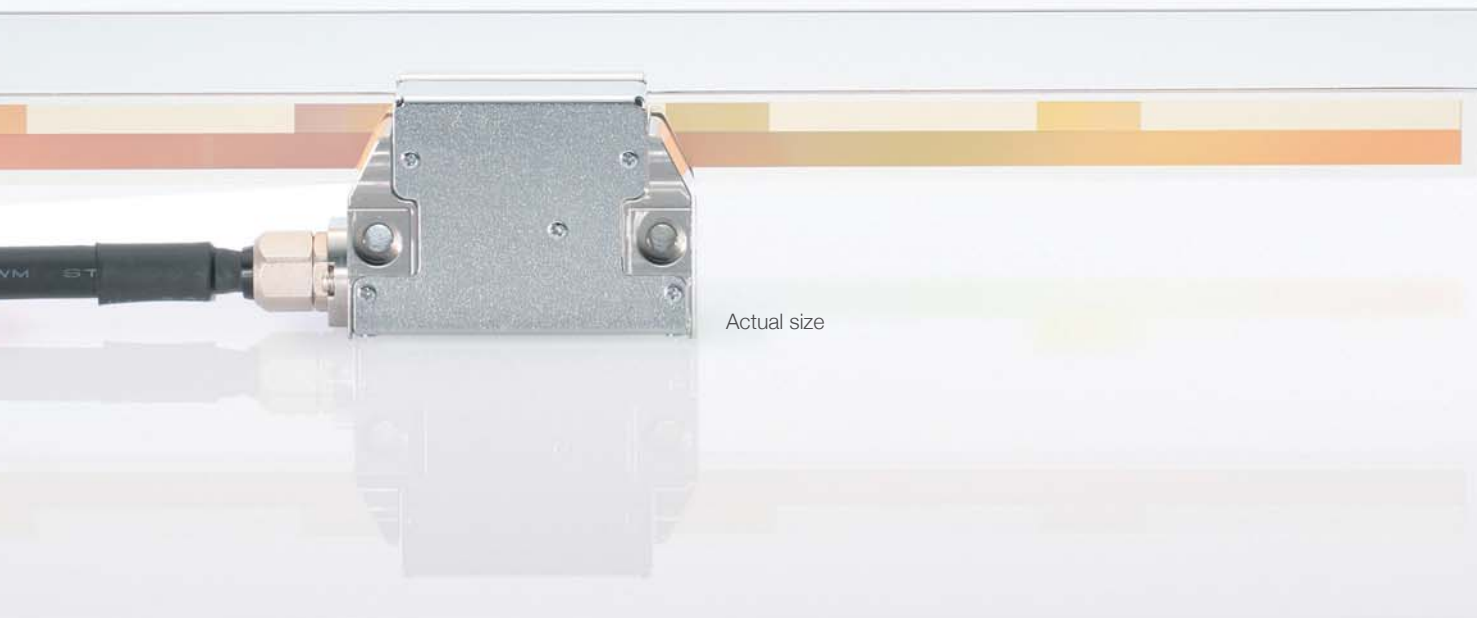

Actual size

- High-resolution scale with signal pitch of approx. 138nm, outperforming light wave interferometer systems
- High stability, unaffected by humidity, air pressure and air disturbances
- Reference point accuracy :  $\pm 0.1\mu\text{m}$
- Scale accuracy :  $\pm 0.04\mu\text{m}$  (measuring length : 40 mm)
- Non-contact design eliminates return error.
- Special non-magnetic and vacuum-compatible models available
- Using low expansion glass :  $-0.7 \times 10^{-6}/^{\circ}\text{C}$  (measuring length : 10 to 420 mm)



R: with reference point;  
RS: high accuracy with reference point  
N: without reference point;  
NS: high accuracy without reference point  
Type example : BS78-220R  
Measuring length

### External Dimensions

#### ● BS78-xxxR(RS) (Measuring length : 40/120/170/220/370/420 mm)

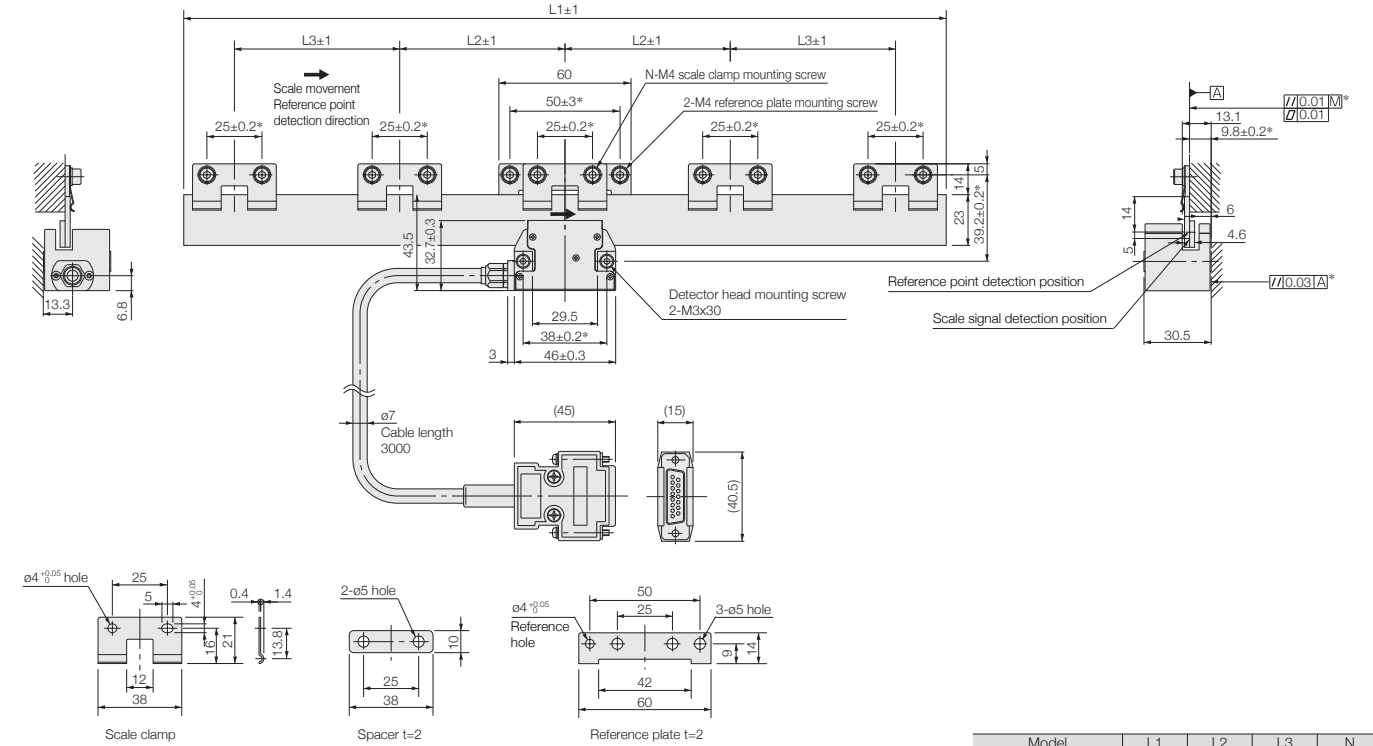

Note 1: The items marked by an asterisk indicate the machining dimensions on the mounting surface.  
Note 2: The surface properties of the scale mounting surface is  $R_{\text{max}} = 6.3\text{S}$ .  
Note 3: The surface properties of the detector head mounting surface is  $R_{\text{max}} = 12.5\text{S}$ .  
Note 4: "M" refers to the machine guide.  
Note 5: Mount and adjust the paired reference plates so that their reference surfaces have a parallelism of 0.01 or less with respect to the machine guide.  
Note 6: Reference point detection direction : Standard (Scale movement direction→ with the head stationary)

Model	L1	L2	L3	N
BS78-40R (RS)	66	—	—	2
BS78-120R (RS)	146	50	—	6
BS78-170R (RS)	196	75	—	6
BS78-220R (RS)	246	100	—	6
BS78-370R (RS)	396	75	75	10
BS78-420R (RS)	446	100	100	10

Unit: mm

#### ● BS78-xxxR(RS) (Measuring length : 70/270/320 mm)

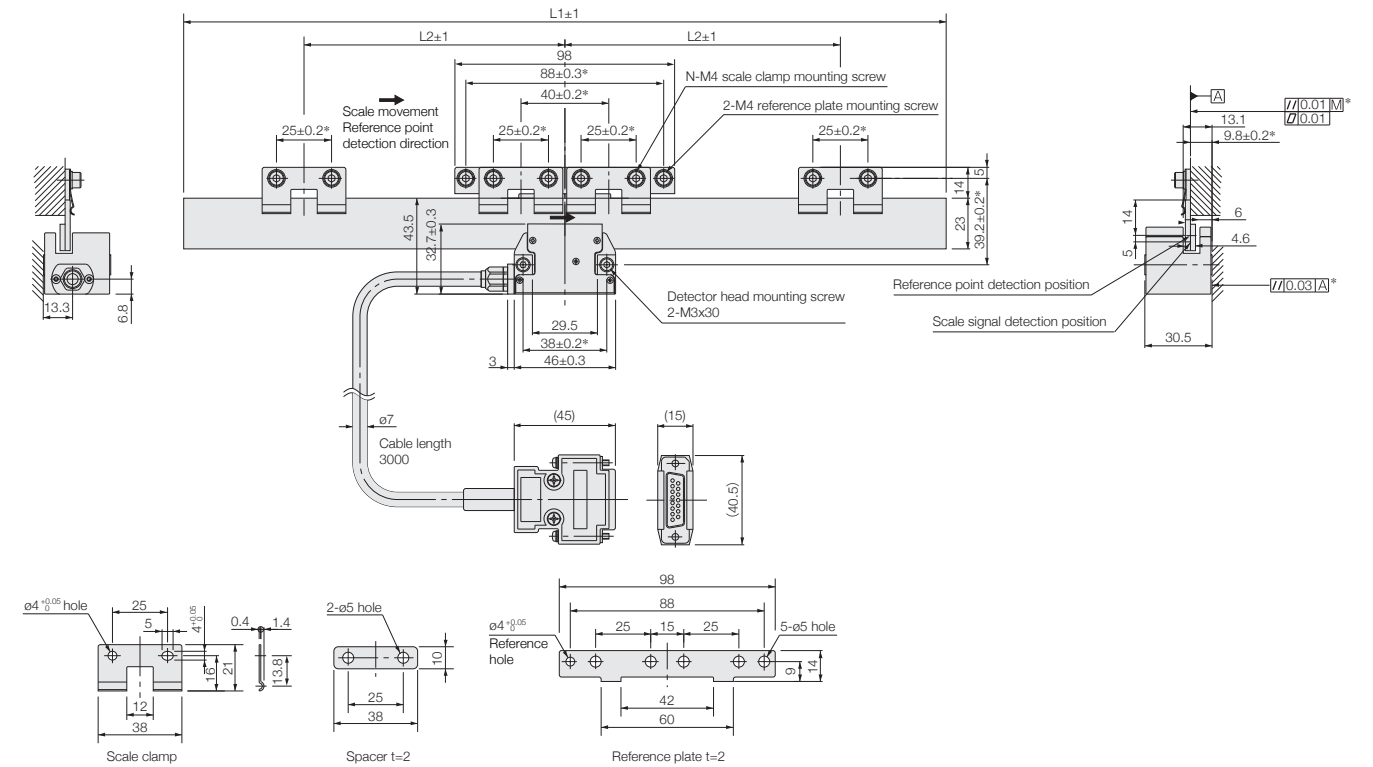

Note 1: The items marked by an asterisk indicate the machining dimensions on the mounting surface.  
Note 2: The surface properties of the scale mounting surface is  $R_{\text{max}} = 6.3\text{S}$ .  
Note 3: The surface properties of the detector head mounting surface is  $R_{\text{max}} = 12.5\text{S}$ .  
Note 4: "M" refers to the machine guide.  
Note 5: Mount and adjust the paired reference plates so that their reference surfaces have a parallelism of 0.01 or less with respect to the machine guide.  
Note 6: Reference point detection direction : Standard (Scale movement direction→ with the head stationary)

Model	L1	L2	N
BS78-70R (RS)	96	—	4
BS78-270R (RS)	296	120	8
BS78-320R (RS)	346	120	8

Unit: mm

External Dimensions

● BS78-xxxN(NS) (Measuring length : 40/120/170/220/370/420 mm)

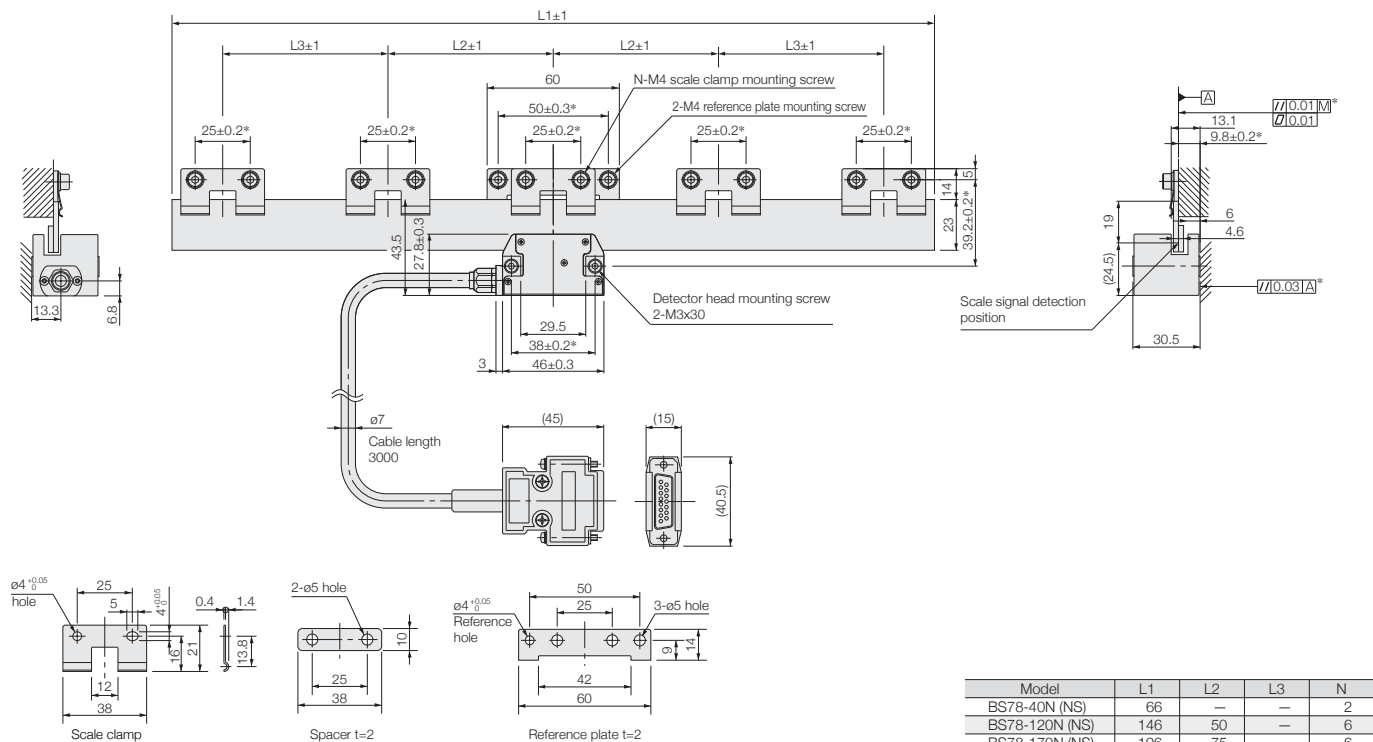

Model	L1	L2	L3	N
BS78-40N (NS)	66	—	—	2
BS78-120N (NS)	146	50	—	6
BS78-170N (NS)	196	75	—	6
BS78-220N (NS)	246	100	—	6
BS78-370N (NS)	396	75	75	10
BS78-420N (NS)	446	100	100	10

Note 1: The items marked by an asterisk indicate the machining dimensions on the mounting surface.  
 Note 2: The surface properties of the scale mounting surface is Rmax = 6.3S.  
 Note 3: The surface properties of the detector head mounting surface is Rmax = 12.5S.  
 Note 4: "M" refers to the machine guide.  
 Note 5: Mount and adjust the paired reference plates so that their reference surfaces have a parallelism of 0.01 or less with respect to the machine guide.

External Dimensions

● BS78-10N/NS (Measuring length : 10 mm)

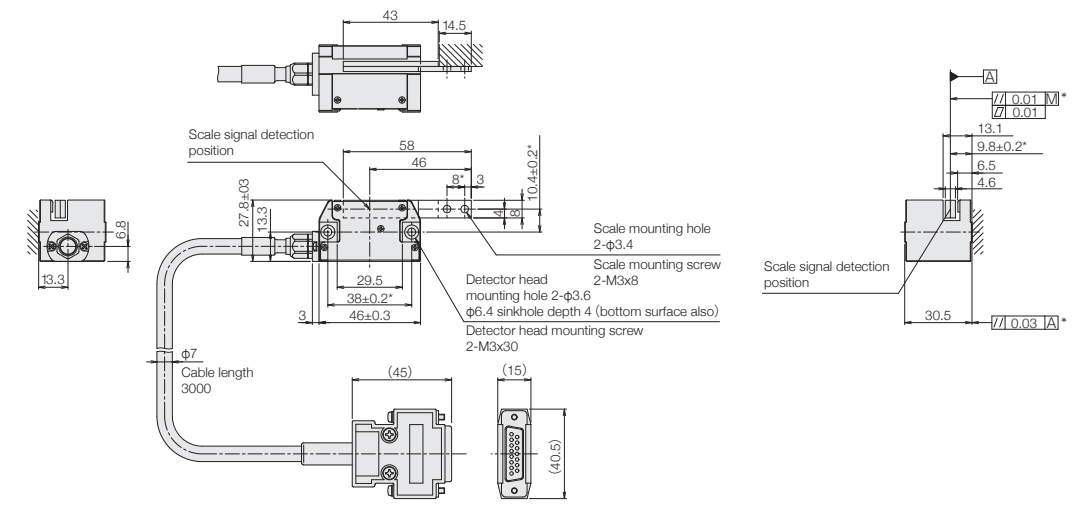

Note 1: The items marked by an asterisk indicate the machining dimensions on the mounting surface.  
 Note 2: The surface properties of the scale mounting surface is Rmax = 6.3S.  
 Note 3: The surface properties of the detector head mounting surface is Rmax = 12.5S.  
 Note 4: "M" refers to the machine guide.  
 Note 5: Mount and adjust the paired reference plates so that their reference surfaces have a parallelism of 0.01 or less with respect to the machine guide.

● BS78-xxxN(NS) (Measuring length : 70/270/320 mm)

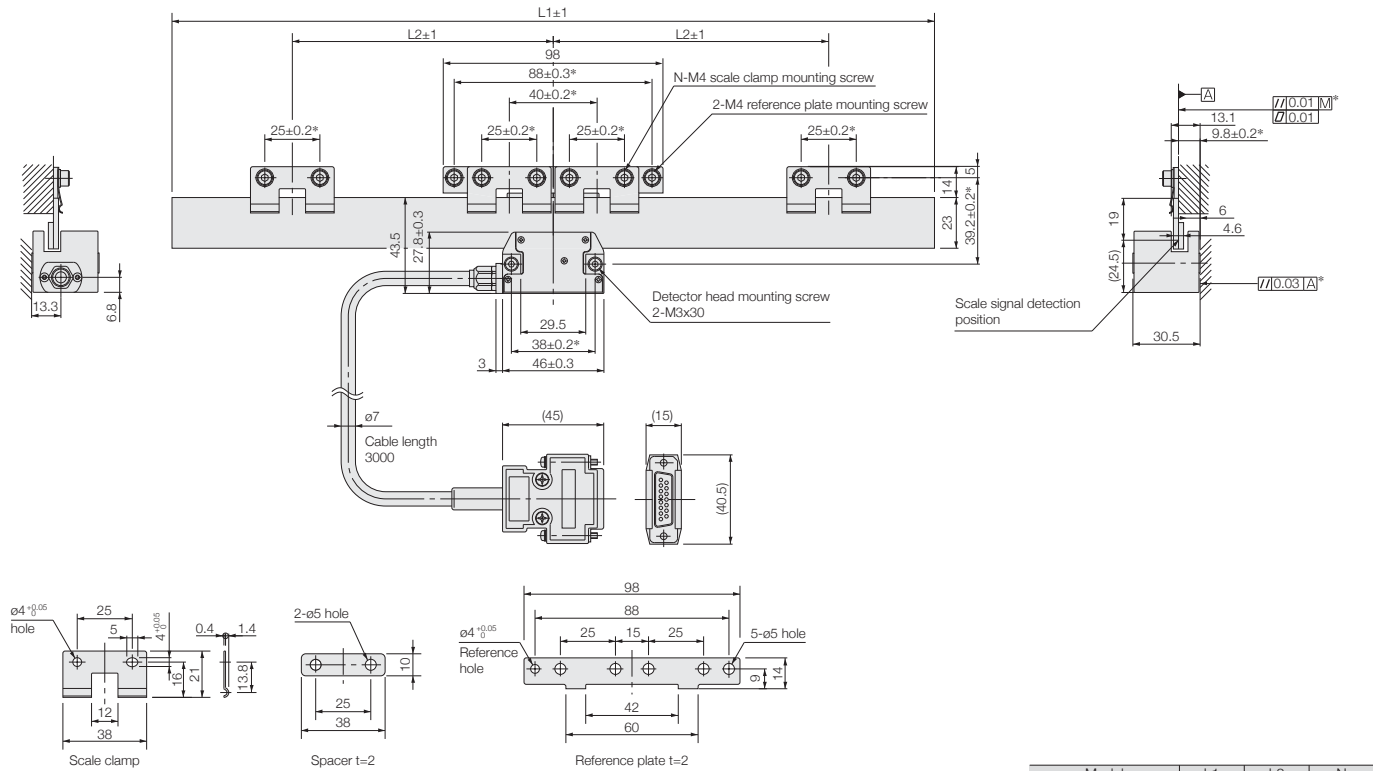

Model	L1	L2	N
BS78-70N (NS)	96	—	4
BS78-270N (NS)	296	120	8
BS78-320N (NS)	346	120	8

Note 1: The items marked by an asterisk indicate the machining dimensions on the mounting surface.  
 Note 2: The surface properties of the scale mounting surface is Rmax = 6.3S.  
 Note 3: The surface properties of the detector head mounting surface is Rmax = 12.5S.  
 Note 4: "M" refers to the machine guide.  
 Note 5: Mount and adjust the paired reference plates so that their reference surfaces have a parallelism of 0.01 or less with respect to the machine guide.

Main Specifications

Model		BS78	
Measuring length	10(only N/NS)/40/70/120/170/220/270/320/370/420 mm		
Overall length	58mm (L=10mm:open type scale), L + 26mm (L= 40mm to 420mm) L: Measuring length		
Max. travel	L + 2mm (L=10mm:open type scale), L + 10mm (L= 40mm to 420mm) L: Measuring length		
Scale accuracy(at20°C)	NS type, RS type : ±0.03µm (L=10mm : NS type) ±0.04µm (L=40mm) ±0.10µm (L=70/120mm) ±0.18µm (L=170/220mm) L: Measuring length	±0.25µm (L=270mm) ±0.34µm (L=320mm) ±0.39µm (L=370mm) ±0.44µm (L=420mm)	N type, R type : ±0.06µm (L=10mm : N type) ±0.08µm (L=40mm) ±0.20µm (L=70/120mm) L: Measuring length
Grating pitch	Approx. 0.55µm		
Signal pitch	Approx. 0.138µm (Approx. 138nm)		
Reference point accuracy	0.1µm (Only R/RS type)		
Reference point position	At the center, and every 50mm from the center to the left and to the right (BS78 models with measuring lengths of 320, 370, 420mm: 20mm offset from the center at 50mm intervals)		
Reference point detection direction	Single direction		
Return error	This is virtually eliminated. It should be considered to be less than two resolution limits of the detector that is used.		
Repeatability	This is virtually eliminated. It should be considered to be less than one resolution limit of the detector that is used.		
Thermal expansion coefficient	-0.7 x 10 <sup>-5</sup> /°C		
Light source	Semiconductor laser : Wavelength 790nm, Output 6mW		
Radiation power	DHHS class 1		
Detection principle	Diffraction grating scanning system		
Operating temperature	10 to 30°C (No condensation)		
Storage temperature	-10 to 50°C (Humidity 60% or less)		
Max. response speed	400mm/s (When connected with BD96)		

Magnescape reserves the right to change product specifications without prior notice.

# BS

## BS65-R (with reference point)

High accuracy Laserscale with built-in optical reference point



Actual size

- Signal pitch of 138nm
- High accuracy, high resolution  
Scale accuracy :  $L < 460 : (0.1+0.4L / 100) \mu\text{m p-p}$   
(L=measuring length in mm)
- High accuracy optical reference point :  $\pm 0.1 \mu\text{m}$
- Measuring length : 160 mm to 960 mm
- Easy installation
- Minimal effect from disrupted air current and atmospheric changes.

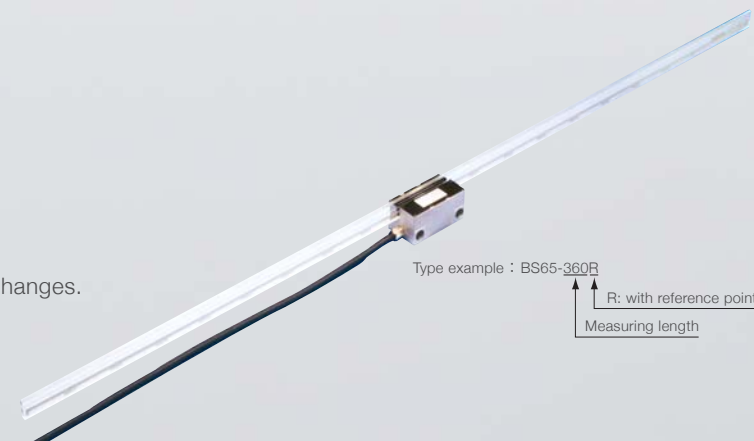

### External Dimensions

#### ● BS65-xxxR (Measuring length : 160/260/360/460/560/660/760/860/960 mm)

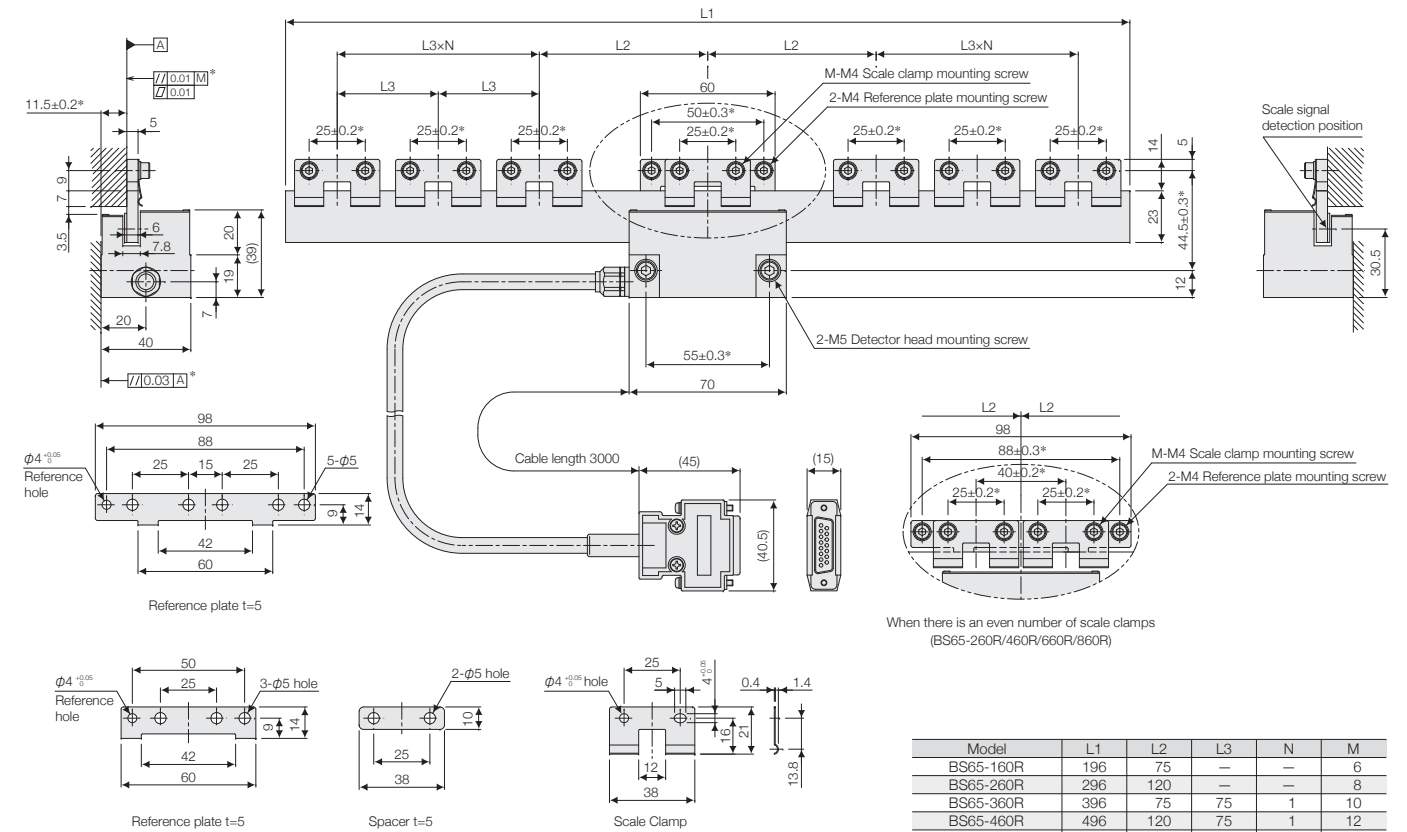

- Note 1: The items marked by an asterisk indicate the machining dimensions on the mounting surface.  
 Note 2: The surface properties of the scale mounting surface is  $R_{\text{max}} = 6.3S$ .  
 Note 3: The surface properties of the detector head mounting surface is  $R_{\text{max}} = 12.5S$ .  
 Note 4: "M" refers to the machine guide.  
 Note 5: Mount and adjust the paired reference plates so that their reference surfaces have a parallelism of 0.01 or less with respect to the machine guide.

Unit: mm

### Main Specifications

Model		BS65-R
Measuring length		160/260/360/460/560/660/760/860/960 mm
Overall length		Measuring length + 36mm
Max. travel		Measuring length + 10mm (5mm on each side)
Scale accuracy (at 20°C)		$L < 460 : (0.1 + 0.4L/100) \mu\text{m p-p}$ $L \geq 460 : 3 \mu\text{m p-p}$ L : Measuring length (mm)
Grating pitch		Approx. $0.55 \mu\text{m}$
Signal pitch		Approx. $0.138 \mu\text{m}$ (Approx. 138nm)
Reference point accuracy		$\pm 0.1 \mu\text{m}$
Reference point position		At the center, and every 50mm from the center to the left and to the right
Reference point detection direction		Single direction
Return error		This is virtually eliminated. It should be considered to be less than two resolution limits of the detector that is used.
Repeatability		This is virtually eliminated. It should be considered to be less than one resolution limit of the detector that is used.
Thermal expansion coefficient		$8 \times 10^{-6} / ^\circ\text{C}$
Light source		Semiconductor laser : Wavelength 790nm, Output 6mW
Radiation power		DHHS class 1
Detection principle		Diffraction grating scanning system
Operating temperature		10 to 30°C (No condensation)
Storage temperature		-10 to 50°C (Humidity less than 60%)
Max. response speed		400mm/s (When connected with BD96)

Magnescape reserves the right to change product specifications without prior notice.



# BH

BH25-RE / BH25-NE  
(with/without reference point)

High-accuracy, reflective Laserscale with signal pitch of 250nm  
Ideal for low-profile stages, semiconductor back-end processing equipment  
and precision microscopes



Actual size

- Signal pitch : 250nm
- High accuracy :  $\pm 1\mu\text{m}/420\text{mm}$
- High response speed : 700mm/s
- Minimum resolution : 0.03125mm
- Available : with/without reference point
- Completely non-contact design : Return error is theoretically eliminated.
- Scale : Soda-lime glass/Low expansion glass
- Thin head with thickness of 12mm
- Supporting various resolutions and output modes (Depending on the interpolator connected.)
- Special vacuum-compatible models available

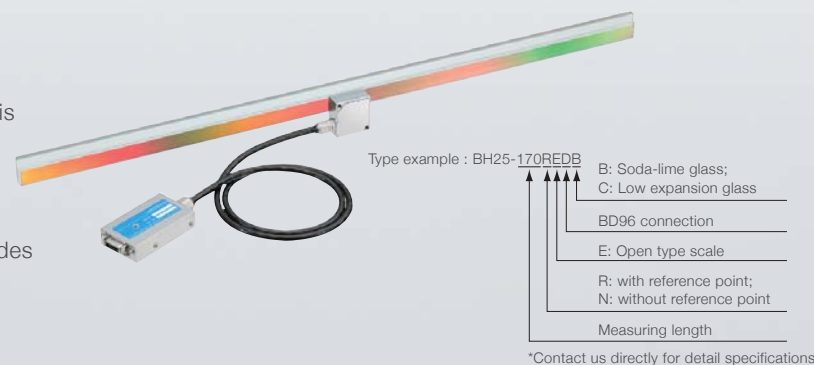

\*Contact us directly for detail specifications

## External Dimensions

### ● BH25-xxxREDB (Measuring length : 30/70/120/170/220/270/320/370/420 mm)

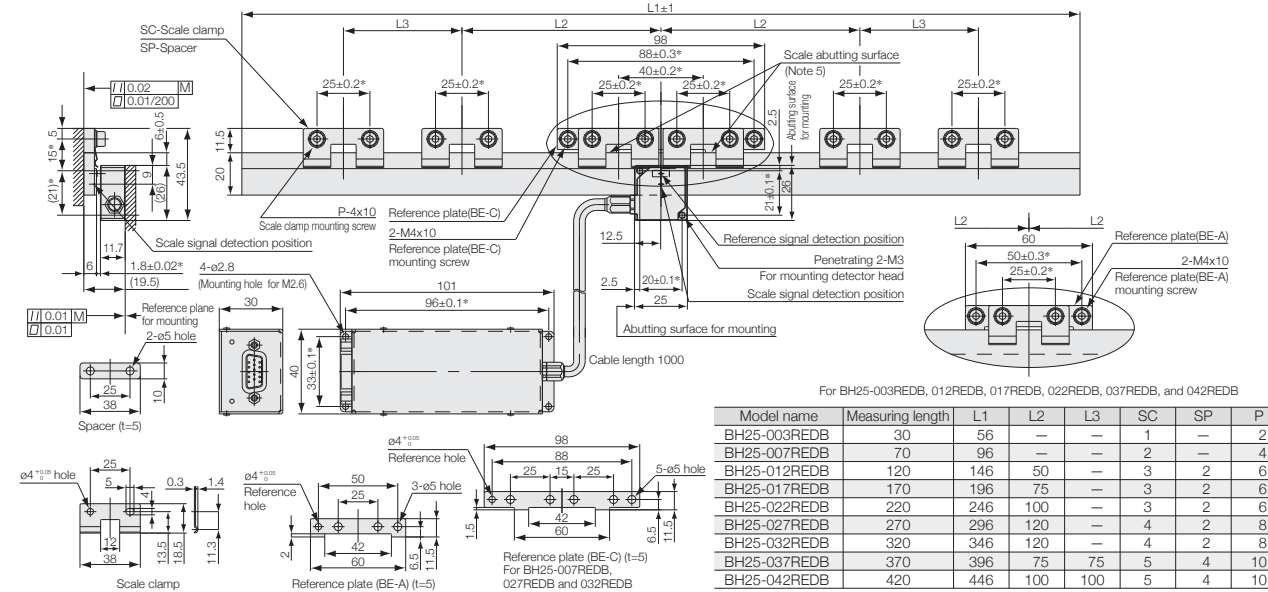

Note 1: The items marked by an asterisk indicate the machining dimensions on the mounting surface. Note 2: The surface properties of the scale mounting surface is  $R_{\text{max}} = 6.3S$ . Note 3: The surface properties of the detector head mounting surface is  $R_{\text{max}} = 6.3S$ . Note 4: \*M refers to the machine guide. Note 5: Mount and adjust the reference plate so that their reference surfaces have a parallelism of 0.01 or less with respect to the machine guide.

### ● BH25-xxxREDC (Measuring length : 30/70/120/170/220/270/320/370/420 mm)

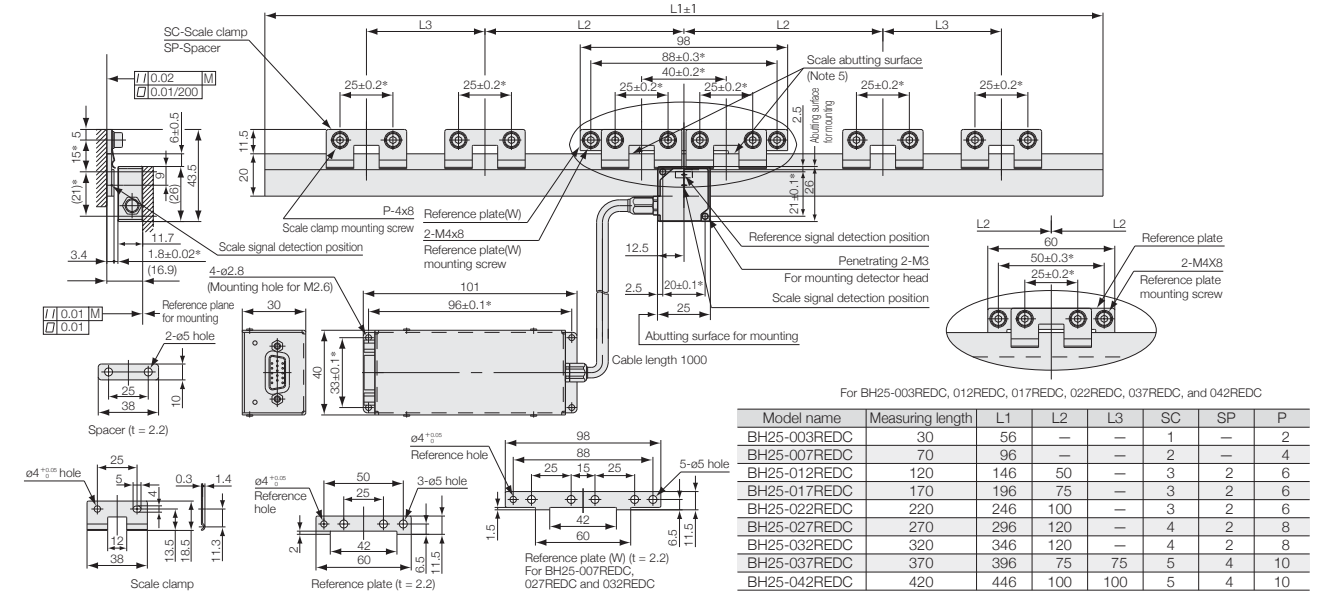

Note 1: The items marked by an asterisk indicate the machining dimensions on the mounting surface. Note 2: The surface properties of the scale mounting surface is  $R_{\text{max}} = 6.3S$ . Note 3: The surface properties of the detector head mounting surface is  $R_{\text{max}} = 6.3S$ . Note 4: \*M refers to the machine guide. Note 5: Mount and adjust the reference plate so that their reference surfaces have a parallelism of 0.01 or less with respect to the machine guide.

## Main Specifications

Model	BH25-RED	BH25-NED
Measuring length	30/70/120/170/220/270/320/370/420 mm (Low expansion glass/Soda-lime glass)	
Overall length	Measuring length +26mm	
Max. travel	Measuring length +10mm	
Scale accuracy (at 20°C)	$\pm 0.5\mu\text{m}$ (30 to 170mm) $\pm 1.0\mu\text{m}$ (220 to 420mm)	
Grating pitch	1.0 $\mu\text{m}$	
Signal pitch	0.25 $\mu\text{m}$ (250nm)	
Reference point	With reference point	None
Reference point detection direction	Single direction	None
Output signal	Interpolator BD96	
Resolution	BD96 connection(Depend on the number of divisions )	
Thermal expansion coefficient	$-0.7 \times 10^{-6}/^\circ\text{C}$ (Low expansion glass) $8 \times 10^{-6}/^\circ\text{C}$ (Soda-lime glass)	
Light source	Semiconductor laser : Wavelength 790nm, Output 6mW	
Detection principle	Diffraction grating scanning system	
Operating temperature	10 to 30°C (No condensation)	
Storage temperature	-10 to 50°C (Humidity less than 60%)	
Max. response speed	700mm/s (When connected with BD96)	

Magnescale reserves the right to change product specifications without prior notice.

# BH

BH20-RE / BH20-NE  
(with/without reference point)

Compact, reflective rotary Laserscale featuring high accuracy, high resolution and high response speed.  
Ideal for high-resolution angle measuring in HDD manufacturing equipment, precision measuring instruments, and aspheric surface processing machines.



- Signal pitch : 250nm
- High response speed : 1,800mm/s (When using analog output), 700mm/s(When connected with BD96)  
160 min<sup>-1</sup> (when using r=41mm scale)  
555 min<sup>-1</sup>(when using r=12mm scale)
- High resolution : 4,194,304,000 pulses/rotation (when using r=41mm scale, divisions=4000)  
3.09 x 10<sup>-4</sup> s  
=1.5nrad
- Available with/without reference point
- Thin head with thickness of 12mm
- Interpolators with various resolutions and output modes available (BD96)
- Special vacuum-compatible models available



Type example: BH20-RED

D: BD96 Connected type  
E: Open type scale  
R: with reference point; N: without reference point  
\*Contact us directly for detail specifications

## External Dimensions

### ● BH20-NED

Straight cable exit

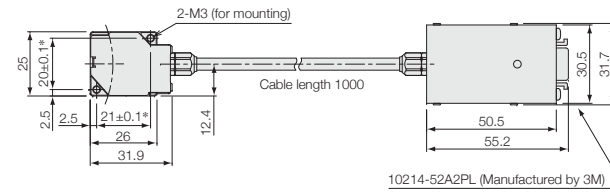

Lateral cable exit

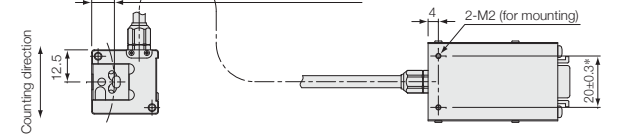
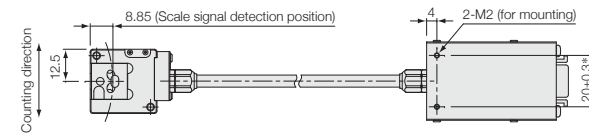
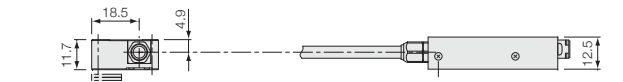
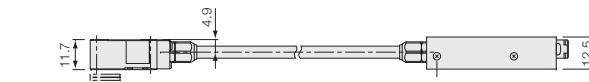
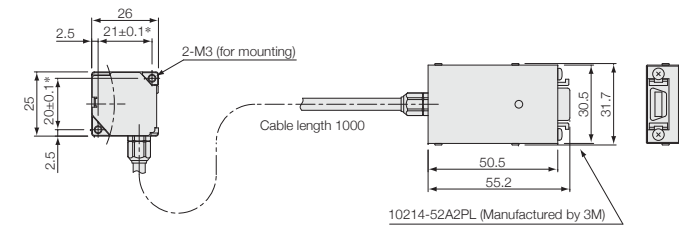

Note: The items marked by an asterisk indicate the machining dimensions on the mounting surface.

Unit: mm

## Main Specifications

Detector head

Model	BH20-RED	BH20-NED
Detection principle	Diffraction grating scanning system	
Light source	Semiconductor laser : Wavelength 790nm, Output 6mW	
Signal pitch	250nm	
Reference point	With reference point	None
Reference point detection direction	Single direction	None
Max. response speed	700mm/s(When connected with BD96)	
Operating temperature	10 to 30°C (No condensation)	
Storage temperature	0 to 50°C (No condensation)	

Signal scale (BE10)

External form	Signal scale (BE10)			
	12.032mm	27.073mm	36.097mm	41.723mm
Detection radius	12.032mm	27.073mm	36.097mm	41.723mm
External form	Internal diameter	8.5mm	37mm	57mm
	External diameter	27mm	60mm	78mm
Grating pitch	1.0μm			
Number of output pulse of one rotation	302,400	680,400	907,200	1,048,576
Max. response speed*(Note1)	1,428 min <sup>-1</sup>	634 min <sup>-1</sup>	476 min <sup>-1</sup>	411 min <sup>-1</sup>

Note 1: When using cable length 1m and Analog output. However, the Max.response speed is limited depending on the cable length.  
Note 2: When the scale and the detector head are purchased separately, signal adjustment is required.  
Magnescale reserves the right to change product specifications without prior notice.

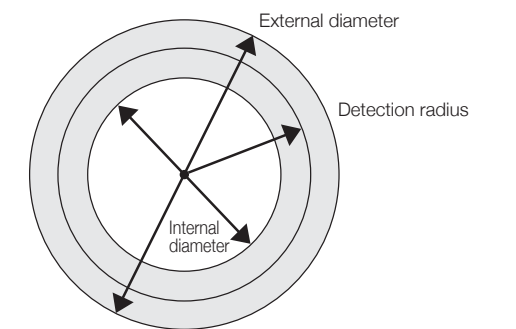

# BL

## BL57-RE / BL57-NE (with/without reference point)

Supports a wide range of applications and offers the highest performance in its class. Ideal for precision stages, semiconductor inspection systems, precision processing machines, and liquid crystal manufacturing equipment.



### BL57-RE

- Achieves a measuring length of up to 1,060mm upon request, and offers the highest-level response speed and accuracy in its class.
  - Signal pitch : 400nm
  - Built-in reference point.
- 〈Applications〉 Precision measuring equipment, precision stages.

### BL57-NE

- Compact size makes machine integration much easier
  - Theoretically unaffected by changes in temperature, humidity, air pressure and air movement. Unparalleled measuring stability achieved by use of low expansion glass
  - Signal pitch : 400nm
- 〈Applications〉 High-accuracy microscopes, measurement equipment.



Type example: BL57-106REFB

B: Soda-lime glass;  
C: Low expansion glass

A: 4-split A/B quadrature output  
F: 4-split 8-split A/B quadrature output  
G: 20-split 40-split A/B quadrature output  
H: Analog 1Vp-p output

E: Open type scale

R: with reference point; N: without reference point

Measuring length

\*Contact us directly for connection with BD96

### External Dimensions

#### ● BL57-xxxRE\*B (Measuring length : 60/160/260/360/460 mm)

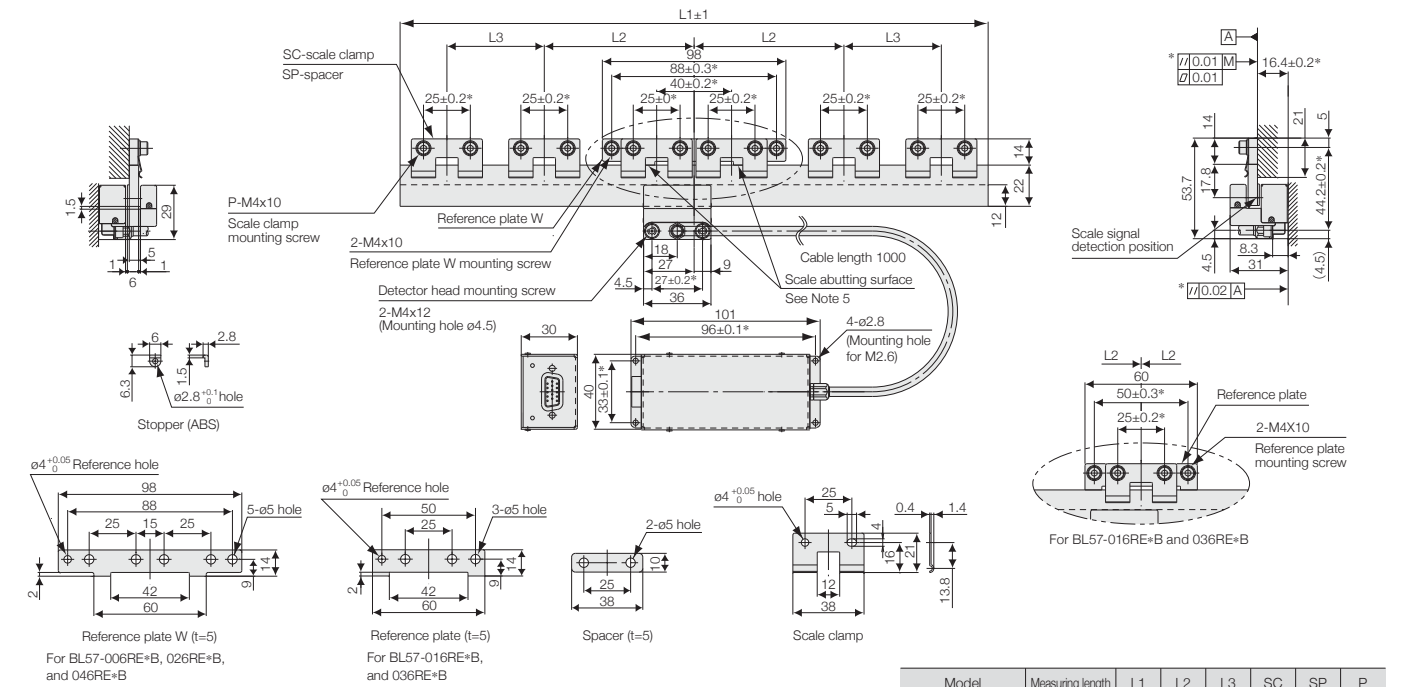

Model	Measuring length	L1	L2	L3	SC	SP	P
BL57-006RE*B	60	96	—	—	2	—	4
BL57-016RE*B	160	196	75	—	3	2	6
BL57-026RE*B	260	296	120	—	4	2	8
BL57-036RE*B	360	396	75	75	5	4	10
BL57-046RE*B	460	496	120	75	6	4	12

Note 1: The items marked by an asterisk indicate the machining dimensions on the mounting surface.  
 Note 2: The surface properties of the scale mounting surface is Rmax = 6.3S.  
 Note 3: The surface properties of the detector head mounting surface is Rmax = 12.5S.  
 Note 4: \*M\* refers to the machine guide.  
 Note 5: When mounting the reference plate (reference plate W), adjust the plate so that the parallelism between the corresponding scale abutting surface and the machine guide is 0.01mm or less.

#### ● BL57-xxxRE\*B (Measuring length : 560/660/760/860/960/1060 mm)

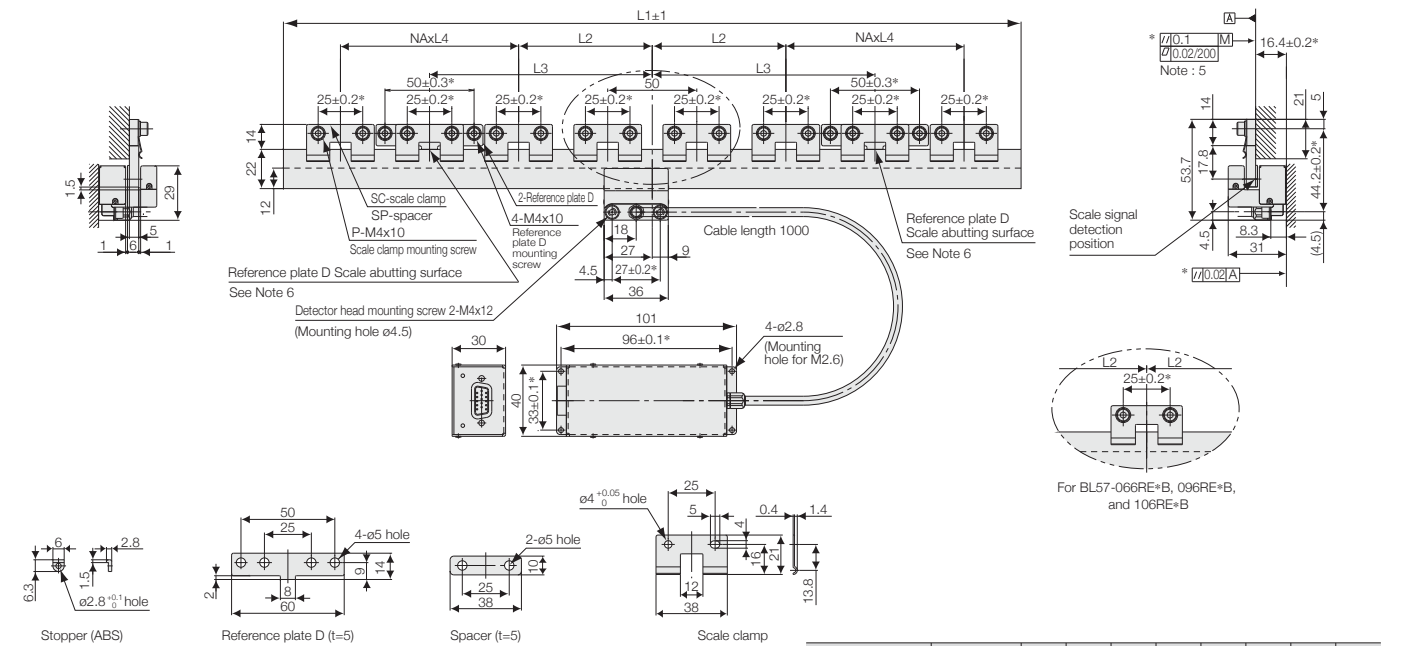

Model	Measuring length	L1	L2	L3	L4	NA	SC	SP	P
BL57-056RE*B	560	596	100	175	75	2	8	6	16
BL57-066RE*B	660	696	75	225	75	3	9	7	18
BL57-076RE*B	760	796	100	250	75	3	10	8	20
BL57-086RE*B	860	896	100	250	75	4	12	10	24
BL57-096RE*B	960	996	75	300	75	5	13	11	26
BL57-106RE*B	1060	1096	75	300	75	6	15	13	30

Note 1: The items marked by an asterisk indicate the machining dimensions on the mounting surface.  
 Note 2: The surface properties of the scale mounting surface is Rmax = 6.3S.  
 Note 3: The surface properties of the detector head mounting surface is Rmax = 12.5S.  
 Note 4: \*M\* refers to the machine guide.  
 Note 5: The flatness of the scale mounting surface must be within 0.02 over the range of 7 (width) x 200 (length) mm.  
 Note 6: Mount and adjust the paired reference plates (D) so that their reference surfaces have a parallelism of 0.1 or less with respect to the machine guide.

External Dimensions

● BL57-xxxRE=C (Measuring length : 30/60/110/160/210/260/310/360/410 mm)

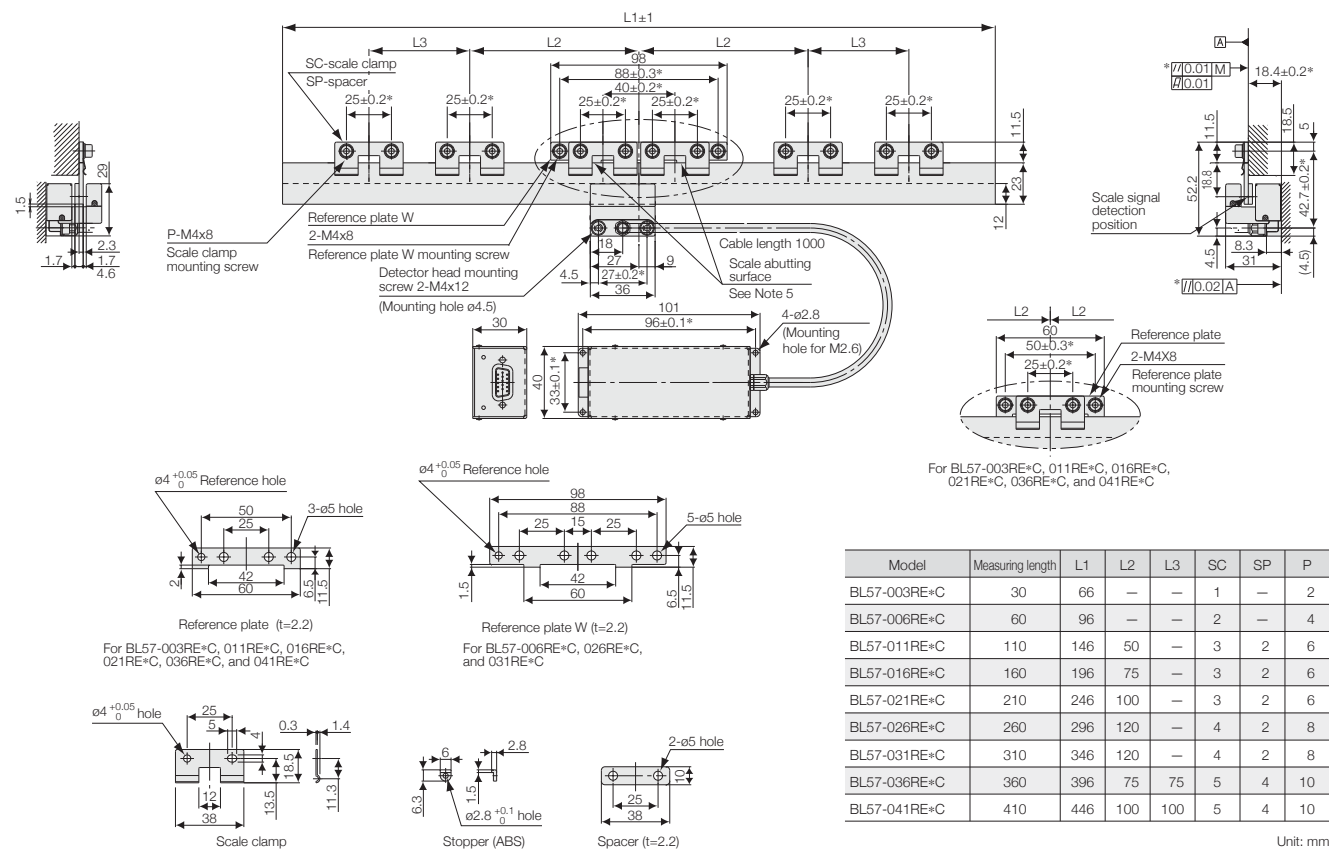

Note 1: The items marked by an asterisk indicate the machining dimensions on the mounting surface. Note 2: The surface properties of the scale mounting surface is Rmax = 6.3S.  
 Note 3: The surface properties of the detector head mounting surface is Rmax = 12.5S. Note 4: "M" refers to the machine guide.  
 Note 5: When mounting the reference plate (reference plate W), adjust the plate so that the parallelism between the corresponding scale abutting surface and the machine guide is 0.01mm or less.

External Dimensions

● BL57-xxxNE=B (Measuring length : 60/160/260/360/460 mm)

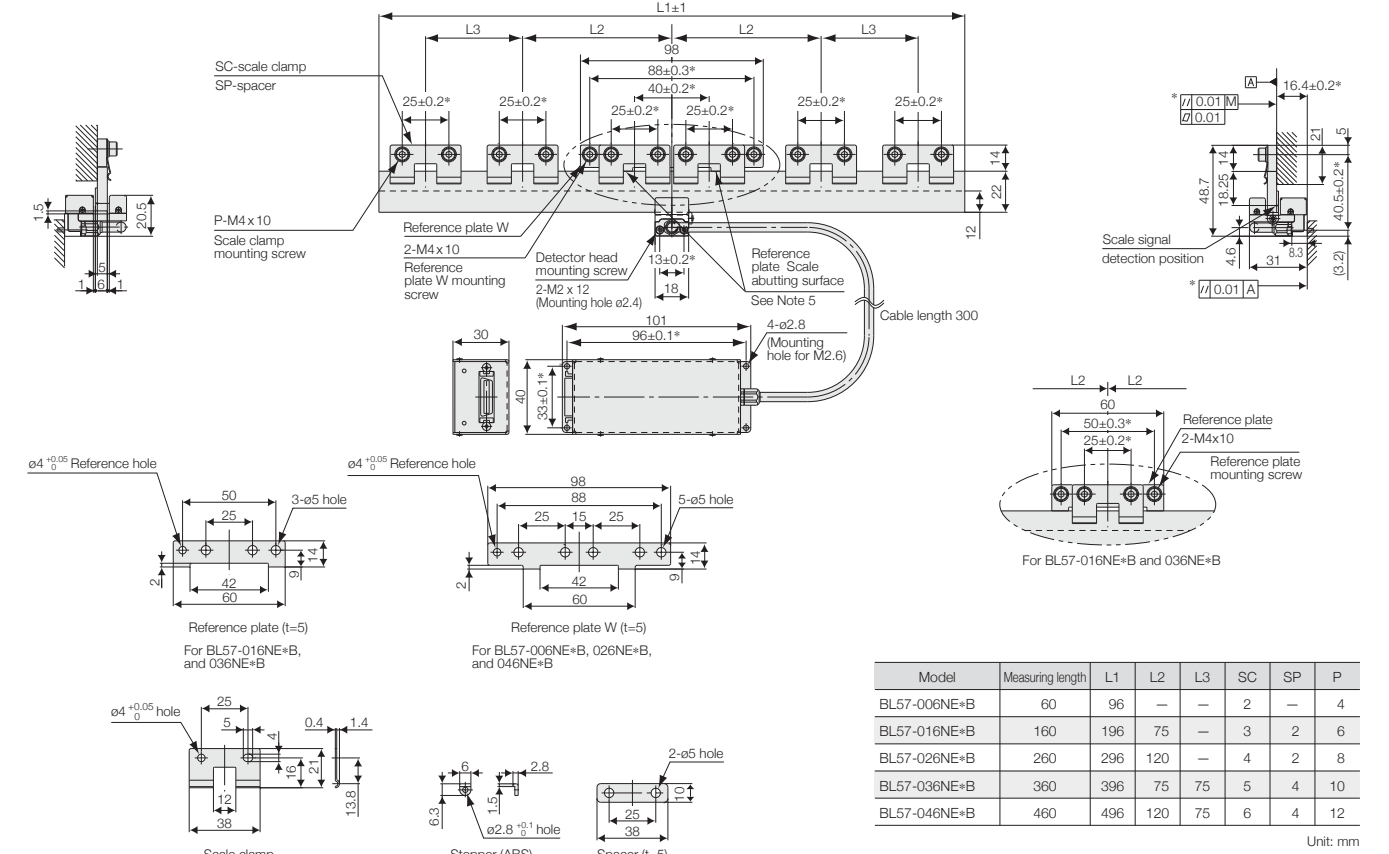

Note 1: The items marked by an asterisk indicate the machining dimensions on the mounting surface. Note 2: The surface properties of the scale mounting surface is Rmax = 6.3S.  
 Note 3: The surface properties of the detector head mounting surface is Rmax = 12.5S. Note 4: "M" refers to the machine guide.  
 Note 5: When mounting the reference plate (reference plate W), adjust the plate so that the parallelism between the corresponding scale abutting surface and the machine guide is 0.01mm or less.

Main Specifications [BL57-RE]

Model	F	G	H
Output signal form	A/B quadrature output		Analog output
Detection principle	Diffraction grating scanning system		
Scale length (Low expansion glass)	Measuring length	30, 60, 110, 160, 210, 260, 310, 360, 410 mm	
	Max. travel	Measuring length + 10mm (5mm on each side)	
	Overall length	Measuring length + 36mm	
Scale length (Soda-lime glass)	Measuring length	60, 160, 260, 360, 460, 560, 660, 760, 860, 960, 1060 mm	
	Max. travel	Measuring length + 10mm (5mm on each side)	
	Overall length	Measuring length + 36mm	
Grating pitch	1.6µm		
Signal pitch	0.4µm (400nm)		
Output signal	Differential (compliant with EIA-422)		Differential (only reference point output are compliant with EIA-422)
	Resolution	0.1/0.05µm (selectable)	0.02/0.01µm (selectable)
Scale accuracy (at 20°C)	±0.5µm(30 to 160mm) / 1.0µm(210 to 360mm) / ±1.5µm(410mm or more)		
Thermal expansion coefficient	Low expansion glass:-0.7x10 <sup>-6</sup> /°C · Soda-lime glass:8x10 <sup>-6</sup> /°C		
Max. response speed	1,500mm/s(0.1µm)	300mm/s(0.02µm)	3,000mm/s
	650mm/s(0.05µm)	120mm/s(0.01µm)	(Note1)
Minimum phase difference:38ns	Minimum phase difference:38ns		Max 7.5MHz

Note 1: Max. response speed become limited by output cable length (the part beyond the interface box).  
 Note 2: A power supply line longer than 10m is incompatible with EN61000-6-2. Take surge protection measures upon use.  
 Note 3: Satisfy the required specifications at the connector input section.  
 Note 4: Special models can support up to 3m. However, the max. response speed is limited depending on the cable length.(In a 3m cable, the max. response speed is two-thirds that of a 1m cable.)  
 Note 5: Special models can support a measuring length of 420mm by low expansion glass and 1,070mm to 1,260mm by soda-lime glass.  
 Magnescale reserves the right to change product specifications without prior notice.

● BL57-xxxNE=B (Measuring length : 560/660/760/860/960/1060 mm)

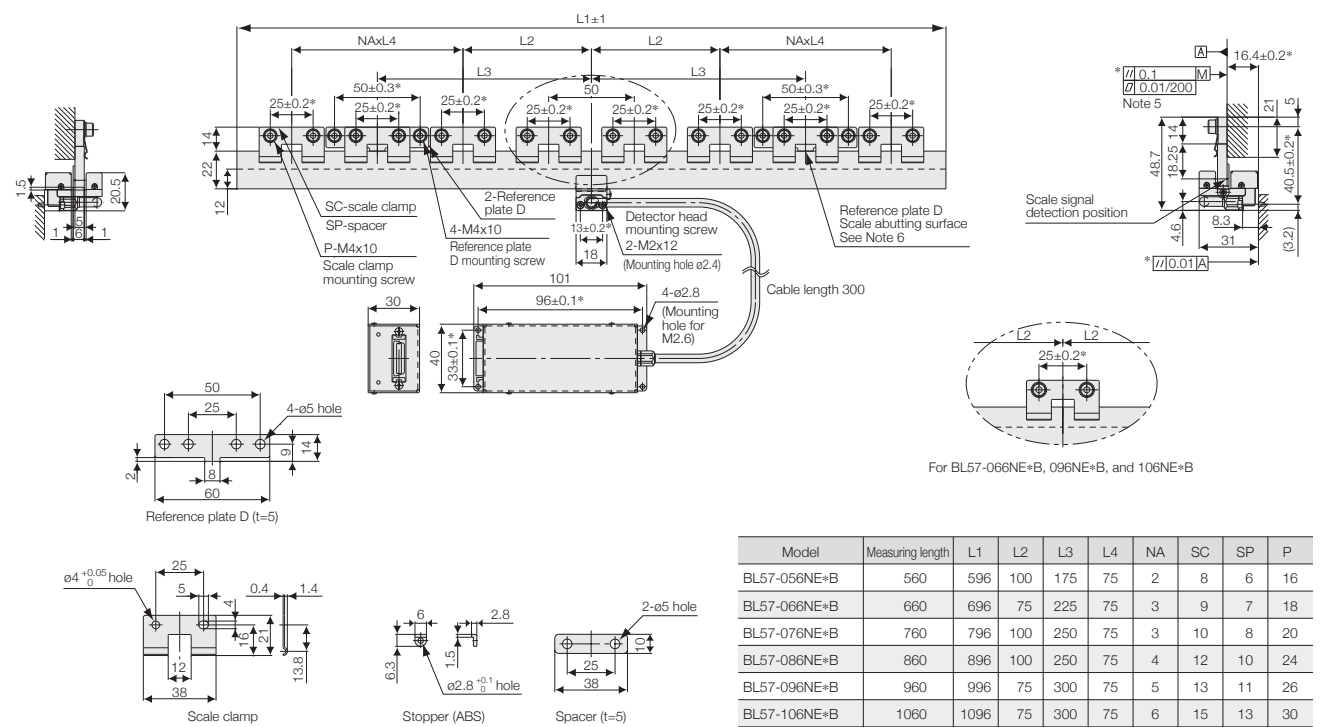

Note 1: The items marked by an asterisk indicate the machining dimensions on the mounting surface. Note 2: The surface properties of the scale mounting surface is Rmax = 6.3S.  
 Note 3: The surface properties of the detector head mounting surface is Rmax = 12.5S. Note 4: "M" refers to the machine guide.  
 Note 5: The flatness of the scale mounting surface must be within 0.02 over the range of 7 (width)x200 (length)mm.  
 Note 6: Mount and adjust the paired reference plates (D) so that their reference surfaces have a parallelism of 0.1 or less with respect to the machine guide.

External Dimensions

● BL57-xxxNE=C (Measuring length : 30/70/120/170/220/270/320/370/420 mm)

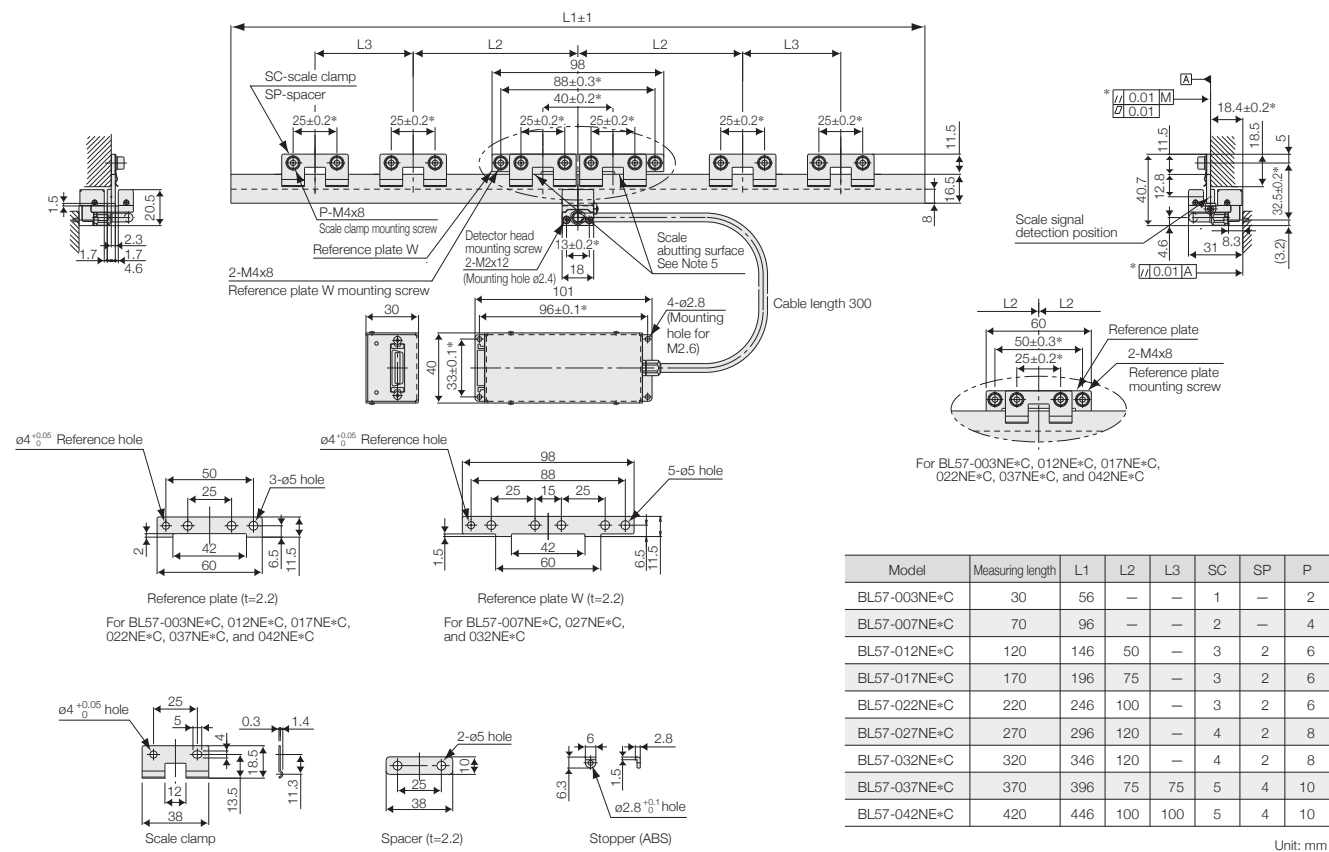

Note 1: The items marked by an asterisk indicate the machining dimensions on the mounting surface. Note 2: The surface properties of the scale mounting surface is Rmax = 6.3S.  
 Note 3: The surface properties of the detector head mounting surface is Rmax = 12.5S. Note 4: "M" refers to the machine guide.  
 Note 5: When mounting the reference plate (reference plate W), adjust the plate so that the parallelism between the corresponding scale abutting surface and the machine guide is 0.01mm or less.

Main Specifications[BL57-NE]				
Model	A	F	G	H
Output signal form	A/B quadrature output			Analog output
Detection principle	Diffraction grating scanning system			
Scale length (Low expansion glass)	Measuring length	30, 70, 120, 170, 220, 270, 320, 370, 420 mm		
	Max. travel	Measuring length + 10mm (5mm on each side)		
	Overall length	Measuring length + 26mm		
Scale length (Soda-lime glass)	Measuring length	60, 160, 260, 360, 460, 560, 660, 760, 860, 960, 1060 mm		
	Max. travel	Measuring length + 10mm (5mm on each side)		
	Overall length	Measuring length + 36mm		
Grating pitch	1.6µm			
Signal pitch	0.4µm (400nm)			
Output signal	Differential (compliant with EIA-422)			Differential
Resolution	0.1µm	0.1/0.05µm (selectable)	0.02/0.01µm (selectable)	0.4µm (1Vp-p)
Scale accuracy (at 20°C)	±0.5µm (30 to 170mm)/ 1.0µm (220 to 370mm)/ ±1.5µm (420mm or more)			
Thermal expansion coefficient	Low expansion glass: -0.7 x 10 <sup>-6</sup> /°C · Soda-lime glass: 8 x 10 <sup>-6</sup> /°C			
Max. response speed	1,000mm/s	1,500mm/s (0.1µm) 650mm/s (0.05µm)	300mm/s (0.02µm) 120mm/s (0.01µm)	3,000mm/s (Note 1)
	Minimum phase difference: 80ns	Minimum phase difference: 38ns	Minimum phase difference: 38ns	Max 7.5MHz

Note 1: Max. response speed become limited by output cable length (the part beyond the interface box).  
 Note 2: A power supply line longer than 10m is incompatible with EN61000-6-2. Take surge protection measures upon use.  
 Note 3: Satisfy the required specifications at the connector input section.  
 Magnescale reserves the right to change product specifications without prior notice.

BL57-RE supporting vacuum environment (Special models)

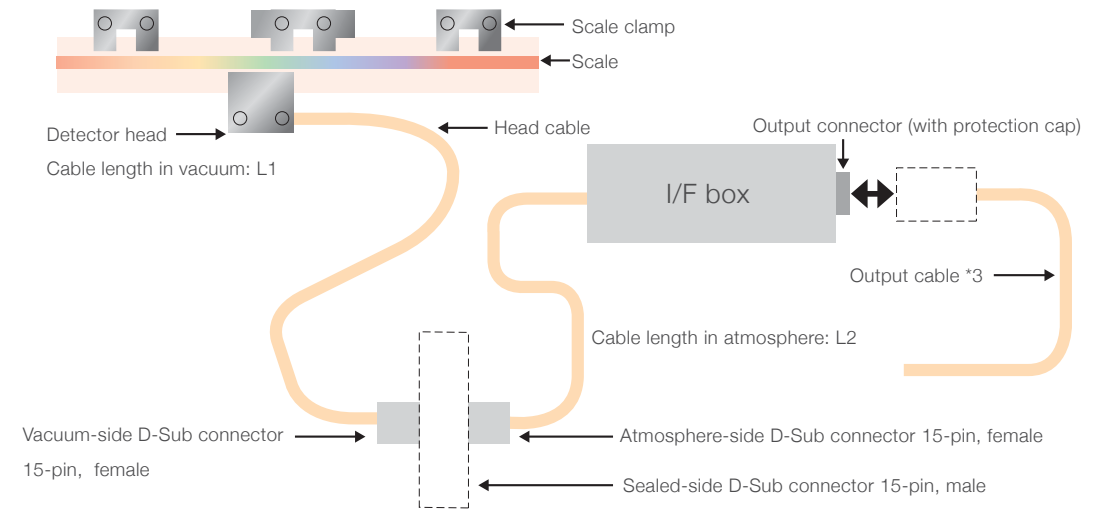

Vacuum-compatible, open type with reference point. Allowing ultra-precise positioning in a vacuum environment.

- Ultimate vacuum of 10<sup>-5</sup> Pa class.
- Emitted gas flow rate of 10<sup>-6</sup> Pa · m<sup>3</sup> class.
- Signal pitch 0.4µm
- Built-in reference point.

Applications: Semiconductor inspection systems, length measuring SEM.

\*1: For dimensions of head, scale, and I/F box, see the page on BL57-RE. \*2: Cable length in vacuum and in atmosphere (L1 + L2) is up to 3m.  
 \*3: Output cable is not included in the product.

Outgas analysis chart

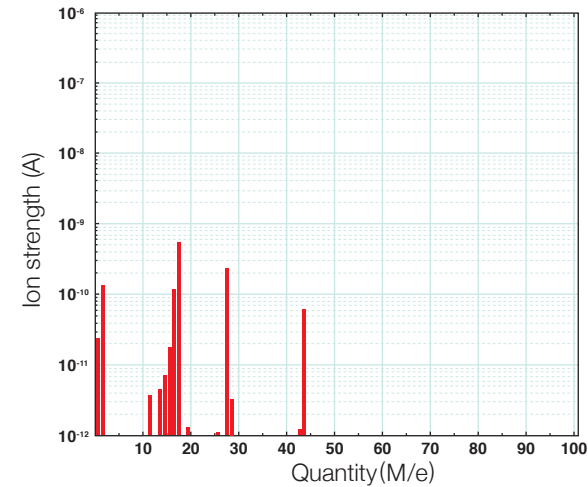

# BD

## BD96 Interpolator for Laserscale

Minimum resolution of 17pm when combined with the BS series.  
Supporting various serial and binary outputs.

### External Dimensions

● BD96-B1,B2,Y1,Y2, M1, M2 commonness

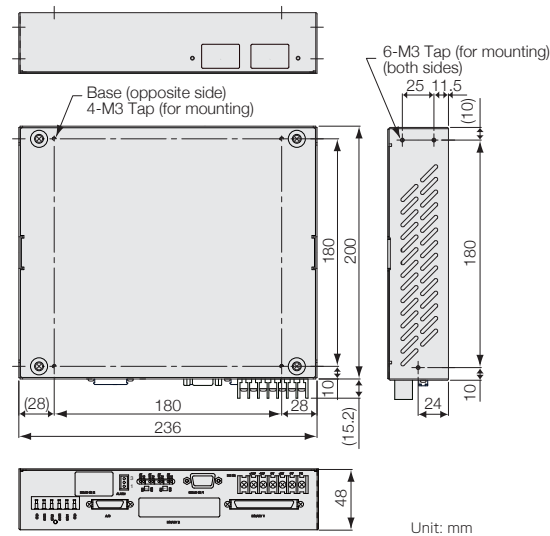

- Minimum resolution :  
0.4nm (When connected with BL series)  
31pm (When connected with BH series)  
17pm (When connected with BS series)
- High response speed :  
1,100mm/s (When connected with BL series)  
700mm/s (When connected with BH series)  
400mm/s (When connected with BS series)
- Various serial or binary outputs
- Includes automatic signal compensation
- A/B quadrature output (standard : 4 divisions) (binary output axis 1 or 2 type)  
BS series : 34.5nm, BH series : 62.5nm, BL series : 100nm
- Max. divisions : 8000 (When connected with BS and BH series) (special model)

\* Please inquire about various specifications, such as the number of divisions.

Main Specifications	
Model	BD96
Resolution	17pm (When connected with BS series), 31.25pm (When connected with BH series), 0.4nm (When connected with BL series)
Max. response speed	400mm/s (When connected with BS series), 700mm/s (When connected with BH series), 1,100mm/s (When connected with BL series)
Max. divisions	025 : 256, 051 : 512, 040 : 400, 050 : 500, 100 : 1000, 200 : 2000, 400 : 4000 (special model 800 : 8000 divisions)
Alarm	When exceeding the max. response speed or when the laser signal level is too low (disconnection); LED lights up
Input signal compensation	DC offset, amplitude, phase
Power supply	DC +5V±5% DC +12V±5% DC -12V±5%
Power consumption (When connected with scale)	DC +5V : 0.4A DC +12V : 0.4A DC -12V : 0.2A ( 1 axes type ) DC +5V : 0.4A DC +12V : 0.7A DC -12V : 0.5A ( 2 axes type )
Operating temperature	0 to +40°C
Storage temperature	-10 to +50°C
Dimensions	236 (W) x 215.2 (D) x 48 (H)mm
Mass	Approx. 1.6kg

BD96-☆△\*\*□C  
 ↑ Shape C: Case type  
 ↑ Scale type S: BS series H: BH series L: BL series  
 ↑ Division 025: 256 divisions 051: 512 divisions 040: 400 divisions 050: 500 divisions 100: 1000 divisions 200: 2000 divisions 400: 4000 divisions  
 ↑ Axis type 1: 1 axis 2: 2 axes  
 ↑ Output mode B: Binary (Axis type 1 : 40 bits, 2 : 20bits) Y: Yaskawa Electric serial \*1 M: Mitsubishi Electric serial F: FANUC serial \*2

\*1 Only supported with 256 and 512 division \*2 Special model  
Magnescale reserves the right to change product specifications without prior notice.



# BD

## BD95 Interpolator for BS series Laserscale

Interpolator with A/B quadrature output that achieves resolution from 4.3nm~34.5nm.

### External Dimensions

● BD95-T10,T13,T14,T15,T16,T17 commonness

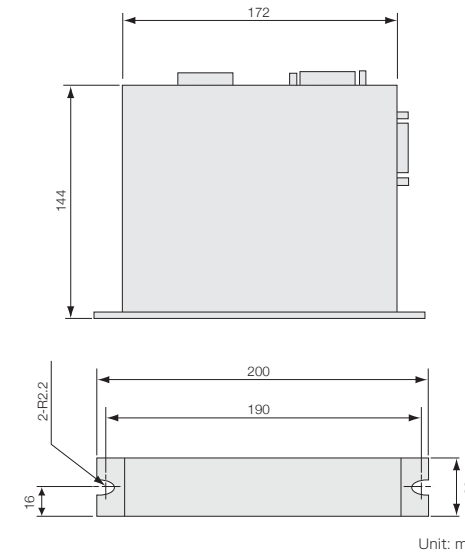

- High resolution: 4.3 to 34.5nm (depends on the number of divisions)
- High response speed: 400mm/s
- DC offset, gain, phase automatic conditioning
- 32 bit binary output by data request input (T14, T16, T17)

Main Specifications						
Model	BD95-T13	BD95-T14	BD95-T15	BD95-T16	BD95-T10	BD95-T17
Resolution	34.5 nm (4 divisions) or 17.2nm (8 divisions) 100 nm or 50 nm during pitch compensation	17.2 nm (8 divisions) or 8.6 nm (16 divisions) 100 nm, 50 nm, or 10 nm during pitch compensation	17.2 nm (8 divisions) or 8.6 nm (16 divisions) 100 nm, 50 nm, or 10 nm during pitch compensation	100 nm, 50 nm, 10 nm or 5 nm during pitch compensation	8.6 nm (16 divisions) or 4.3 nm (32 divisions) 100 nm, 50nm, 10 nm or 5 nm during pitch compensation	8.6 nm (16 divisions) or 4.3 nm (32 divisions) 100 nm, 50nm, 10 nm or 5 nm during pitch compensation
Max. response speed	400 mm/s (with 4 divisions) 275 mm/s (with 8 divisions)	275 mm/s (with 8 divisions)	275 mm/s (with 8 divisions)	120 mm/s (with 16 divisions)	120 mm/s (with 16 divisions)	60 mm/s (with 32 divisions)
Output signal	A/B quadrature 1 with / without pitch compensation (compliant with EIA-422) A/B quadrature 2 without pitch compensation (compliant with EIA-422) Reference point (compliant with EIA-422) Alarm (compliant with EIA-422) (Switching between automatic reset and holding is possible) Laserscale signal (SIN/COS) 32-bit binary data (-T14, -T16, -T17 only)					
Alarm	When exceeding the max. response speed or when the laser signal level is too low (disconnection); LED lights up					
Pitch compensation function	A/B quadrature 1 only A round-off error of 1 resolution occurs.					
Power supply	DC + 24V±1V					
Power consumption (when connected with scale)	400mA (maximum)					
Operating temperature	0 to 50°C					
Storage temperature	-10 to 60°C					
Dimensions	172 (W)x144(D)x32(H) mm					
Mass	Approx. 0.8 kg					

Magnescale reserves the right to change product specifications without prior notice.

# Connection Cable

Scales		Extension Cable*2	Interpolator
Model	Head cable length*1		
BS78 BS65-R	3m (Standard)	Robot cable:CK-T133 (0.1m) CK-T137 (3.0m) CK-T167 (4.0m) CK-T112 (5.0m) CK-T132 (8.0m) CK-T159 (9.0m)	
BH25-NE BH20-NE	1m (Standard)	Robot cable:CK-T148 (3.0m)	BD96
BH25-RED BH20-RED BL57-RED	1m (Standard)	Robot cable:CE20-01T01 (1.0m) CE20-02T02 (2.0m) CE20-03T10 (3.0m) CE20-04T01 (4.0m) CE20-05T08 (5.0m) CE20-06T01 (6.0m) CK-T144 (9.0m)	

\*1 Please contact sales for additional lengths. \*2 Available up to 9 meters (BS series). For cables longer than 9 meters, please contact sales.

Scales		Extension Cable	Interpolator
Model	Head cable length*1		
BS78 BS65-R	3m (Standard)	Robot cable:CK-T41 (0.3m) CK-T67 (1.0m) CK-T199 (2.0m) CK-T24 (3.0m) CK-T168 (4.0m) CK-T54 (6.0m) CK-T106 (8.0m)	BD95

Scales		Extension Cable	Interpolator
Model	Head cable length*1		
BL57-NE (A/B quadrature)	0.3m (Standard)	Robot cable:CE20-03T07 (3.0m) CE20-05T05 (5.0m) CE20-10T02 (10.0m)	Built-in I/F Box
BL57-RE (A/B quadrature)	1m (Standard)		
BL57-NE (Analog)	0.3m (Standard)	Robot cable:CE20-03T12 (3.0m) CE20-07T03 (7.0m)	None
BL57-RE (Analog)	1m (Standard)	CE20-12T01 (12.0m)	

\*1 Please ask for other length.

The robot cable minimum bending radius: R80mm is fixed repeatedly R10mm.

# Technology

## Reference point detection direction

The optical built-in reference point of the laserscale can be detected by single direction.

Forward detection is set as standard, but it can detect signal from reverse direction depending on the equipment in use. The direction should be specified before order.

Please contact us for further information.

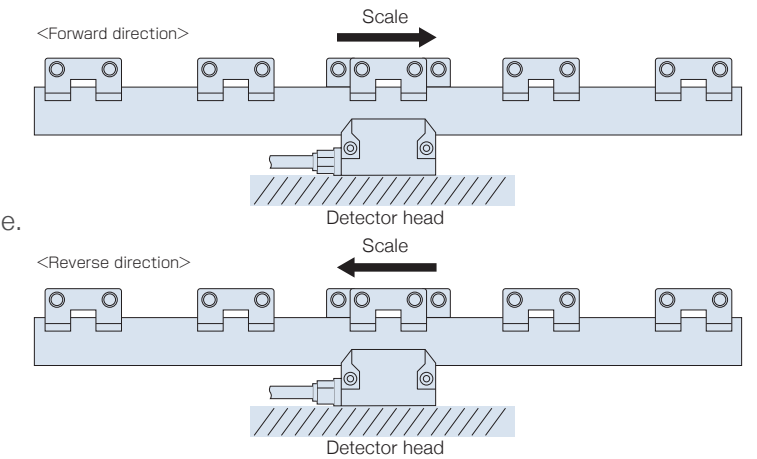

\* Do not detect the reference point from the wrong direction in order to keep the reliability of the reference point and to avoid deterioration.

## Scale Signal Output

### A/B quadrature and Alarm Output Specifications (For output formats F and G) BL57

- The output specifications are compliant with EIA-422.
- A/B quadrature minimum phase difference  $t$ : 38 ns (BL57)

[Note]

- An error of about 38 ns is generated due to the synchronization of the A/B quadrature by the 26.3 MHz internal clock.
- The minimum phase difference can vary depending on the length of the output cable, cable capacity, receiver load, and other factors.

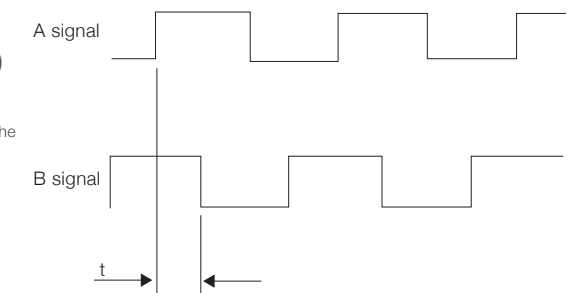

## Connection Specifications

### A/B quadrature Output Type

The line driver used by Magnescale Co., Ltd. is compliant with EIA-422.

Also, based on the EIA-422 standards, the common mode voltage between the line driver and line receiver is stipulated as  $\pm 12$  V.

(Using the scale when the common mode voltage of  $\pm 12$  V is exceeded can damage the scale.)

To prevent problems between the control devices connected to this Magnescale Co., Ltd. product, it is recommended that you connect (shared connection) the signal ground (power supply ground) and set the load resistance to 120  $\Omega$ .

Twisted pair cables (1 turn/1 inch min.) with a

core thickness of at least AWG28 are recommended for the differential signal cables.

(It is even better if the characteristic differential impedance is the same as the load resistance value.)

### <Commonness>

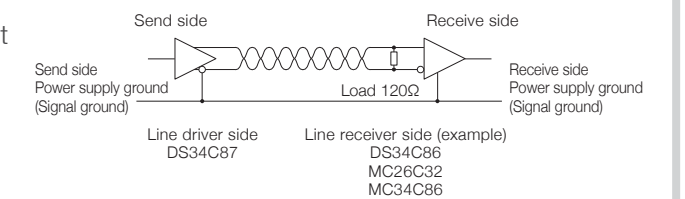

### <BL57>

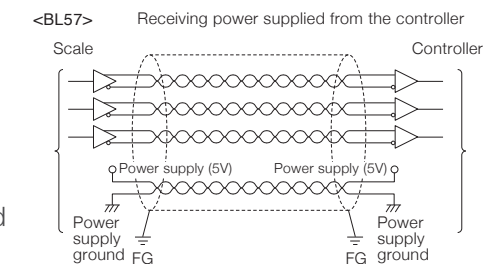

## Analog Output Specifications BL57

### SIN/COS output specifications (For output format H)

(Over the overall length and the entire operating temperature range)

Item	Symbol	Specifications			Units	Remarks
		Min.	Typ.	Max.		
Output signal amplitude	$(+VA) - (-VA), (+VB) - (-VB)$	0.6	1	1.2	Vp-p	Note 1
Output signal phase difference		80	90	100	deg	
Center voltage	$+VOA, +VOB, -VOA, -VOB$	2.3	2.5	2.7	V	
Offset voltage	$(+VOA) - (-VOA), (+VOB) - (-VOB)$	-50	0	50	mV	
Gain unbalance		-6	0	6	%	System 1
Load resistance			120		$\Omega$	

Note 1: When terminator  $Z0 = 120\Omega$  supply voltage =  $5V \pm 5\%$   
(voltage of load resistance at both ends)

System 1:  $\frac{A \text{ signal output voltage p-p value} - A/B \text{ quadrature output average}}{A/B \text{ quadrature output average}} \times 100$

where

A/B quadrature output average

$$= \frac{A \text{ signal output voltage p-p value} + B \text{ signal output voltage p-p value}}{2}$$

### Output waveform diagram

(When each output is viewed based on 0 V)

The A signal corresponds to SIN,  
and the B signal corresponds to COS.

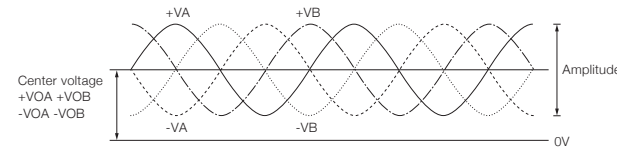

### Connection Specification

Example of input circuit

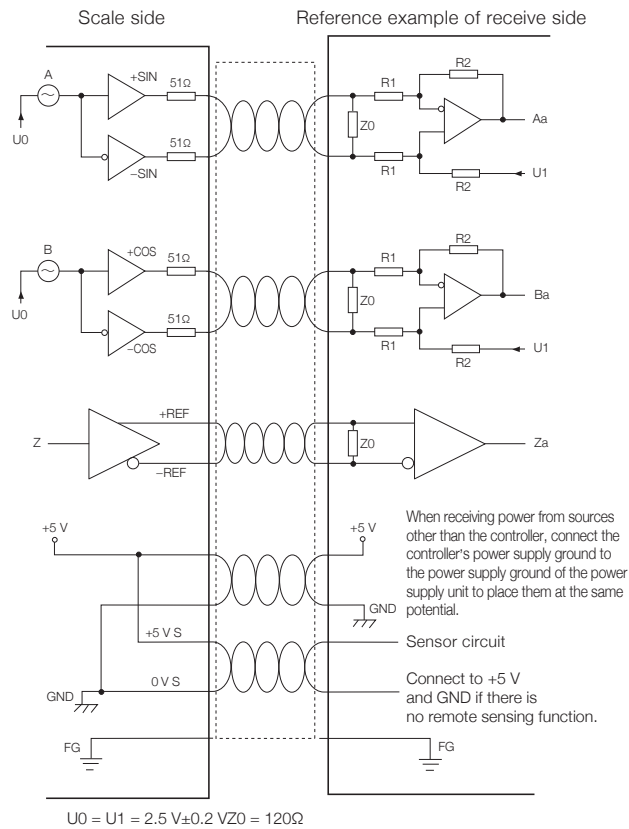

Recommended elements

SIN and COS : Differential receiver LMH6654

$R1 = R2 = 10 \text{ k}\Omega$

REF : DS34C86

### Reference point output specifications

The output specifications are compliant with EIA-422.

(Over the overall length and the entire operating temperature range)

Item	Symbol	Specifications			Units
		Min.	Typ.	Max.	
"H" level output	$VoZH$	2.5	3.4	5	V
"L" level output	$VoZL$	0	0.3	0.5	V

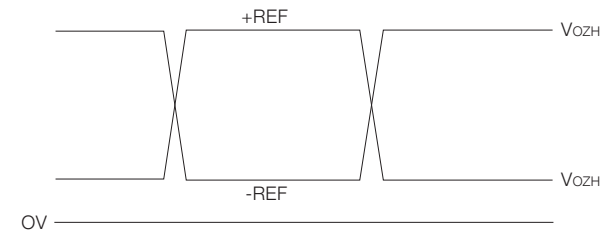

Reference point signal and SIN and COS signal phases

Item	Specifications		
	Min.	Typ.	Max.
Reference point signal width (Lz)	0.32 $\mu\text{m}$	0.4 $\mu\text{m}$	0.48 $\mu\text{m}$
Position of reference point signal edge a with respect to SIN signal	0°		90°

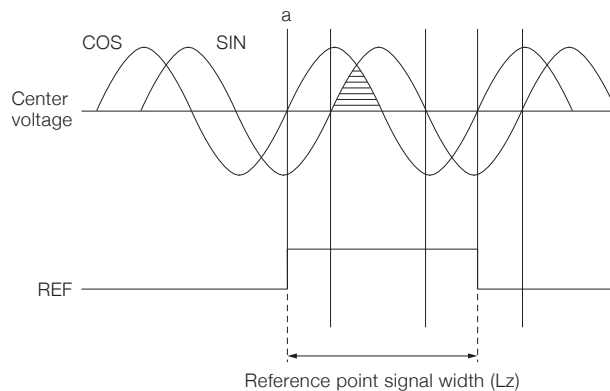

## Input/Output Connectors

### Connectors (Open type) BL57

Pin arrangement	Input/output specifications	
	A/B quadrature output (Output format F, G)	Analog output (Output format H)
1	A	+COS
2	*A	-COS
3	B	+SIN
4	*B	-SIN
5	REF	(Not connectable)
6	*REF	0 V (power supply)
7	+5 V (power supply)	0VS
8	ALM	(Not connectable)
9	+5 V (power supply)	+5 V (power supply)
10	*ALM	+5VS
11	+5VS	+REF
12	(Not connectable)	-REF
13	+5 V (power supply)	(Not connectable)
14	SIN (M)	(Not connectable)
15	0 V (power supply)	(Not connectable)
16	COS (M)	
17	0 V (power supply)	
18	(Not connectable)	
19	0VS	
20	(Not connectable)	
21	0V (M)	
22	(Not connectable)	
23	0 V (power supply)	
24	(Not connectable)	
25	0 V (signal)	
26	(Not connectable)	

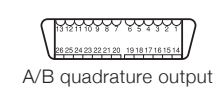

Interface unit side:

A/B quadrature output : 10226-52A2PL

(manufactured by 3M Japan Limited)

Analog output : D02-M15SAG-26L9E

(manufactured by Japan Aviation Electronics Industry, Limited)

Cable side:

A/B quadrature output : Plug 10126-3000PE

(manufactured by 3M Japan Limited)

Shell 10326-52F0-00S

(manufactured by 3M Japan Limited)

Analog output : Plug D02-M15PG-N-F0

(manufactured by Japan Aviation Electronics Industry, Limited)

Contact When AWG24 wire is used

D02-22-22P-PKG100

(manufactured by Japan Aviation Electronics Industry, Limited)

Contact When AWG26-28 wire is used

D02-22-26P-PKG100

(manufactured by Japan Aviation Electronics Industry, Limited)

Shell DE-C8-J9-F2-1R

(manufactured by Japan Aviation Electronics Industry, Limited)