

PCST21 POSICHRON[®] Position Sensor

Stick Design with Analog Output



POSICHRON[®] position sensor in stick design

- Protection class IP67
- Measurement range 0 ... 100 up to 0 ... 5750 mm
- Absolute position measurement
- For applications in hydraulic cylinders
- Easy mounting
- Wear- and maintenance free
- 0 ... 10 V output
- 4 ... 20 mA output

Discontinued model
Don't use for further developments
Replaced by PCST24

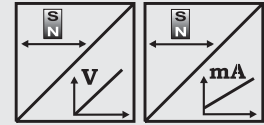

Specifications		
Output	Voltage: 0 ... 10 V, 3 wire	Current: 4 ... 20 mA, 3 wire
Resolution	Essentially infinite	
Sampling rate	0.5 ... 2 kHz depending on measurement range	
Linearity	±0.1 mm for ranges ≤500 mm ±0.02 % f.s. for ranges >500 mm	
Housing material	Stainless steel 1.4401	
Mounting	Thread M18 x 1,5	
Operating pressure	300 bar, other values on request	
Protection class	IP67 (connector output: with mating connector)	
Operating temperature	-40 ... +85 °C	
EMC, immunity to interference	EN61326: 1998, Table A1	
EMC, radio frequency emission	EN55011 group 1 class A	
Shock	100 g/6 ms according to EN60068-2-27	
Vibration	15 g, 10 ... 2000 Hz according to EN60068-2-6	
Connection	Male socket 8 pin DIN 45326/cable 3 m (standard)	

Order Code PCST21

Model Name PCST21 - - -

Measurement Range (in mm)
100 / 500 / 1000 / 1500 / 2000 / 2500 / 3000 / 4000 / 5000 / 5750
Other ranges on request

Outputs
10V = with 0 ... 10 V signal conditioner (3 wire)
420T = with 4 ... 20 mA signal conditioner (3 wire)

Connection
D8 = Connector 8 pin DIN 45326
KAB3M = Cable output, standard length 3 m

Order Code Mating Connector (see accessories page 63)

WS-CONN-D8

Order Code Position Magnet (see accessories page 59)

PCSTMAG...

Order Example: PCST21 - 1500 - 10V - D8

PCST21 POSICHRON[®] Position Sensor Stick Design with Pulse Output



POSICHRON[®] position sensor in stick design

- Protection class IP67
- Measurement range 0 ... 100 up to 0 ... 5750 mm
- Absolute position measurement
- For applications in hydraulic cylinders
- Easy mounting
- Wear- and maintenance-free
- Pulse output (start/stop)

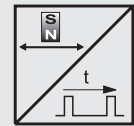

Specifications		
Output		Pulse output (start/stop)
Resolution		Essentially infinite
Sampling rate		0.5 ... 2 kHz depending on measurement range
Linearity		±0.1 mm for ranges ≤500 mm ±0.02 % f.s. for ranges >500 mm
Housing material		Stainless steel 1.4401
Mounting		Thread M18 x 1,5
Operating pressure		300 bar, other values on request
Protection class		IP67 (connector output: with mating connector)
Operating temperature		-40 ... +85 °C
EMC, immunity to interference		EN61326: 1998, Table A1
EMC, radio frequency emission		EN55011 group 1 class A
Shock		100 g/6 ms according to EN60068-2-27
Vibration		15 g, 10 ... 2000 Hz according to EN60068-2-6
Connection		Male socket 8 pin DIN 45326/cable 3 m (standard)

Order Code PCST21

Model Name	PCST21
Measurement Range (in mm)	100 / 500 / 1000 / 1500 / 2000 / 2500 / 3000 / 4000 / 5000 / 5750 Other ranges on request
Output	STSP = with pulse output (start/stop)
Connection	D8 = Connector 8 pin DIN 45326 KAB3M = Cable output, standard length 3 m

Order Code Mating Connector (see accessories page 63)

WS-CONN-D8

Order Code Position Magnet (see accessories page 59)

PCSTMAG...

Order Example: PCST21 - 1500 - STSP - KAB3M

PCST21 POSICHRON[®] Position Sensor

Stick Design with SSI Output



POSICHRON[®] position sensor in stick design

- Protection class IP67
- Measurement range 0 ... 100 up to 0 ... 5750 mm
- Absolute position measurement
- For applications in hydraulic cylinders
- Easy mounting
- Wear- and maintenance-free
- Synchronous serial output (SSI)

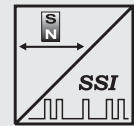

Specifications		
Output	Synchronous serial (SSI)	
Resolution	Typ. 2 µm	
Sampling rate	0.5 ... 2 kHz depending on measurement range	
Linearity	±0.1 mm for ranges ≤500 mm ±0.02 % f.s. for ranges >500 mm	
Housing material	AlMgSi1	
Mounting	Thread M18 x 1,5	
Operating pressure	300 bar, other values on request	
Protection class	IP67 (connector output: with mating connector)	
Operating temperature	-40 ... +85 °C	
EMC, immunity to interference	EN61326: 1998, Table A1	
EMC, radio frequency emission	EN55011 group 1 class A	
Shock	100 g/6 ms according to EN60068-2-27	
Vibration	15 g, 10 ... 2000 Hz according to EN60068-2-6	
Connection	Male socket 8 pin DIN 45326/cable 3 m (standard)	

Order Code PCST21

Model Name PCST21 - - -

Measurement Range (in mm)
100 / 500 / 1000 / 1500 / 2000 / 2500 / 3000 / 4000 / 5000 / 5750
Other ranges on request

Output
SSI = with synchronous serial output (SSI)

Connection
D8 = Connector 8 pin DIN 45326
KAB3M = Cable output, standard length 3 m

Order Code Mating Connector (see accessories page 63)

WS-CONN-D8

Order Code Position Magnet (see accessories page 59)

PCSTMAG...

Order Example: PCST21 - 1500 - SSI - D8

PCST21 POSICHRON[®] Position Sensor Stick Design



Outline Drawing
PCST21
(connector output)

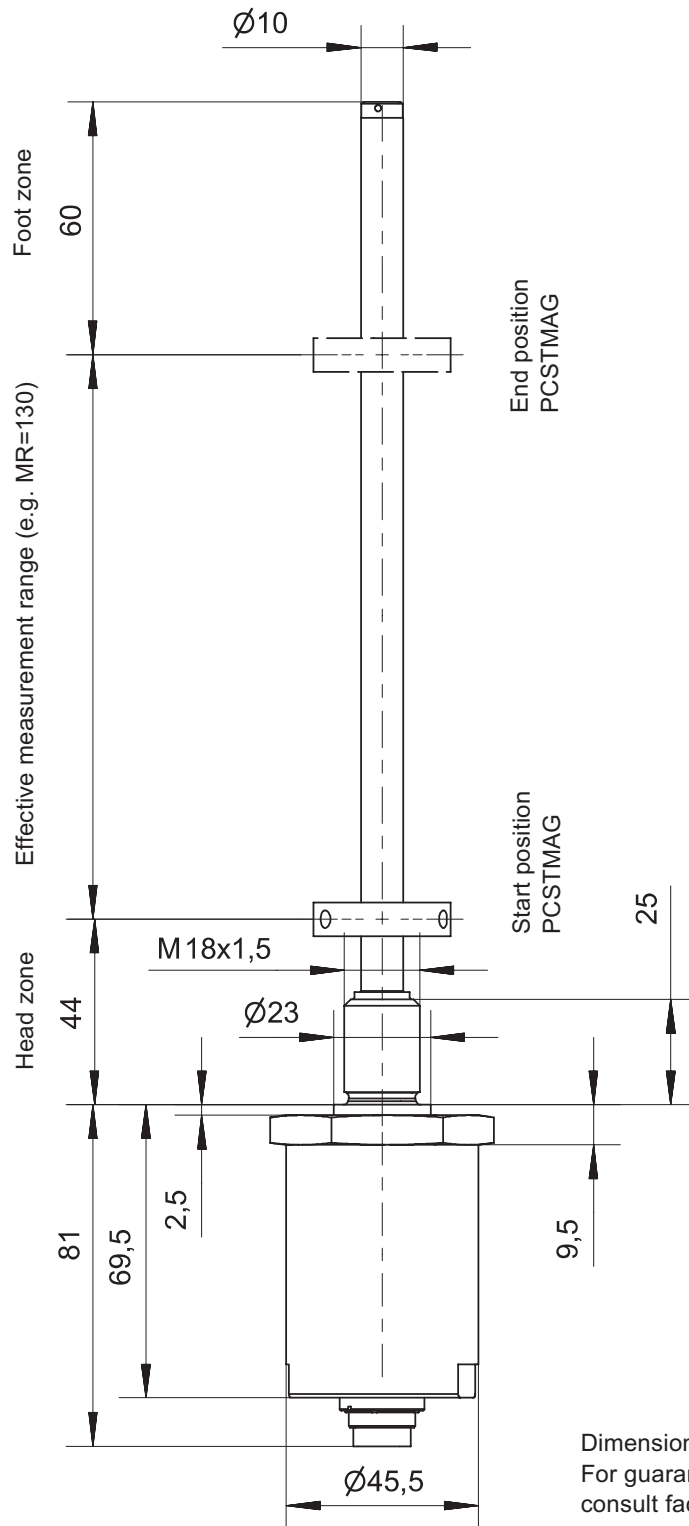
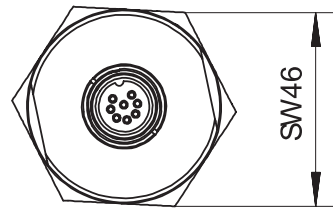

Dimensions informative only
For guaranteed dimensions
consult factory!

PCST21 POSICHRON[®] Position Sensor Stick Design



Outline Drawing
PCST21
(cable output)

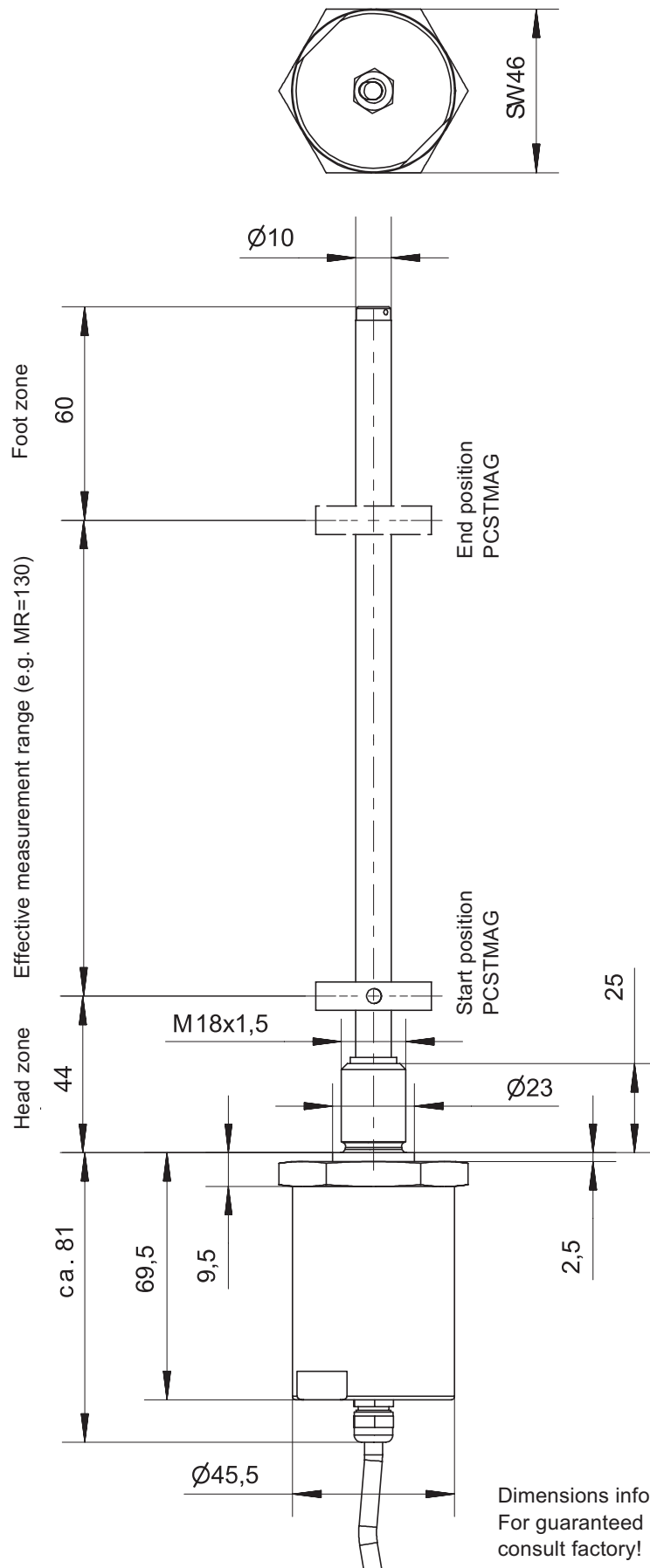

POSICHRON® Output Specification 420T and 10V



Signal Conditioner 420T Current output (3 wire)	Excitation voltage	+18...+27 V DC, residual ripple 10 mV _{SS}
	Excitation current	80 mA max.
	Load resistor	350 Ω max.
	Output current	4 ... 20 mA equivalent to 0 ... 100% range
	Stability (temperature)	±50 x 10 ⁻⁶ / °C full scale
	Protection	Reverse polarity, permanent short circuit
	Output noise	0.5 mV _{RMS}
	Operating temperature	-40 ... +85 °C
	Immunity to interference (EMC)	According to EN 61326: 1998

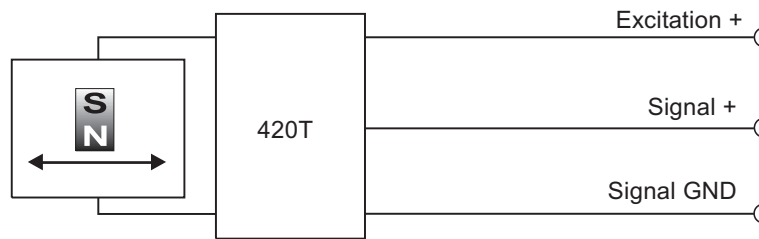

Signal conditioner 10V Voltage output (3 wire)	Excitation voltage	+18 ... +27 V DC, residual ripple 10 mV _{SS}
	Excitation current	80 mA max.
	Output voltage	0 ... +10 V DC equivalent to 0 ... 100% range
	Output current	2 mA max.
	Output load	> 5 kΩ
	Stability (temperature)	±50 x 10 ⁻⁶ / °C full scale
	Protection	Reverse polarity, permanent short circuit
	Output noise	0,5 mV _{RMS}
	Operating temperature	-40 ... +85 °C
Immunity to interference (EMC)	According to EN 61326: 1998	

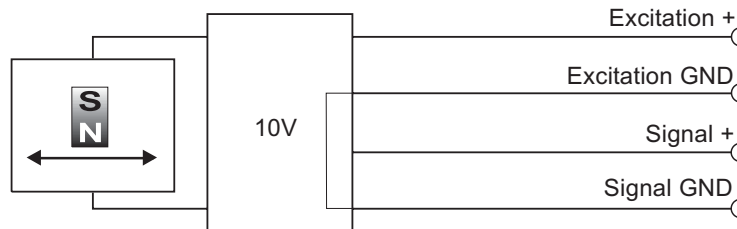

Signal Wiring	Output signals	Connector	Cable colour	
	420T	10V		pin no.
	Excitation +	Excitation +	1	white
	Excitation GND	Excitation GND	2	brown
	Signal +	Signal +	3	green
		Signal GND	4	yellow

Connection
Mating Connector

View to sensor
connector

POSICHRON® Output Specification Pulse Interface



Pulse interface STSP (start/stop) 	Excitation voltage	+18 ... +27 V DC, residual ripple 10 mV _{SS}
	Excitation current	150 mA max.
	Stability (temperature)	±50 x 10 ⁻⁶ / °C full scale
	Wave velocity	2850 ... 2950 m/s
	Level INIT and START/STOP	RS 485 / RS 422
	Protection	Reverse polarity, short circuit
	Operating temperature	-40 ... +85 °C
	EMC, interference resistance	EN61326: 1998, Table A1
EMC, emitted interference	EN55011 Group 1 Class A	

Signal Diagram

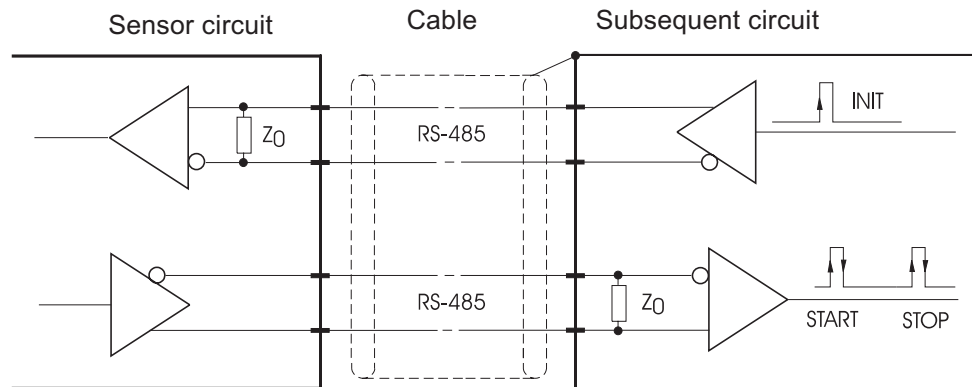

The subsequent circuit generates a signal on the INIT line. The position sensor answers with a START and a STOP signal.

$$\text{Position value } x = t(x) \cdot v_s$$

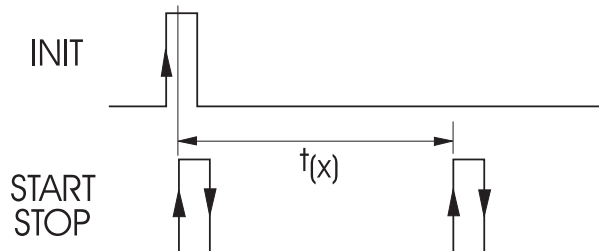

The position value will be calculated by multiplication of the time interval $t(x)$ with the conversion factor specified on the type label.

Signal wiring / connection	Pulse interface	Connector pin no.	Cable colour
	Excitation +	1	white
	Excitation GND	2	brown
	INIT +	3	green
	INIT -	4	yellow
	STSP +	5	grey
	STSP -	6	pink
	Shield	Contact via connector housing	black

Mating connector

View to sensor connector

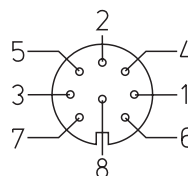

WS-CONN-D8

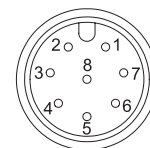

CONN-M12-8P-X

POSICHRON[®] Output Specification SSI



Description

The data transmission takes place by means of the two signals CLOCK and DATA. The processing unit (PLC, Microcomputer) sends pulse sequences which clocks the data transmission at the required transfer rate. With the first falling edge of the pulse sequence the position of the sensor is recorded and stored. The following rising edges control the bit-by-bit transmission of the data word. After a delay time the next new position information will be transmitted.

Data Format (Train of 26 pulses)

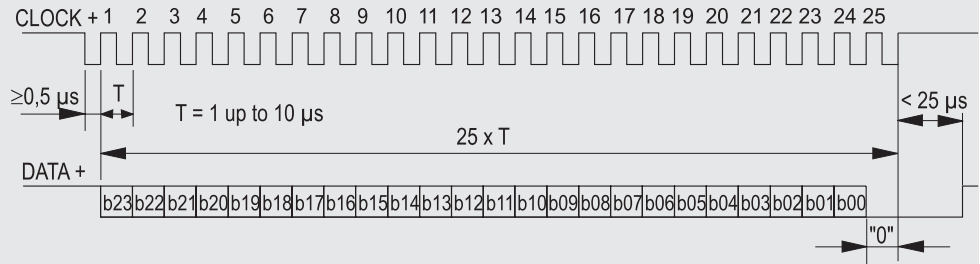

SSI (synchronous serial)



Output	EIA RS-422, RS-485, short-circuit proof
Excitation Voltage	+12 ... +27 V DC, residual ripple 10 mV _{SS}
Excitation Current	150 mA max. without load
Clock Frequency	100 kHz ... 1 MHz
Code	Gray 24 bit, continuous progression
Resolution	2 µm max.
Delay between Pulse Trains	>25 µs
Stability (Temperature)	±20 x 10 ⁻⁶ / °C full scale
Operation Temperature	-40 ... +85 °C
Immunity to Interference (EMC)	According to EN50082-2, EN50081-1

Signal diagram

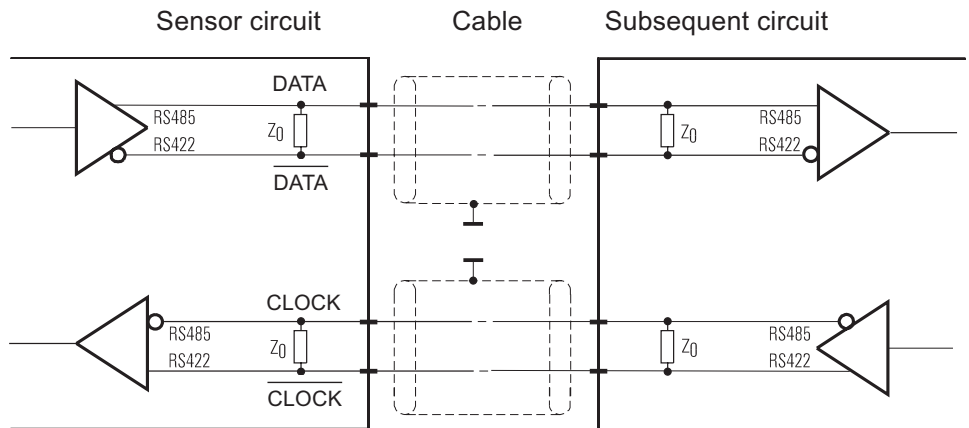

Cable length	Baud rate
50 m	100 ... 1000 kHz
100 m	100 ... 300 kHz

Note:
Extension of the cable length will reduce the maximum transmission rate.
The signals CLOCK/CLOCK and DATA/DATA must be connected in a twisted pair cable, shielded per pair and common.

Signal Wiring / Connection

Signal name	Connector pin no.	Cable colour
Excitation +	1	white
Excitation GND (0V)	2	brown
CLOCK	3	green
CLOCK	4	yellow
DATA	5	grey
DATA	6	pink

