



# PATTON & COOKE CO.

## Shore to Ship Industry Catalogue



[www.pattonandcooke.com](http://www.pattonandcooke.com)

# PATTON & COOKE CO.

## WHAT IS COLD IRONING?

For most people, the issue of global warming has become a part of daily life. And for many, particularly those in coastal communities, declining air quality and the associated health consequences are the most recognizable evidence of the challenges ahead.

As communities begin to demand action on these issues there is mounting pressure on government and industry to provide effective solutions to reduce carbon emissions and to improve air quality. One of the most effective initiatives for reducing green house gases is the development of shore power for the shipping and cruise industries.

Shore to ship power, or "cold ironing", enables clean, shore-generated electrical power to be supplied to the ship's systems while berthed. First developed by the Navy, shore power systems allow ships to shut off their auxiliary engines while in port - thereby eliminating all emissions from those engines.

## WHY DOES COLD IRONING MAKE A DIFFERENCE?

A published report for the European Commission studied the environment factor in the cruise industry. This report concluded that cruise ships in EU ports in 2009 released over 20,000 tonnes of NOx (Nitrogen Oxides), 650 tonnes of SOx (Sulphur Oxides), 1 million tonnes of CO<sub>2</sub> (Carbon Dioxide), and 2,000 tonnes of PM (Particulate Matter).

The European Commission also compared the emissions created from ships' auxiliary engines with emissions created during the generation of an equivalent amount of power at land-based power plants. This study demonstrated that shore-based power supply reduced emissions by at least 90 percent, compared to ships using their own auxiliary engines to create power.

## HOW IS PATTON & COOKE INVOLVED?

Patton & Cooke is the only Authorized supplier to the US Navy for Medium Voltage shore power couplers. For the cruise ship industry, Patton & Cooke has developed a 15kV class, 500 Amp cable coupler, which can be used in single or dual voltage applications including 5 kV, 6.6 kV, 11 kV, and up to 15 kV both at 50 and 60 Hz operation. Our shore power series coupler designs utilize the same features that have made Patton & Cooke couplers the preferred coupler for harsh mining environments worldwide.

Patton & Cooke couplers are also used for mobile equipment and materials handling applications such as gantry cranes, quay cranes, and bulk loaders. Electrification of this equipment further reduces port emissions by eliminating the use of diesel fuel.

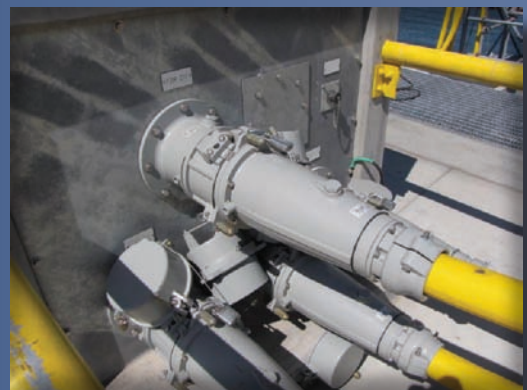

# WE MAKE THE CONNECTION



## SHORE POWER APPLICATION: U.S. NAVY

Patton & Cooke is proud to be the only authorized supplier to the US Navy for medium voltage shore power couplers. For more than a decade, Patton & Cooke has helped deliver power to critical systems aboard the largest and most advanced vessels in the US fleet. Extensive product testing by military contractors have verified the expectation of safe, reliable, and long term performance from Patton & Cooke shore power couplers in marine environments.

### Insulator

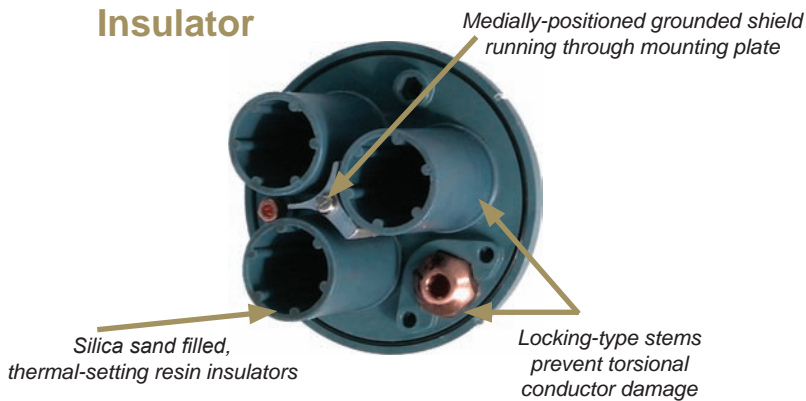

Individually threaded, replaceable phase insulator tubes

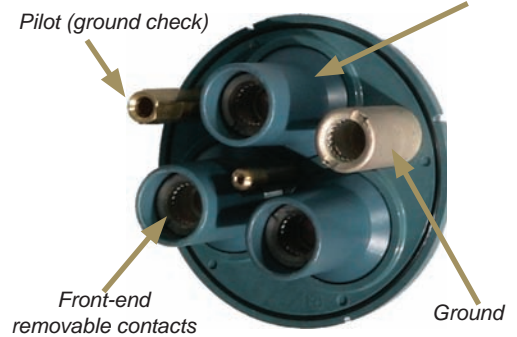

### Body

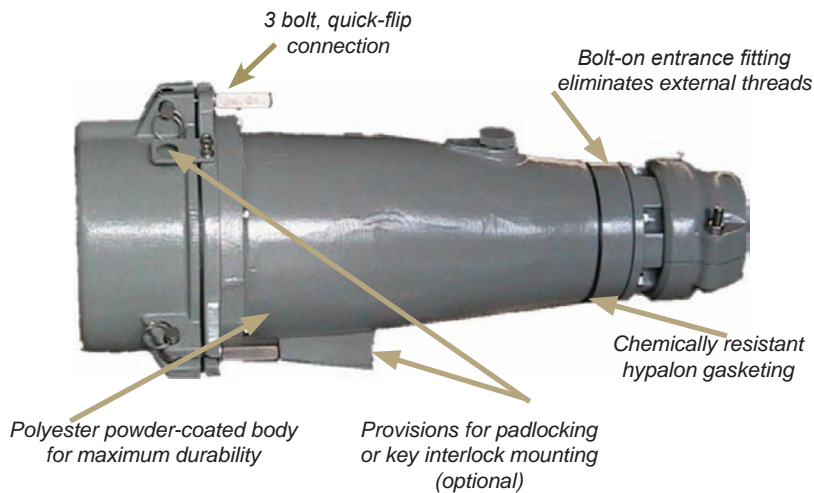

### Entrance Fitting Kit



## ELECTRICAL DATA

<b>Coupler Voltage Class</b> 15.0 kV	<b>1 Minute Dry Withstand (AC)</b> 55.0 kV
<b>6 Hour Dry Withstand (AC)</b> 35.0 kV	<b>15 Minutes Dry Withstand (AC)</b> 75.0 kV
<b>Basic Impulse Level (BIL)</b> 95.0 kV	<b>Short Circuit Fault Level</b> 41.2 kA RMS

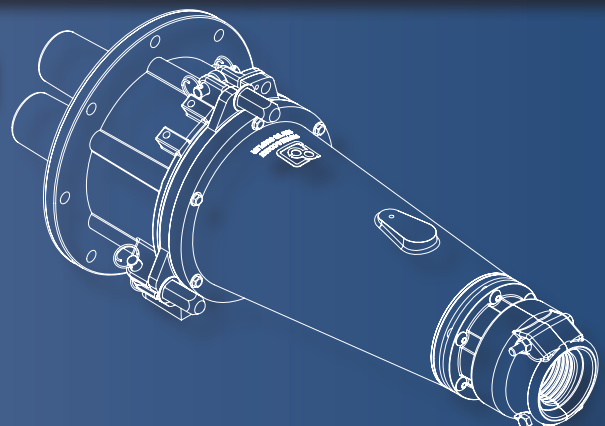

# PATTON & COOKE CO.

## SHORE POWER APPLICATION: CRUISE SHIPS

Shore Power Systems for the cruise industry are now defined in the new triple logo IEC, ISO, IEEE Standard 80005-1 HVSC (High Voltage Shore Connection) systems. The standard describes the scope and functionality of the critical components for multiple classifications of vessels. Patton & Cooke couplers have been selected as the standard for the cruise ship industry, the vessel classification which require the highest electrical loads. Operating at either 6.6 or 11kV, cruise ships may require as much as 18 MW of power to maintain their operations while in port. To meet this power requirement, Patton & Cooke supplies four, 500 Amps couplers which are used in parallel to ensure availability of up to 2,000 Amps of clean generated shore power. Unlike other vessels, cruise ships must be able to transfer power within 30 minutes and without any loss or interruptions of power.

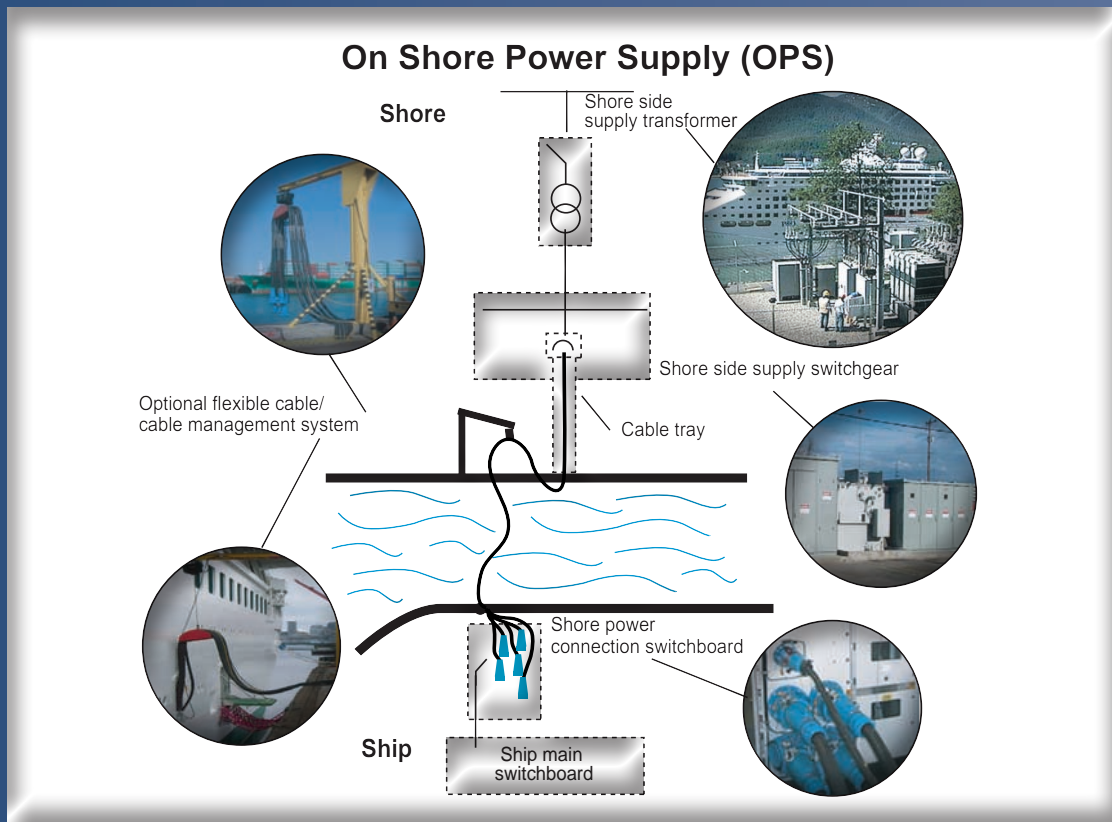

## CRUISE SHIP PART NUMBERS

SHIP INLET	SHIP CONNECTOR	PLUG	SOCKET OUTLET
<b>Power:</b>	<b>Power:</b>	<b>Power:</b>	<b>Power:</b>
<b>CEM150F1094</b> Microswitch, supplied with single phase cables	<b>CEM150F2017</b> Microswitch actuator	<b>CEM150F1199</b> No microswitch	<b>CEM150F2198</b> No actuator
<b>CEM150F1165</b> Microswitch, no cable supplied		<i>For shoreside coupler with microswitch requirement, contact factory.</i>	
<b>Neutral:</b>	<b>Neutral:</b>	<b>Neutral:</b>	<b>Neutral:</b>
<b>CEM11S-001</b> Microswitch, supplied with single phase cable	<b>CEM11S-002</b> Microswitch actuator	<b>CEM11S-004</b> Microswitch actuator	<b>CEM11S-003</b> Microswitch, no cable supplied
<b>CEM11S-005</b> Microswitch, no cable supplied			

## SHORE POWER APPLICATION: RTG - CRANE POWER

Berthed ships are not the only significant source of greenhouse gas emissions, the operation of diesel powered ship to shore cranes and Rubber Tyred Gantry (RTG's) also impact the air quality in ports. To address this problem, some port operators have chosen to convert this equipment to operate on electric power. By integrating cable couplers and readily available cable management systems (cable reelers), port operations are realizing improvements in air quality without any loss of operating efficiency and without exposing personnel to electrical hazards.

Patton & Cooke has worked closely with ports around the world to design and implement specialized coupler solutions which address the specific needs of port operations. These solutions include hybrid couplers and supporting power cables with integrated fiber optic and control wire assemblies. Patton & Cooke's commitment to tailoring products for specific applications means solutions are developed quickly, cost-effectively, and with the reliability that has made Patton & Cooke the premier coupler brand in the world.

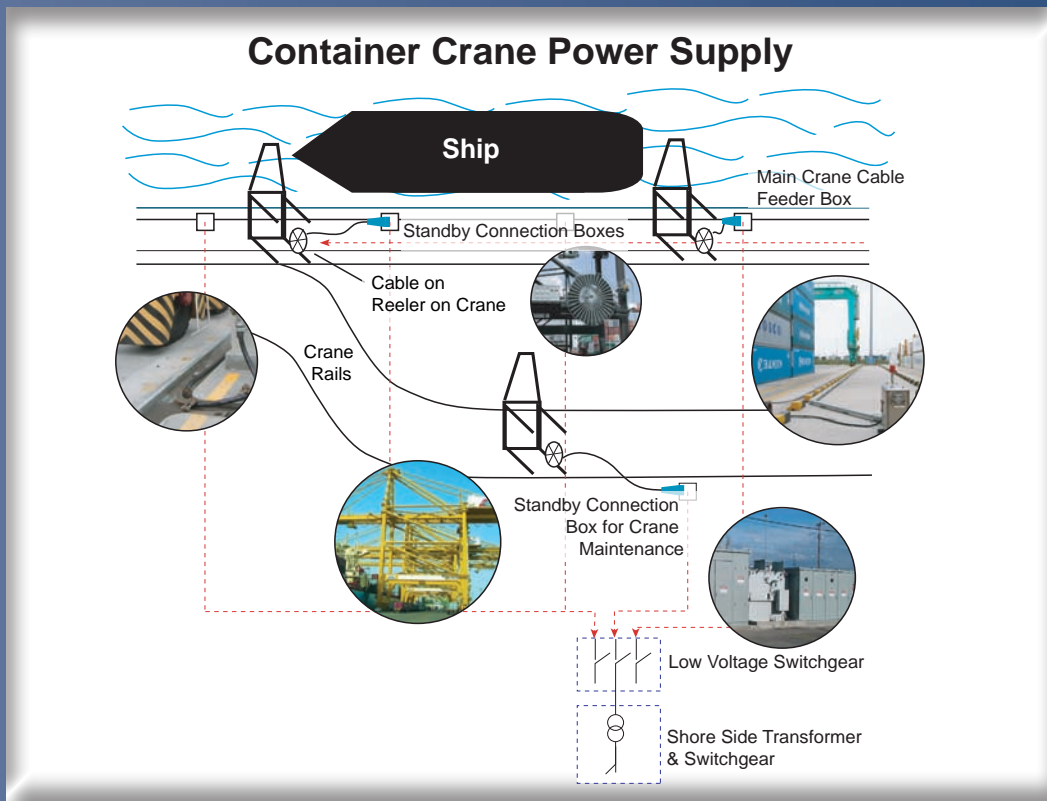

### FEATURES:

- **Quick Coupler System:** helps minimize crane downtime caused by damaged cables by enabling fast changeout of equipment or access to auxiliary power supplies
- **Marine Grade Construction:** heat treated anodized aluminum castings, stainless steel hardware, hypalon gaskets, heavy-duty polyester powder coating
- **Fiber Optic Capabilities:** available with provision for managing cables with integrated fiber optic bundle

### BENEFITS:

- Reduce crane downtime
- Easy, on-site front-end maintenance of live parts

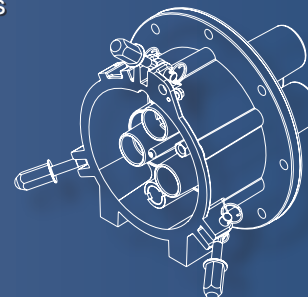

# PATTON & COOKE CO.

## RTG - CRANE POWER PART NUMBERS

**TABLE A: 500 AMP COUPLER CATALOGUE NUMBERS**

Coupler Rating (A)	Male/Female	Mounting Options	Outside Cable Diameter Range		Patton & Cooke Catalogue Number
			(mm)	(in)	
500	M	Cable Mount	20.8-47.5	0.82-1.87	<b>C150F1003<sub>x-y</sub></b>
			47.8-60.2	1.88-2.37	<b>C150F1004<sub>x-y</sub></b>
			60.5-69.9	2.38-2.75	<b>C150F1005<sub>x-y</sub></b>
			70.1-88.9	2.76-3.50	<b>C150F1006<sub>x-y</sub></b>
	F	Cable Mount	20.8-47.5	0.82-1.87	<b>C150F2005<sub>x-y</sub></b>
			47.8-60.2	1.88-2.37	<b>C150F2006<sub>x-y</sub></b>
			60.5-69.9	2.38-2.75	<b>C150F2007<sub>x-y</sub></b>
			70.1-88.9	2.76-3.50	<b>C150F2008<sub>x-y</sub></b>
M	Equipment Mount	N/A		<b>C150F1007<sub>x-y</sub></b>	
F		N/A		<b>C150F2009<sub>x-y</sub></b>	

**TABLE B: 500 AMP COUPLER CATALOGUE SUFFIX - <sub>x</sub>**

Max. Cable Size SHD-GC 5 - 25kV		<sub>x</sub> -Cat. No. Suffix	Max. Cable Size SHD-GC 5 - 25kV		<sub>x</sub> -Cat. No. Suffix
(mm <sup>2</sup> )	(AWG)		(mm)	(AWG)	
34	#2	<b>F</b>	127	250 MCM	<b>M</b>
42	#1	<b>G</b>	152	300 MCM	<b>N</b>
54	1/0	<b>H</b>	178	350 MCM	<b>O</b>
67	2/0	<b>J</b>	203	400 MCM	<b>P</b>
85	3/0	<b>K</b>	228	450 MCM	<b>Q</b>
107	4/0	<b>L</b>	254	500 MCM	<b>R</b>

**TABLE C: ELECTROSTATIC EPOXY POWDER COATING SUFFIX - <sub>y</sub>**

Colour	Code	Colour	Code
Blue	<b>EB</b>	Grey	<b>EGR</b>
Orange	<b>EO</b>	Brown	<b>EBR</b>
White	<b>EW</b>	Black	<b>EBK</b>
Yellow	<b>EY</b>	Violet	<b>EV</b>
Green	<b>EG</b>	Blue Grey	<b>EBG</b>
Red	<b>ER</b>		

**TABLE D: COUPLER ENTRANCE FITTING GASKET KITS (FOR CABLE MOUNT COUPLERS)**

Outside Cable Diameter		Catalogue Number	Outside Cable Diameter		Catalogue Number
(mm)	(in)		(mm)	(in)	
20.8-22.1	0.82-0.87	<b>C150F3004</b>	51.1-53.8	2.01-2.12	<b>C150F3016</b>
22.4-23.9	0.88-0.94	<b>C150F3005</b>	54.1-57.2	2.13-2.25	<b>C150F3017</b>
24.1-25.7	0.95-1.01	<b>C150F3006</b>	57.4-60.2	2.26-2.37	<b>C150F3018</b>
25.9-26.9	1.02-1.06	<b>C150F3007</b>	60.5-63.5	2.38-2.50	<b>C150F3019</b>
27.2-28.4	1.07-1.12	<b>C150F3008</b>	63.8-66.5	2.51-2.62	<b>C150F3020</b>
28.7-31.8	1.13-1.25	<b>C150F3009</b>	66.8-69.9	2.63-2.75	<b>C150F3021</b>
32.0-34.8	1.26-1.37	<b>C150F3010</b>	70.1-72.9	2.76-2.87	<b>C150F3022</b>
35.0-38.1	1.38-1.50	<b>C150F3011</b>	73.2-76.2	2.88-3.00	<b>C150F3023</b>
38.4-41.1	1.51-1.62	<b>C150F3012</b>	76.5-79.2	3.01-3.12	<b>C150F3024</b>
41.4-44.5	1.63-1.75	<b>C150F3013</b>	79.5-82.6	3.13-3.25	<b>C150F3025</b>
44.7-47.5	1.76-1.87	<b>C150F3014</b>	82.8-85.6	3.26-3.37	<b>C150F3026</b>
47.8-50.8	1.88-2.00	<b>C150F3015</b>	85.9-88.9	3.38-3.50	<b>C150F3027</b>

## CHOOSING YOUR COUPLER

Contact Structure: 3 Power + 1 Ground + 1 Pilot

When ordering the Patton & Cooke 15kV coupler, please specify our catalogue numbers, your cable type, size, and diameter. For cable mount couplers, entrance fitting kits must be purchased separately.

### STEP 1.

- Determine the following: Male (plug) or Female (receptacle) contacts (Table A).
- For equipment mounting, select catalogue number of coupler.
- For cable mounting, determine outside cable diameter and select catalogue number of coupler.

### STEP 2.

Determine conductor size and substitute appropriate code for "x" in the catalogue number (Table B).

### STEP 3.

Determine the powder coating colour and substitute appropriate code from (Table C) into position "y" of the selected part number.

### STEP 4.

Determine exact cable O.D. and choose appropriate entrance fitting gasket kit (Table D).

## COUPLER WEIGHTS & DIMENSIONS

Illustration (not to scale)	Dimensions	Weight	Illustration (not to scale)	Dimensions	Weight
<b>CABLE MOUNTED MALE</b> 	A 20 ¼" 514 mm B 10 ½" 267 mm C 24 ½" 622 mm	38.0 lb 17.0 kg	<b>CABLE MOUNTED FEMALE</b> 	A 24" 610 mm B 11 ½" 292 mm C 27" 686 mm	38.0 lb 17.0 kg
<b>EQUIPMENT MOUNTED MALE</b> 	A 4 ¾" 121 mm B 12 ¼" 311 mm C 9" 229 mm D 11" 279 mm E 1 ½" 38 mm	32.0 lb 14.5 kg	<b>EQUIPMENT MOUNTED FEMALE</b> 	A 5 ¼" 133 mm B 12 ¼" 311 mm C 8 ¼" 210 mm D 11" 279 mm E 4" 102 mm	27.0 lb 12.3 kg

## SPECIAL NOTES:

All couplers and junction boxes are supplied with a cover, attachment chain, and provision for padlocking two mated couplers and/or covers. Termination kits and potting compound can be purchased separately. Potting compound is recommended for 15kV couplers and junction boxes. Standard terminations for phase and pilot conductors are designed for soldering. Grounds are mechanical type.

Assembly procedure can be accomplished using standard tools. Detailed installation guides and material requirements are provided with each coupler.



## HOW TO ORDER

For a copy of our product catalogue, or for further information about our growing range of high voltage electrical equipment for the mining industry, call or email us.

## PATTON & COOKE CO.

#100 - 7795 128th Street,

Surrey, BC V3W 4E6

CANADA

**PHONE:** 604.591.5374

**TOLL FREE:** 1.866.591.5374 (N. America)

**FAX:** 604.591.3505

**EMAIL:** [info@pattonandcooke.com](mailto:info@pattonandcooke.com)

**WEBSITE:** [www.pattonandcooke.com](http://www.pattonandcooke.com)

