



MICROWAVE SENSOR

MWS-ST-11 [TRANSMITTER]

MWS-SR-11 [RECEIVER]

PAT. PEND.

**300%
Increased Range**



WADECO CO.,LTD.

MICROWAVE SENSOR MWS-ST-11/SR-11

Due to the sensor's high penetrability, surface contaminants and harsh environments do not affect its operation.

General

The MWS-ST/SR type microwave sensor is a level switch consisting of a transmitter (MWS-ST) and a receiver (MWS-SR) installed face-to-face. The transmitter emits a continuous, low power microwave beam towards the receiver and an output relay is released when the beam is obstructed. The sensor has wide application across all areas of industry where highly reliable, non-contact level detection is required. The sensor is generally used for process control by monitoring presence/absence of product, flow/no flow conditions and point level detection in bins and silos. The sensor may also be used as a proximity switch for detection of vehicles such as dump trucks and rail cars.

Features

- High penetration**
 Easily penetrates process buildup on antenna, firebrick, refractory etc., thanks to the increased operating range.
- Unaffected by adverse environments**
 The sensor is unaffected by surface contaminants, flames, steam, vapor or airborne particles.
- Simple beam alignment**
 Easy initial beam alignment at installation, due to the wide beam angle.
- Selectable detection mode**
 Either broken beam (BLOCK) or unbroken beam (UNBLOCK) detection method may be selected.
- Small sensing head (Ø27mm/1in)**
 Approximately 100m/325ft range with Ø27mm/1in antenna.
- Enclosure rating IP65/NEMA4 equivalent**

Penetrability of microwaves

Harsh environments may result in a buildup of contaminants on the sensing head; however, the sensor is easily able to penetrate such buildup thanks to the high penetrability of microwaves. When microwaves transmitted through air encounter an object, some will be reflected, some absorbed and the rest will pass through the object. The amount of microwaves passing through the object depends on its composition. Generally speaking, microwaves cannot penetrate metals and are reflected; water absorbs the most microwaves.

State-of-the-art Heterodyne Detection Method

The MWS-ST/SR level switch is the first of its kind to utilize the heterodyne detection method rather than the, now obsolete, diode detection method.

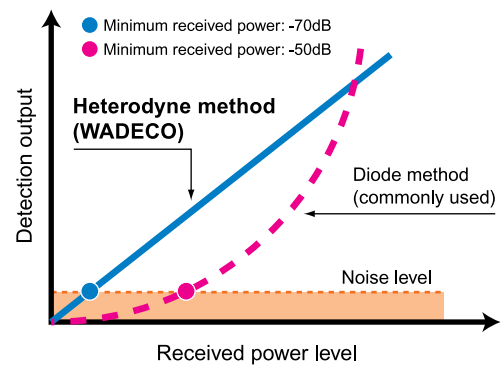

The heterodyne detection method gives detection output that is proportional to the received power level, whereas the diode detection method gives detection output that is proportional to the square of the received power level. Therefore the heterodyne method allows detection with a minimum received power that is lower than that of the minimum level required by the diode detection method. This greatly increases the operating range/penetrability without any increase in the power of the transmitted microwave radiation.

Wiring

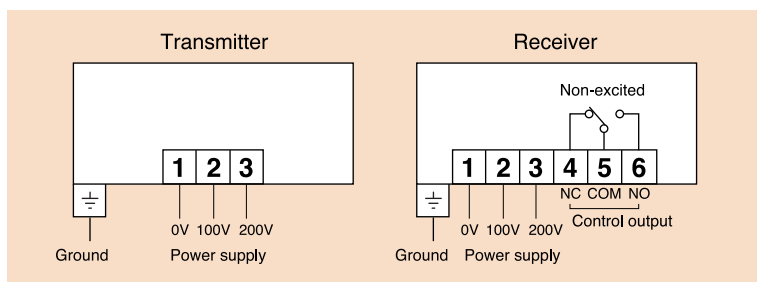

Selection of detection mode and relay configuration.

Detection mode		Beam broken BLOCK		Beam unbroken UNBLOCK	
		4 & 5	5 & 6	4 & 5	5 & 6
Unpowered state		Closed	Open	Closed	Open
Powered state	Non-detecting state	Open	Closed	Open	Closed
	Detecting state	Closed	Open	Closed	Open

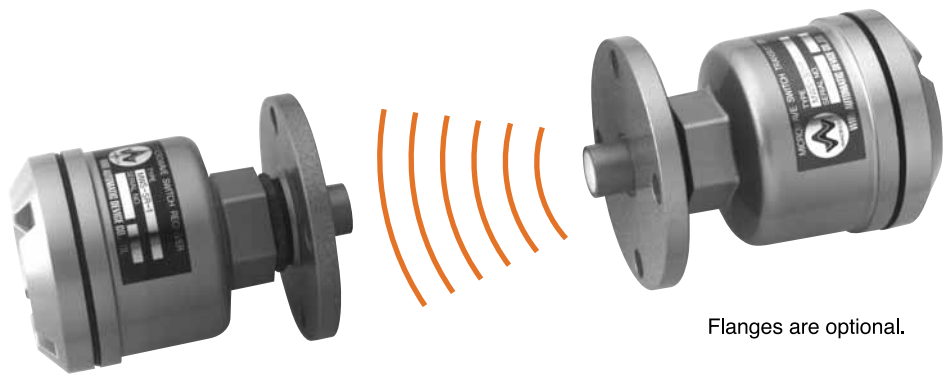

Flanges are optional.

Function of receiver switches and rheostats

Adjustment

Transmitter

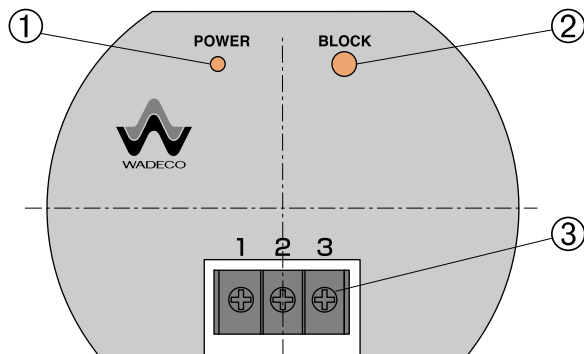

	Part Name	Description
①	Power indicator	Green when power is on
②	Block button	Blocks transmission
③	Terminals	Power supply(1~3)

Receiver

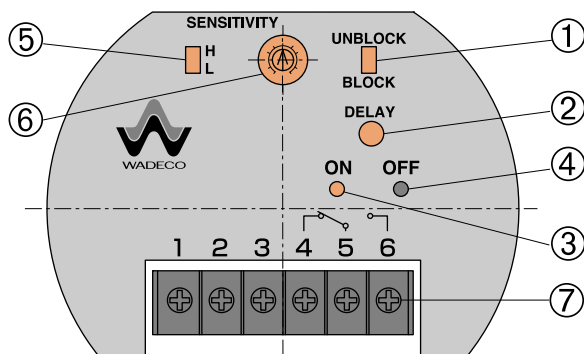

	Part Name	Description
①	Mode selection switch	BLOCK: Outputs on broken beam UNBLOCK: Outputs on unbroken beam
②	Delay time rheostat	0.1 - 10sec. delay period after state changes
③	Output indicator	ON (red) : Illuminates on output
④	Output indicator	OFF (green) : Illuminates on no output
⑤	Sensitivity switch	H:High sensitivity L:Low sensitivity
⑥	Sensitivity rheostat	For sensitivity adjustment
⑦	Terminals	Power supply(1~3) and relay contacts(4~6)

After installation is complete, adjust the following with the sensor in the UNBLOCK state.

Transmitter

- Upon turning on the power supply, the POWER light ①(Green) will come on.

Receiver

- Upon turning on the power supply, either the red BLOCK light ③ or the green UNBLOCK light ④ will come on.
- Turn mode selection switch ① to BLOCK, turn the sensitivity switch ⑤ to L and turn the delay time rheostat ② fully counter-clockwise (minimum).
- Set the sensitivity rheostat ⑥ to minimum.
- The red output indicator ON ③ will come on.
- Slowly turn the sensitivity rheostat ⑥ clockwise until the green output indicator OFF ④ comes on. This is to determine the actuation point. If this sensitivity setting is very high (more than 7 on the rheostat) switch the sensitivity switch ⑤ to H and repeat the above procedure.
- For applications involving mainly paper and/or where there is little accumulation on the sensing head, increment the rheostat ⑥ by 1 or 2 levels only. On the other hand, where the application involves material with a moderately high water content, i.e. wet garbage etc, then the rheostat ⑥ should be incremented by 3-4 steps. However, if the object to be detected absorbs microwaves well, (i.e. coal), then the rheostat ⑥ can be incremented by more than 5 steps.

- For an application where material is introduced from above, a suitable "delay" time must be provided to avoid instantaneous detection of the falling material.
- To use UNBLOCK output mode, switch the mode selection switch ① to UNBLOCK.



Specifications

	Transmitter	Receiver
Type	MWS-ST-11	MWS-SR-11
Power supply	AC100~120V or AC200~240V $\pm 10\%$, 50/60Hz (DC24V is optionally available)	
Power consumption	2VA	2VA
*Operating distance	80m/262ft or less	
Frequency and transmission power	Approx. 24GHz, less than 10mW	
Compliance	FCC Title Rule 15 and OSHA exposure specification section 1910.97	
Radiation angle	Approx. $\pm 20^\circ$ (angle in half of receiving value)	
Output contact	1C relay contact AC250V, 2A ($\cos\phi=1$), relay is unexcited during output state	
Response time	10msec.	
On delay	0.1 ~ 10sec.	
Delay time from power on to function	Approx. 50msec.	Approx. 5sec.
Noise tolerance	Square wave noise from noise simulator (rising time: 1 nanosecond, width: 1 microsecond), ± 1.5 KV (normal and common modes), with the frequency of the power supply in the $0^\circ \sim 360^\circ$ phase.	
Operating ambient temperature	$-10^\circ\text{C} \sim +55^\circ\text{C}$	
Non-function ambient temperature	$-20^\circ\text{C} \sim +70^\circ\text{C}$	
Continuous maximum pressure	0.5MPa	
Enclosure rating	IP65/NEMA4 equivalent	
Enclosure construction	Diecast aluminum	
Color	Metallic silver grey	
Weight	1kg	1kg

* The operating distance may vary from sensor to sensor and according to installation.

Installation

Install the transmitter and receiver face to face as shown below.

Both unit's cable entry should face in the same direction, or be 180° opposite each other.

Cable entry in the same direction.

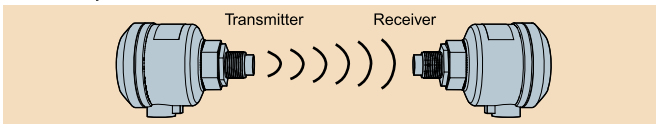

Cable entry 180° opposite each other.

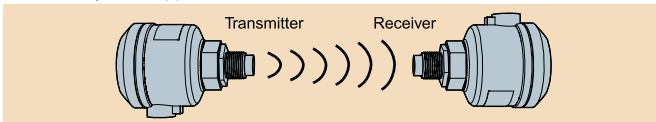

If the units are installed with cable entries at 90° to each other they will not function.

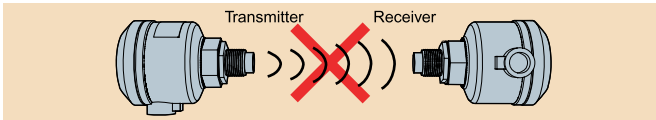

If two transmitter-receiver sets are installed in close proximity, one transmitter-receiver set should be mounted at a 90° angle to the other so that the waves of one unit will not interfere with the other's.

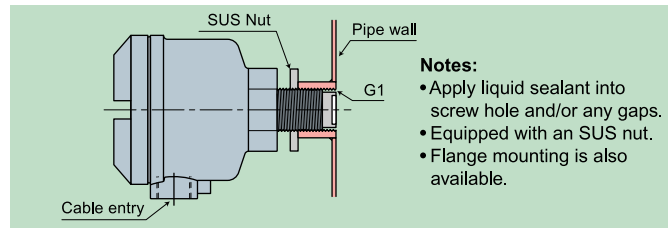
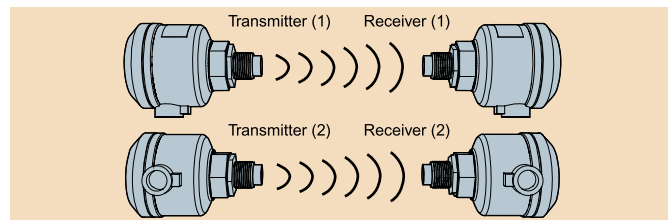

Dimensions

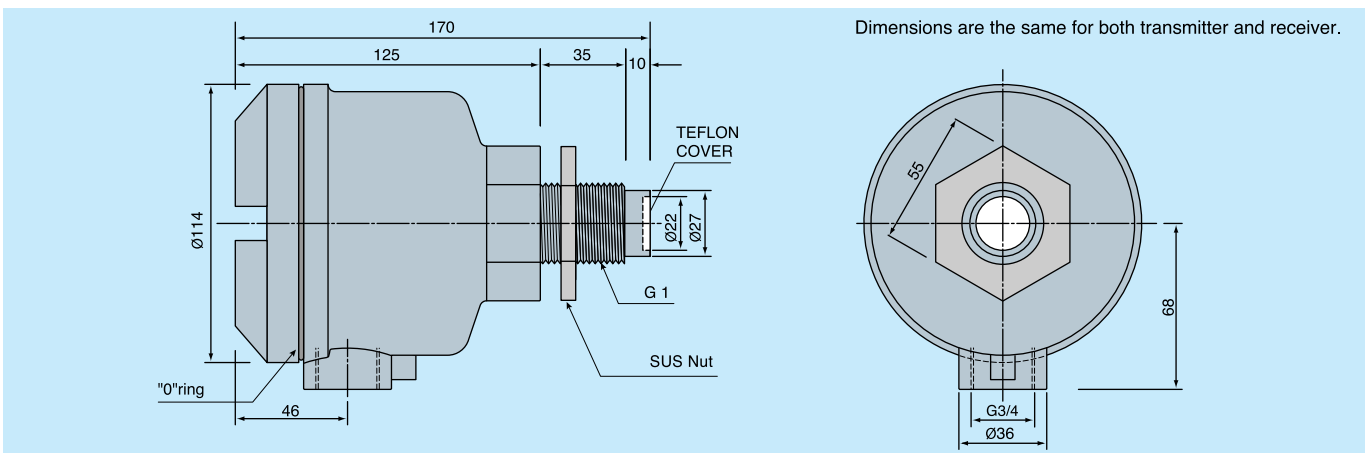

This specification may be changed without notification.

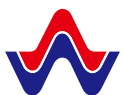

WADECO CO.,LTD.

HEAD OFFICE WADECO Bld., 1-12-9, Meishin-cho, Amagasaki-shi,
Hyogo-ken 661-0021, Japan
TEL.+81-6-6482-3838 FAX.+81-6-6481-6321

TOKYO BRANCH 202 Shibuya-homes,2-1,Udagawa-cho,Shibuya-ku,Tokyo
150-0042,Japan
TEL.+81-3-3770-5519 FAX.+81-3-3770-5520
URL : <http://www.wadeco.co.jp>