

Workplace systems Overview

- 1
- 2
- 3
- 4
- 5
- 6
- 7

451



**Worktable
joke Ergo-Work**

455



Work chairs

457

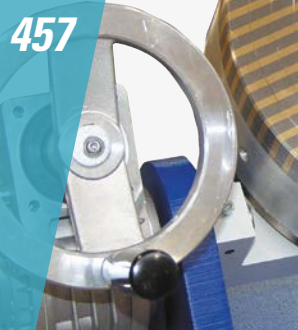

Clamping table DS 300

461



Engraving ball

463



**LED illuminated magnifying
lamp Magic touch**

472



Technical sprays

490



**Hand, ear, eye and
breathing protection**

487



Assortment case

492



Suction units

497



Deburring box

498



Stereomicroscopes

505



**Digital video camera for
stereomicroscopes**

506



LED ring light

507



Cold light sources

511



**Binocular LED headband
magnifying glass**

515



Inspection systems 2500

452 Workshop equipment

Worktable und Stative
Work chairs
Clamping devices
Workplace lighting
Cleaning, polishing & caring
Precision impression
Cutting oils and sprays
Hand, ear, eye and breathing protection
Surface protection
Precision gauge tapes
Assortment case
Suction units
Deburring box

498 Microscopes and control tools

Stereomicroscopes
Digital picture storage
Cold light sources
Magnifying glasses

514 Inspection systems

Inspection systems 2500
WiFi Digital Microscope
Flexible endoscope

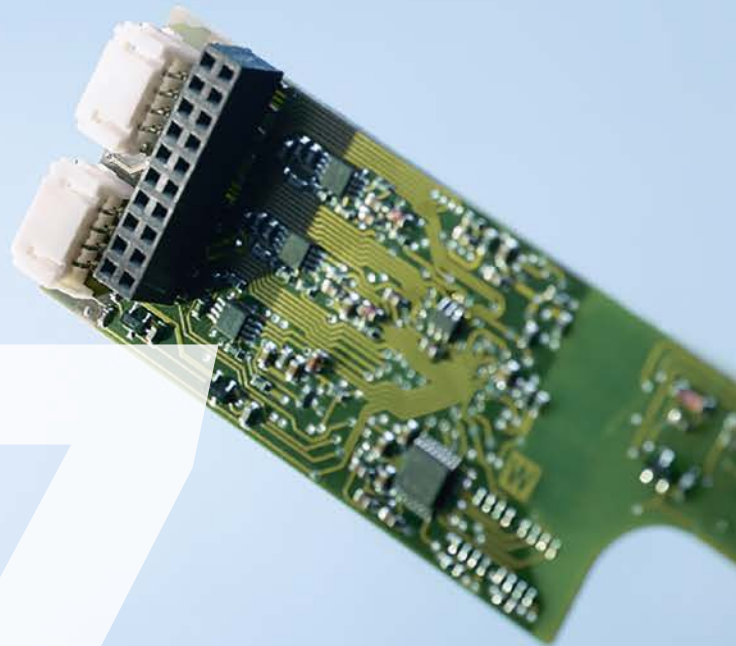



Workshop equipment

Ergonomic and convenient work

We would like you to work at modern workplaces. Workplaces that offer you comfort and make your work a good deal easier. Workplaces that adapt to your needs and deliberately avoid damage to health through compliance with ergonomic requirements.

Workplaces made by joke

Our workplaces combine modern ergonomic knowledge with requirements based on practice. Modern worktables and tripods are the result, which although they cannot do the work for you, may nevertheless make it a good deal easier. Working with first-rate "hardware" is ultimately a great deal more enjoyable and your body will thank you for it at any rate.

452 Worktables, stands

456 Clamping devices

468 Workshop supplies

455 Work chairs

462 Workplace lighting

492 Suction units



Worktable joke Ergo-Work

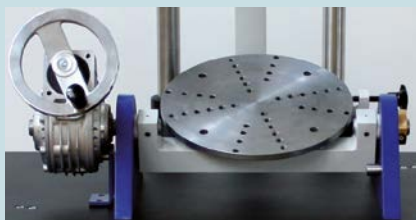

Clamping table DS 300 with clamping plate Ø 300 mm

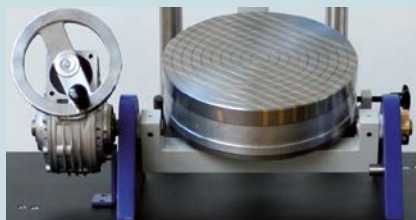

Clamping table DS 300 with magnet



Positionierer joke easy-Work mit T-Nutenplatte



Basic module (with control cabinet and foot switch)



Storage column (left) and extension arm for hanging motor (right)



Illuminated magnifying glass

Worktable joke Ergo-Work Basic module

Worktable joke Ergo-Work

Maximum flexibility thanks to the modular system. The joke Ergo-Work worktable can be perfectly adjusted to your requirements – simply choose the accessories you need to create your perfect workplace. The worktable adjustable in height by 355 mm, with a choice of milled aluminium or powder-coated steel tabletop, always forms the basis in this case.

All the optionally available accessories can be attached to this table: from device receptacles for the ENESKA systems and the jokeFlex motor unit to the illuminated magnifying glass to give you the perfect view of your workpiece. Everything travels together with the worktable with millimetre precision to the desired working height. The upwards and downwards movement is controlled by hand or foot switch.

Two rotating and pivoting units are provided for receiving tools: The DS 300 clamping table provides a firm grip for large, heavy workpieces whilst the easy-work rotating and pivoting unit hold (light to medium-weight) workpieces. Furthermore, the worktop can be fitted with a conventional bench vice or another rotating and reversible clamping device.



Highlights:

- perfect working position at all times owing to simple electric height adjustment
- modular system guarantees maximum equipment flexibility
- wide range of matching accessories

Note: the scope of supply does not include accessories, work chair and pivoting unit





		Order No.	Price from 1 piece
Worktable joke Ergo-Work basic modules			
	Dimension (W x H x D):	970 x 1,600 x 680 mm	0 200 850 2949.00 €
	Dim. tabletop (W x H x D):	950 x 500 mm	
	Height adjustment:	695 to 1,050 mm, continuously adjustable	
	Max. load:	200 kg (at the centre of the worktop)	
	Supply voltage:	230 V, 50/60 Hz	
	Connected load:	400 W (excl. accessories)	
Scope of delivery:	Excl. accessories and pivot unit with steel tabletop		

Accessories / spare parts

		Order No.	Price from 1 piece
Hand switch			
	to control up and down movement, incl. 1 m cable	0 200 852	28.40 €
Foot switch			
	to control up and down movement by foot, incl. 1 m cable	0 200 853	197.00 €
Socket strip (6 -point)			
		2 017 751	64.20 €

Worktable joke Ergo-Work Basic module

Accessories / spare parts

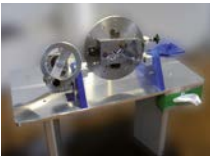
		Order No.	Price from 1 piece
Storage table			
	incl. cross clamping unit, height locking, stainless steel tube and tray	0 200 856	304.00 €
Left-hand column for trays			
	incl. attachment base and stainless steel tube	0 200 855	118.50 €
Right-hand column for hanging motor			
		0 200 857	137.15 €
Cantilever arm for hanging motor			
	incl. cross clamping unit, height locking, stainless steel tube and receptacle for hanging motor	0 200 858	228.00 €
Illuminated magnifying glass LED Premium			
	Equipment: LED's, energy efficiency class A+ Colour temperature: 4,000 K Mains connection cable: ca. 3 m, earthing plug Material: steel tubing, powder-coated Articulated arm range: 700 mm Light output: LED-light segments switchable in multi stages Lamp cover: shade, matt Joint relief: spring Pivoting range: 60° / 310° Rotation range: 360° magnifying glass Protection class: I Protection: IP 20 Power input: about 12 W Dimensions of lens: 162 x 105 mm Dioptres, lens: 3 Supply voltage: 220 – 240 V / 50/60 Hz Weight: approx. 4.5 kg Colour: RAL 7035 Specific features: light segments can be switched seperately, excelent colour reproduction, RA > 95	0 200 560-LED	587.00 €
Clamping table joke DS 300, without base plate			
	With clamping plate plate Ø 300 mm with grid holes M10 and receiving holes for magnets Rotation range: 360° manual Pivoting range: 0 – 100° through gearing mechanism Weight: approx. 28 kg	0 200 300-1	2564.00 €

Worktable joke JT

Worktable joke JT 600

Probably one of the fastest and at the same time sturdiest height-adjustable worktables of its kind that appeals by its many accessory options!

- Load-bearing capacity 570 kg
- Electric height adjustment between 715 and 1,215 mm
- Speed of 43 mm/sec.
- Memory control with 3 memory locations
- Ideal for use in the industrial sector and the electronic & pharmaceutical industry
- Electrical connection 230 V / 50 Hz

Optionally available:

- With storage battery
- On castors
- Laboratory version
- ESD version
- As machine base frame without tabletop (load-bearing capacity 620 kg)
- Heavy-duty table (load-bearing capacity 2,400 kg)
- Perforated walls
- Power strips
- Base cabinet



		Order No.	Price from 1 piece
Worktable JT 600 with beech Multiplex tabletop 40 mm			
Number of lifting jack columns:	4	0 200 848	2933.00 €
Lifting system:	Electric		
Operator control element:	6-button display, memory function		
Load-bearing capacity kg:	570		
Max. speed without load:	43 mm/sec.		
Stroke length:	500 mm		
Dimensions (W x D):	1,500 x 750 mm		
Number of lifting jack columns:	4	0 200 847	3055.00 €
Lifting system:	Electric		
Operator control element:	6-button display, memory function		
Load-bearing capacity kg:	570		
Max. speed without load:	43 mm/sec.		
Stroke length:	500 mm		
Dimensions (W x D):	2,000 x 750 mm		

Standing aid

Standing aid

Even if you prefer to stand whilst working instead of sitting down – you still need the necessary support. Our standing aid relieves you during stand-up jobs resulting in enhanced efficiency with fewer inactivity periods due to injuries caused by poor posture.

- Integral foam padding
- Seat inclination 2–15° forwards
- Circular base with PU rim (anti-slip)
- Seat height adjustment by means of a pneumatic safety spring

		Order No.	Price from 1 piece
Standing aid			
	Seat height:	630 – 850 mm	0 200 419 283.00 €
	Seat surface (W x D):	390 x 350 mm	
	Circular base:	Ø 430 mm	



Work chairs

Work chairs

The fact that healthy, proper sitting posture is a prerequisite for an ergonomic workplace is no secret in today's working world. Yet only very few companies pay attention to this basic principle.

Our joke work chairs actively contribute to maintaining your health. The contact backrest with adjustable pressure constantly adapts to your sitting position and ensures that your spine is supported in every position. Our contribution to active prevention of back injuries: take a seat, please.

- Adjustable backrest pressure
- Backrest inclination 10° in both directions
- Seat inclination 7° forwards, 4° rearwards
- Integral foam upholstery
- Seat height adjustment by means of a pneumatic safety spring
- Circular base with PU rim (anti-slip) for a secure hold

		Order No.	Price from 1 piece
Work chair joke Standard			
	Seat height:	450 – 630 mm	0 200 413 458.00 €
	Seat surface (W x D):	460 x 435 mm	
	Circular base:	Ø 430 mm	
Work chair joke Extra-high			
	Seat height:	630 – 880 mm	0 200 414 478.00 €
	Seat surface (W x D):	460 x 435 mm	
	Circular base:	Ø 560 mm	

Positioner joke easy-Work for attachment to table

Positioner joke easy-Work

Compact and very flexible to use: the small rotating and pivoting unit unit joke easy-Work can be attached quickly and securely to almost any table by means of the drillings, such as the large joke Ergo-Work worktable.

The optionally available T-slot clamping plates ensure make fixing the workpieces child's play. These plates are made from aluminium and are optionally available in square or round shape.



360° rotation range

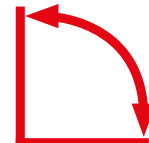

90° pivot range

		Order No.	Price from 1 piece
joke easy-Work positioner with magnet Ø 125 mm			
Rotation range:	manually through 360°	0 200 872	1091.00 €
Pivoting range:	0 – 90° manually		
Dimensions (W x H x D):	200 x 160 x 250 mm		
Weight:	approx. 11 kg		
Clamping system:	Magnet Ø 125 mm		



		Order No.	Price from 1 piece
joke easy-Work positioner with T-slot clamping plate, round			
Rotation range:	360° manual	0 200 873	937.00 €
Pivoting range:	0 – 90° manual		
Dimensions (W x H x D):	250 x 130 x 250 mm		
Weight:	approx. 8 kg		
Clamping system:	T-slot clamping plate, Ø 248 mm		



Clamping table joke DS 300

Clamping table joke DS 300

Workpieces of up to 200 kg can be clamped to the DS 300 clamping table, pivoted within a range of 0 to 100° and rotated by 360° on the turntable. The turntable locking and self-locking pivoting drive ensure a secure hold of the workpiece in any working position. The grid hole clamping plate with M10 tensioning medium can be used to clamp any workpieces easily. A selection of different magnetic chucks is available that can be directly screwed to the table.

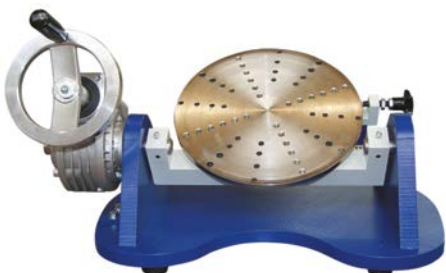

		Order No.	Price from 1 piece
Clamping table joke DS 300			
	With Ø 300 mm support plate to hold different magnetic chucks. Grid holes M10 4 x 90° for mechanical clamping without magnetic chucks.	0 200 300	2746.00 €
	Dimensions base plate: 470 x 420 mm Height turntable: approx. 130 mm Weight: 46 kg		

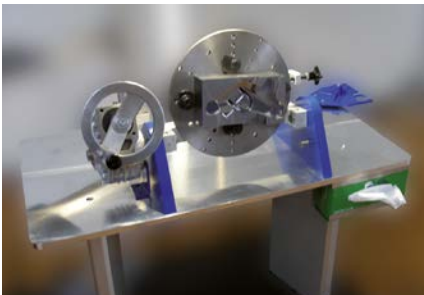
		Order No.	Price from 1 piece
Clamping table joke DS 300, without base plate			
	With clamping plate plate Ø 300 mm with grid holes M10 and receiving holes for magnets	0 200 300-1	2564.00 €
	Rotation range: 360° manual Pivoting range: 0 – 100° through gearing mechanism Weight: approx. 28 kg		

Accessories / spare parts

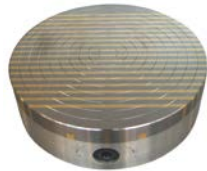
	Dimensions	Weight	Clamping force	Pole pitch	Order No.	Price from 1 piece
Round magnets for joke DS 300 clamping table						
	Ø 160 x 75 mm	9 kg	120 N/cm ²	6 + 1.5 + 2 + 1.5	0 200 314	917.00 €
	Ø 200 x 80 mm	13 kg	120 N/cm ²	8 + 5	0 200 313	1187.00 €
	Ø 250 x 80 mm	20 kg	120 N/cm ²	8 + 5	0 200 312	1391.00 €
	Ø 300 x 85 mm	29 kg	120 N/cm ²	8 + 5	0 200 310	1993.00 €

Positioner joke Junior

Positioner joke Junior

For flexible polishing of smaller workpieces: the ball joint can be rotated in all directions and fixed with a clamping lever. In addition, the magnet can be rotated by 360° and fixed using a clamping lever.

	Order No.	Price from 1 piece
Positioner joke Junior		
Freely rotatable ball joint, rotation range magnet: 360° Magnet dimensions: Ø 125 x 48 mm Pivot range: 0 – 55°	0 200 049	612.00 €

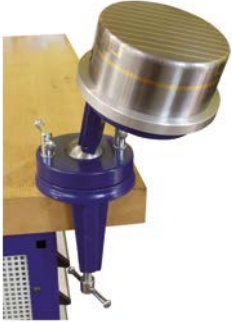

ball joint vices JUNIOR

	Design	Order No.	Price from 1 piece
JUNIOR ball joint vices			
 <p>JUNIOR ball joint vice with rippled hardened steel jaws. For clamping to worktops up to 75 mm thick. Jaw width: 80 mm Clamping length: 65 mm Clamping depth: 50 mm Inclination: ± 50°</p>	for clamping	0 200 055	129.60 €
	for screwing in position	0 200 056	118.20 €

Precision grinding and control vices

Ground on all sides for 4-side processing, hardened steel, with prism jaws, draw-down clamping system, accuracy 0.005 mm.

	Jaw widths	Clamping length	Jaw height	Dimensions	Order No.	Price from 1 piece
Precision grinding and control vice						
	25 mm	20 mm	9 mm	29 x 65 mm	0 200 341	48.40 €
	48 mm	70 mm	25 mm	50 x 140 mm	0 200 342	80.30 €
	63 mm	87 mm	32 mm	63 x 175 mm	0 200 343	96.50 €



Magnetic clamping balls joke Magic-Ball

Magnetic clamping balls joke Magic-Ball

Comfortable and ergonomic 3-dimensional work. Ideal for polishing and welding workplaces. The Magic-Ball magnetic clamping balls bring your workpiece into almost any desired position. Depending on the workpiece geometry and weight, pivoting angles of up to 90° can be set. The balls are enclosed in leather-lined, chemically nickel-plated steel rings that hold them absolutely securely in any position – the sliding adhesion effect makes it possible! The powerful magnetic chuck of the Magic-Ball is activated using the key supplied (partial activation is also possible for optimum positioning of the workpiece). The balls available in four sizes are all of “Made in Germany” quality.





Non-magnetic components are clamped...
using the precision vices also available from us. Fixing of the components upright is therefore also possible.
More informations on page 458.

	Dimensions	Clamping force	Pole pitch	Weight (kg)	Order No.	Price from 1 piece
Magnetic clamping balls joke Magic-Ball						
	magnet (Ø): 80 mm ball (Ø x H): 128 x 104 mm	80 N/cm ²	1.5 + 0.5 mm	ball: 4 kg ring: 1 kg	0 200 323	789.00 €
	magnet (Ø): 100 mm ball (Ø x H): 158 x 129 mm	100 N/cm ²	1.5 + 0.5 mm	ball: 7 kg ring: 2 kg	0 200 324	956.00 €
	magnet (Ø): 130 mm ball (Ø x H): 188 x 145 mm	100 N/cm ²	1.5 + 0.5 mm	ball: 11 kg ring: 4 kg	0 200 325	1176.00 €
	magnet (Ø): 160 mm ball (Ø x H): 218 x 164 mm	100 N/cm ²	1.5 + 0.5 mm	ball: 17 kg ring: 5 kg	0 200 326	1384.00 €



The magnetic chuck is activated using the key supplied

Vices

		Design	Order No.	Price from 1 piece
Rotating and reversible clamp 1 B				
	For clamping to workbenches up to 80 mm thick.		with plastic jaws	0 200 002
	Jaw width:	46 mm		
	Clamping length:	50 mm		
	Clamping depth:	35 mm		
Rotating and reversible clamp 2 B				
	For clamping to workbenches up to 80 mm thick.		with aluminium jaws	0 200 015
	Jaw width:	80 mm		
	Clamping length:	100 mm		
	Clamping depth:	52 mm		

Accessories / spare parts

	Order No.	Price from 1 set
Rotating and reversible clamp 1 B		
Replacement plastic jaws, pair	0 200 030	15.50 €
Replacement aluminium jaws, pair	0 200 031	15.50 €
Rotating and reversible clamp 2 B		
Replacement plastic jaws, pair	0 200 032	43.30 €
Replacement aluminium jaws, pair	0 200 033	43.30 €

Engraving Ball

unlimited clamping options

NEW!
Engraving Ball

This engraving ball has a painted, non-reflecting surface. It provides unlimited clamping options for holding tools securely. It also has holes for mounting additional tools. The upper part has an adjustable brake, which allows it to be either fixated or rotated around its own axis. The ball has a stable seating, but can still be swiveled in all directions. The centrally adjustable, self-centering jaws with prisms also enable round workpieces to be clamped.

	Dimensions	Order No.	Price from 1 piece
Engraving Ball	Ø 150 mm	0 200 329	486.00 €



The engraving ball has a maximum opening of 85 mm. The wide range of accessories includes: upper part with locking brake, including clamping key, 2 mounting plates, rubber pads, 4 pins and a 30-part set of accessories.



Scope of delivery



Felt-padded retaining accessory



Mould jaws made of modelling granulate

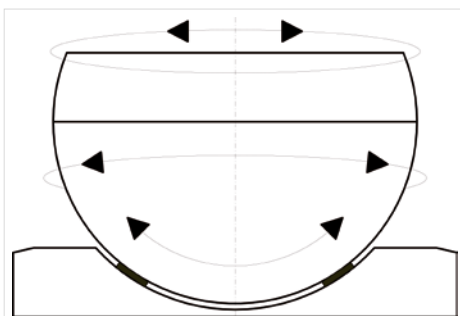

- Ball freely rotatable and pivotable
- Top section rotatable through 360°

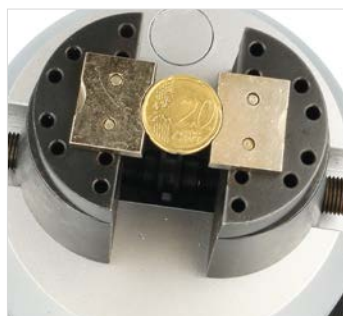

Retaining accessory for flat, round components



Mounting via retaining pins

Illuminated magnifying glass

LED illuminated magnifying glass

LED illuminated magnifying glass

A classic meets high technology. 64 LED's create a fantastically bright light while saving power and have a very long life. 2.25 x magnification can be achieved with the real glass, 5-dioptre magnifying glass. The flexible, 860 mm-long articulated arm rapidly brings the magnifying glass into any desired working position. We have something else for you in addition to all the technical highlights: the price.

	Order No.	Price from
LED illuminated magnifying glass	0 200 575	124.95 €
Equipment:	64 LED's	
Colour temperature:	6,400 K	
Material Head:	plastic	
Material articulated arm:	steel tubing	
Articulated arm range:	860 mm	
Lamp cover:	Plastic shade	
Lens dimensions:	Ø 145 mm	
Lens dioptre:	5	
Magnification:	2.25 x	
Connection:	230 V, 50/60 Hz	
Weight:	3 kg	
Clamping range:	0 – 65 mm	



64 LED's for optimum,
energy-saving illumination



Illuminated magnifying glass

Magic touch

LED illuminated magnifying glass Magic touch

More light per watt. 63 innovative LEDs ensure optimal light conditions with minimised energy usage. Next advantage: service life of at least 50,000 working hours. That means six years of light non stop without any maintenance costs. The show-stopper is the operation via the touch sensor integrated in the lamp head. A gentle touch is enough to turn the light on and off. Thanks to the high tech optics, the light is precisely focussed and light loss through scattering is drastically reduced. The plastic lens (Ø 72 mm) has a power of 6 dioptries, which means 2.3x magnification of the viewed objects. The lens has a hard coating to prevent scratches. The highquality lens protection cover shields the lens against damage during work breaks. The lamp can optionally be fixed directly onto the workplace with a plastic foot and four screws, or attached using the table clamp available as an accessory.

	Order No.	Price from 1 piece
LED illuminated magnifying lamp Magic touch		
	0 200 568	422.00 €
Equipment:	63 LEDs	
Colour temperature:	4,300 K, neutral white	
Swan neck:	400 / 233 mm (flexible/fixed)	
Lamp service life:	At least 50,000 h	
Dimensions of head/lens:	Ø 122 / Ø 72 mm	
Dioptre lens:	6	
Connection:	100 – 240 V, 50/60 Hz	





63 LEDs for as much light per watt

Flexible swan neck for perfect positioning above the material to be tested



⚙️ Accessories / spare parts

	Order No.	Price from 1 piece
Magnetic base Ø 85 mm		
	Suitable for LED magnifying glass Magic touch (0 200 568)	0 200 556 68.70 €
Magnetic support plate 90 x 85 mm		
	Suitable for table clamp (0 200 561)	0 200 542 24.00 €
Table clamp		
	clamping range 0 – 65 mm	0 200 561 32.95 €

7

Illuminated magnifying glass Panorama

Illuminated magnifying glass Panorama

The light with a panoramic view. Extra wide field of vision thanks to the XXL lens (190 x 157 mm). It therefore offers the widest field of vision of all the illuminated magnifiers in our range. With the 1.75 x enlargement (3 dioptre lens), objects appear 75 % larger under the illuminated magnifying glass.

The comfortable distance of 330 mm gives you enough (free) space to work under the illuminated magnifying glass.

The two fluorescent lamps mounted to the left and right of the magnifier offer daylight quality (6,400 K). The scratch-resistant plastic casing is mounted on a steel pipe articulated arm, which can be placed flexibly in any position you wish. Supplied with plastic table clamp: optionally a steel table clamp for a particularly strong hold is available.

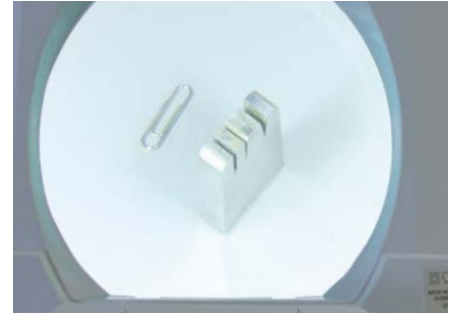

- XXL lens for an extra large field of vision
- Day light quality 6,400 K
- Top price/performance ratio
- Flexible fastening possibilities in the workplace



Extra large field of vision thanks to XXL lens

		Order No.	Price from 1 piece
Illuminated magnifying glass Panorama			
	Equipment: 2 x compact fluorescent lamps 9 W Colour temperature: 6,400 K Material Head: plastic Material articulated arm: Steel pipe Articulated arm reach: 880 mm Lamp cover: Plastic shield Lens dimensions (W x D): 190 x 157 mm Dioptre lens: 3 Magnification: 1.75 x Connection: 230 V, 50/60 Hz Weight: 4.9 kg	0 200 572	230.00 €

⚙️ Accessories / spare parts

		Order No.	Price from 1 piece
Steel table clamp			
	for especially strong hold on the table	0 200 573	68.45 €
Spare fluorescent lamp (6,400 K)			
		0 200 574	8.40 €

Illuminated magnifying glass LED Premium

Illuminated magnifying glass LED Premium

This illuminated magnifying glass is characterised by several special features

- A wide range of action – even large workpieces can be observed
- A mobile magnifying glass unit – workpieces can be observed from any angle
- energy-saving, energy efficiency class A+
- separately switched LED-light segments cause a 3D shade effect that are focused on their structure, this focus shows small errors and differences in the surface structure of an object
- A distortion-free field of vision allows optimum work under the magnifying glass
- Screw-fit lamp foot
- Ground lens made of optical glass



	Order No.	Price from
		1 piece

Illuminated magnifying glass LED Premium		Order No.	Price from
Equipment:	LED's, energy efficiency class A+	0 200 560-LED	587.00 €
Colour temperature:	4,000 K		
Mains connection cable:	ca. 3 m, earthing plug		
Material:	steel tubing, powder-coated		
Articulated arm range:	700 mm		
Light output:	LED-light segments switchable in multi stages		
Lamp cover:	shade, matt		
Joint relief:	spring		
Pivoting range:	60° / 310°		
Rotation range:	360° magnifying glass		
Protection class:	I		
Protection:	IP 20		
Power input:	about 12 W		
Dimensions of lens:	162 x 105 mm		
Dioptries, lens:	3		
Supply voltage:	220 – 240 V / 50/60 Hz		
Weight:	approx. 4.5 kg		
Colour:	RAL 7035		
Specific features:	light segments can be switched separately, excellent colour reproduction, RA > 95		



Good to know!

Diopte

denotes the power of refraction of the lens. This value also determines the ratio between the magnification factor and the focal distance.

Focal distance

is the distance between the centre of the magnifying glass and the object observed, at which no distortion occurs.

Magnification factor

is the degree of magnification of the object observed.

How is the magnification calculated?

The following formula can be used to calculate the magnification factor:

$$\frac{\text{No. of diopter}}{4} + 1 = \text{magnification factor}$$

$$\frac{4}{4} + 1 = 2$$

The illuminated magnifying glass therefore corresponds to a magnification of:

$$\frac{3}{4} + 1 = 1,75$$

Some further useful tips:

- The focal length and size of the lens decrease with increasing magnification.
- In order to achieve maximum, distortion-free magnification, hold the magnifying glass approx. 25 cm from your eyes.

⚙️ Accessories / spare parts

	Order No.	Price from
		1 piece

Table clamp

clamping range 0 – 65 mm

0 200 561

32.95 €



Clip-on magnifying glass

for clipping to illuminated magnifying glass, lens 4 dioptries, allowing total magnification to 7 dioptries, dimensions: 162 x 105 mm

0 200 562

151.00 €



Workplace light LJ 1

LED version

	Order No.	Price from 1 piece
--	-----------	-----------------------

LED workplace light LJ 1



Detailed view of lamp head and housing.
Wide beam or spotlight infinitely adjustable.

- Light beam continuously adjustable from wide beam (36°) to spotlight (10°)
- Even places that are difficult to reach can be illuminated
- Brighter than a 50 W halogen light with 80 % reduced power consumption
- Flexible, plastic-coated, metal light holder tube (700 mm)
- Switch integrated in light head
- Cooling star and focus made of aluminium (anodised)
- Lamp head and housing made of plastic (oilproof, impactproof, non-inflammable)

0 200 526-7

314.00 €

Technical data:

Equipment:	3 watt-high-power LEDs
Colour temperature:	6,000 K
Luminosity:	50,000 lux (spotlight) 6,000 Lux (wide beam)
Angle of reflection:	10° to 36° infinitely adjustable
Bulb life:	35,000 h
Connection:	110 – 240 V, 50/60 Hz
Protection class:	IP 20
Scope of supply:	Lamp incl. plastic table clamp and magnetic base

Accessories / spare parts

	Order No.	Price from 1 piece
--	-----------	-----------------------

Magnetic base Ø 80 mm



Suitable for workplace light HJ 1 (0 200 533), workplace light KJ 1 (0 200 534), LED workplace light LJ 1 (0 200 526-7) and LED cold light lamp JS 4 (0 200 523)

0 200 535

39.90 €

Workplace light KJ1 Cold light version

 Price from
1 piece

Order No.

Workplace light KJ1 – cold light, 11 W



- robust 700 mm metal articulated tube (coated) for free mobility of the lamp head with high positional stability
- fluorescent tube (11 W) for soft, low-shadow and dazzle-free light
- rotatable lamp head

0 200 534

164.00 €

Technical data:

Equipment: 1 x fluorescent tube, 11 W
 Colour temperature: 3,000 K
 Luminosity: 1,150 lux
 Bulb life: approx. 8,000 h
 Connection: 230 V, 50/60 Hz
 Cable length: 3 m with moulded contoured plug
 Protection class: IP 40
 Scope of delivery: lamp incl. plastic table clamp

Workplace light HJ1 Halogen version

 Price from
1 piece

Order No.

Workplace light HJ1 – halogen, 20 W



- robust 600 mm metal articulated tube (coated) for free mobility of the lamp head with high positional stability
- with protective glass cover

0 200 533

137.15 €

Technical data:

Equipment: 1 x halogen bulb, 20 W
 Colour temperature: 2,800 K
 Luminosity: 3,850 lux
 Angle of reflection: 36°
 Bulb life: approx. 2,000 h
 Connection: 230 V, 50/60 Hz
 Cable length: 3 m with moulded contoured plug
 Protection class: IP 20 (also available in IP 54!)
 Scope of delivery: lamp incl. plastic table clamp and protective glass cover

Also available as spotlight with an angle of reflection of 10°!

Modeling granules easily applicable

The plastic already becomes soft and ductile at 60 °C. Add the granulate to warm water at max. 65 °C. As soon as the granulate has become completely transparent, it can be removed from the water and shaped with the hand. Once completely cooled, the plastic is hard but not brittle.

	Order No.	Price from 1 piece
Modeling granules		
Content: 1 kg	0 960 071	26.55 €



Raw granulate



Mould jaws



Mobile phone holder



Moulding



Drilling device



Tool handles

Precision impression silicone

Provil Novo Light CD 2

Precision impression silicone

Provil Novo Light CD 2

Work in narrow slots and bore holes is already tricky enough in itself. Yet how can you expect to assess the results if you can hardly see anything during processing? Very simply: with Provil Novo Light CD 2 precision impression silicone.

Behind the somewhat unwieldy name is a very free-flowing silicone that reaches practically everywhere. A precise and fine impression (impression accuracy: <math>< 0.1 \mu\text{m}</math>) of even the most difficult geometrical shapes is achieved, even overhead.

The application system guarantees an absolutely constant mixing ratio for safe, error-free use: the silicone is evenly expelled from both chambers of the double cartridge by means of a mixing gun and through the mixing canula and is directly applied to the object. Mixing canula attachments can be used in addition for minute cavities.

The advantages at a glance:

- Exact replicas with maximum impression accuracy (<math>< 0.1 \mu\text{m}</math>)
- Extremely simple use without prior knowledge owing to the application system
- No heat generation during use (therefore no influence on the surface characteristics)
- Limited time expenditure + economical
- No hazardous substances, no health and safety risk



	Order No.	Price from 1 piece
Provil Novo Light CD 2 precision impression silicone		
 2 x double cartridges (50 ml respectively) incl. 12 mixing canulas	0 960 041	39.40 €

↓ matching set



	Order No.	Price from 1 set
Starter set, Provil Novo Light CD 2 precision impression silicone		
2 x silicone incl. mixing gun, mixing canulas (12 pcs.) and attachments (8 pcs.)	0 960 040	97.10 €

⚙️ Accessories / spare parts



	Order No.	Price from 1 pack	1 piece
Mixing gun			
suitable for Provil Novo Light CD 2 double cartridge	0 960 042		58.85 €
Mixing canula attachments (8 pieces)			
narrow/curved, for filling very fine slots	0 960 043	2.49 €	
Replacement mixing canulas (12 pieces)			
Replacement mixing canulas for Provil Novo Light CD 2 double cartridge	0 960 044	8.20 €	

Cutting oils and pastes, separating agents and sprays

Universal cutting oil Solis Ambo N3S

- Mineral oil-free, chlorine-free, skin-friendly
- Based on sustainable raw materials
- Excellent for drilling, thread cutting, reaming, groove broaching, tapping, turning and milling
- For all alloyed and non-alloyed steels, chrome nickel, titanium, manganese, copper and its alloys

	Content	Order No.	Price from 1 piece
Universal cutting oil Solis Ambo N3S			
	500 ml spray bottle	0 960 400	12.75 €



Cutting oil foam Solis Ambo N4G

- Foam with very good adhesive properties for economical processing
- Mineral oil-free, chlorine-free, skin-friendly
- Excellent for drilling, thread cutting, reaming, groove broaching, tapping, turning and milling
- For all alloyed and non-alloyed steels, chrome nickel, titanium, manganese, copper and its alloys

	Content	Order No.	Price from 1 piece
Cutting oil foam Solis Ambo N4G			
	400 ml aerosol	0 960 401	13.05 €



High performance cutting oil Solis Ambo M5S

- Increased viscosity for difficult machining tasks
- Chlorine-free
- Excellent for drilling, thread cutting, reaming, groove broaching, tapping, turning and milling
- For all alloyed and non-alloyed steels, chrome nickel, titanium, manganese, copper and its alloys

	Content	Order No.	Price from 1 piece
High performance cutting oil Solis Ambo M5S			
	500 ml spray bottle	0 960 402	12.65 €



Cutting oils and pastes, separating agents and sprays

Thread cutting paste Solis Pina V4G

- The paste for extremely difficult working processes in which liquid oils do not provide any satisfactory results
- Chlorine-free and odourless
- Excellent for drilling, thread cutting, reaming, groove broaching, tapping, turning and milling
- For rust-free and heat-resistant alloys, molybdenum, manganese, chrome nickel steel, VA and titanium

	Content	Order No.	Price from 1 piece
Thread cutting paste Solis Pina V4G			
	750 g can	0 960 403	23.30 €

Universal oil BALLISTOL

Uniquely versatile and environment-friendly at the same time. This oil cares, lubricates, disinfects, protects against rust, creeps into the minutest corners, has a very low friction coefficient and does not resinify. With all these superb qualities, the oil is fully biodegradable, food-grade, skin-friendly and completely harmless.

Use in industry, trade, hobby and soon with you too.

	Content	Order No.	Price from 1 piece
Universal oil BALLISTOL			
	200 ml aerosol	0 960 601	7.80 €

Universal cleaner Luxan Clean Uni

- Highly concentrated water-based cleaner
- Dilutable up to 1:40
- Dissolves heavy soiling in seconds
- For removing oil, grease and protein soiling
- For machines and surfaces made of metal, plastic, ceramic and many more

	Content	Order No.	Price from 1 piece
Universal cleaner Luxan Clean Uni			
	500 ml hand sprayer	0 960 404	15.70 €

Sprays

Mould separating agent FT 73

This silicone-free lubricant and separating agent makes demoulding child's play. The combination of high quality active ingredients results in a high lubricating effect and effectively prevents adhesion to plastics, moulds, metals and tools. The spray consists of pure natural products and is heat-resistant between -20°C to $+130^{\circ}\text{C}$.

	Content	Order No.	Price from	
			1 piece	
Mould separating agent FT 73				
	400 ml aerosol	0 960 600	7.30 €	



Cleaning fluid X 73016-A

For all metals, glass, ceramic and many plastics. Use: cleaning moulds, cleaning machine components, pretreatment of glue points, pretreatment for lacquering. The spray cleaner rapidly evaporates and works without leaving residues. Unlike during use of solvent, no residual layer is left behind. Even removes resinated lubricants. Thermoplastics such as PVC, Plexiglas, polystyrene and simple paint strokes can be dissolved.

	Content	Order No.	Price from		
			1 piece	5 pieces	12 pieces
Cleaning fluid X 73016-A					
	500 ml aerosol	0 580 521	6.75 €		6.05 €
	5 l container	0 580 522	43.50 €	38.75 €	
	30 l container	0 580 523	242.00 €		



Sprays

Cleaning fluid X 73020

Finds applications in industry and workshop areas. Owing to its special formula, the spray combines corrosion protection, cleaning, water repellence, lubrication and preservation in a single product. The spray dissolves rust, repels moisture, eliminates squeaking noises, cleans soiled surfaces, protects and cares for all tools and can also do farmuch more. A genuine all-round performer that no workplace should be without.

	Content	Order No.	Price from	
			1 piece	12 pieces
Cleaning fluid joke X 73020	400 ml aerosol	0 580 526	5.45 €	4.95 €



Corrosion protection X 73030

With a composition based on synthetic wax and special additives, this spray offers both temporary corrosion protection and preservation of uncoated bright metals. Adheres to all metal surfaces, leaving behind a tacky, flexible protective film, free of silicone or silicone-based products. Seawater-resistant and therefore also suitable for corrosion protection during shipping by sea for example. Ideal for preserving stock items (injection moulds, etc.) and precision components, tools, etc.

	Content	Order No.	Price from	
			1 piece	12 pieces
Corrosion protection X 73030	400 ml aerosol	0 580 525	8.10 €	7.60 €



Sprays

Aluminium grinding spray X 73050

The low degree of hardness of aluminium and other non-ferrous metals can lead to clogging of the pores of the processing tool. The simple use of this aluminium grinding spray prevents this and leads to improved stock removal (by up to 350 %!). At the same time, the spray cools the material and reduces the shearing forces during processing. Suitable for use with all grinding media on a base, such as abrasive discs, sleeves, strips etc.

	Content	Order No.	Price from	
			1 piece	12 pieces
Aluminium grinding spray X 73050				
	400 ml aerosol	0 580 529	8.75 €	8.35 €



Diamond compound cleaner joke Magic

This cleaner which is universally usable for all diamond compounds cleans the workpieces without leaving streaks after polishing. Can also be used for cleaning lapped workpieces. The spray is oil and silicone-free and therefore has a very discreet odour. Simple handling with simultaneously high cleaning power make the cleaner indispensable for any polisher.

	Content	Order No.	Price from	
			1 piece	12 pieces
Diamond compound cleaner joke Magic				
	500 ml aerosol	0 590 610	12.75 €	11.10 €



Spray bottles for decanting cleaners and other liquids

Spray bottles

for transferring cleaners and other liquids from large containers. Particularly suitable for diamond fluids or lapping fluids such as diamond suspensions soluble in oil or water.



	Order No.	Price from 1 piece
Pump spray bottle, 250 ml	0 580 455	9.80 €
Spray bottle, 100 ml	0 580 515-2	7.65 €
Spray bottle, 500 ml	3 645 600	6.70 €

Waste bags

Waste bags

- Extra strong and tear-resistant
- draw-string
- Two sizes (70 and 120 litres)

Capacity	Content	Order No.	Price from 1 piece
Waste bags			
70 l	1 roll (25 bags)	0 960 458	3.94 €
120 l	1 roll (25 bags)	0 960 459	4.79 €



Protection for the ears

Headband earplugs

These earplugs are securely held in position by the plastic headband – even in case of rapid or jerky movements. They sit comfortably and pleasantly in the ears and the surrounding volume is reduced by 24 decibels (dB).

	Order No.	Price from 1 piece
Headband earplugs	0 960 723	3.08 €



Super-Fit earplugs incl. box

These tiny earplugs fit so well in your ears that you will probably hardly notice them. In contrast, the astonishing ability to understand speech will be all the more apparent, even though the surrounding volume is reduced by 30 decibels (dB). Supplied with a practical storage box (incl. belt clip) and safety cord.

	Order No.	Price from 1 piece
Super-Fit earplugs incl. box	0 960 724	2.16 €



Protection for the eyes

Protective goggles

- Clear, optically correct, single-piece PC pane
- Scratchproof coating
- casual design, extremely light (21.5 g)
- Protection against general hazards and flying particles (up to 45 m/sec.)
- Comfort pads on the temple ends
- Soft nose pad

	Order No.	Price from 1 piece
Protective goggles	0 203 083-1	5.40 €



Protection for the lungs

Fine dust masks



Fine dust masks

Professional protection against solid and liquid particles, fine dusts and even smog. High quality valve technology ensures a fresh climate under the mask, since warm, moist expired air is vented to the exterior.

The innovative filtering allows on the one hand greater protection and at the same time facilitates breathing when the mask is applied. The masks are comfortably and safely positioned owing to the preformed mask bodies and the flexible nose pads. The FFP3 model is equipped with a foam sealing lip and therefore sits even more comfortably and tightly in place. Additional protection provided by activated charcoal against organic gases and acid vapours.

Application areas:

- FFP2 up to 10 times the MAK limit value
- FFP3 up to 30 times the MAK limit value

	Packing quantity	Order No.	Price from 1 piece
Fine dust mask FFP2 with activated charcoal + expiration valve	10 pieces	0 960 721-0	1.48 €
			
Fine dust mask FFP2 with expiration valve	10 pieces	0 960 720-0	1.31 €
			
Professional fine dust mask FFP3 with expiration valve	5 pieces	0 960 722	2.60 €
			



FFP2

FFP2 with activated charcoal

FFP3

Protection for the eyes

Protective goggles with progressive lenses

Protective goggles JK 16 with progressive lenses

Finally a pair of protective goggles with progressive lenses – that is what the JK 16 from joke offers, making them a good alternative to the “second pair of spectacles” for age-related long-sightedness.

The JK 16 is available in 6 strengths for optimum compensation of visual impairment. With 1.0 to 3.5 dioptres, the spectacles offer maximum wearing comfort coupled with optimum protection.

Special features:

- Progressive lenses certified according to EN166 FT.
- Closed side protection with ventilation slots and treatment of the lenses with an antifog coating permanently guarantee a clear view.
- The temples are variable in angle and adjustable in length for optimum wearing comfort.
- These protective goggles weigh a mere 44 g for a strength of +2.5 dioptres and offer overall the optimum prerequisites for fatigue-free work.

Scope of delivery:

- Microfibre case
- Spectacle cord (according to EN166)

	Maximum correction in the bottom part of the lenses	Moderate correction in the centre of the lenses	Minimal correction in the top part of the lenses	Order No.	Price from 1 piece
Protective goggles JK 16 with progressive lenses					
	1.0 dioptres	1.0 dioptres	0.3 dioptres	0 960 750	49.35 €
	1.5 dioptres	1.2 dioptres	0.7 dioptres	0 960 751	49.35 €
	2.0 dioptres	1.4 dioptres	0.7 dioptres	0 960 752	49.35 €
	2.5 dioptres	1.9 dioptres	1.2 dioptres	0 960 753	49.35 €
	3.0 dioptres	2.3 dioptres	1.4 dioptres	0 960 754	49.35 €



Hand care

Sandexon ULTRA hand washing cream

Beige-brown, medium paste consistency, lemon-scented. This cream easily lathers, dissolves rapidly in water, does not smear and does not block drains. Yet it seemingly effortlessly removes even heavy soiling from your skin while at the same time protecting against recontamination. Incidentally, guaranteed free of sand or sawdust among the ingredients – but with skin-friendly synthetic scrubbing agents instead. Owing to its excellent cleaning power, Sandexon ULTRA can be used very sparingly.

Content	Order No.	Price from 1 piece
Sandexon ULTRA hand washing cream		
500 ml pot	0 960 731	2.68 €
Sandexon ULTRA hand washing liquid		
2 l bottle	0 960 732	10.35 €



⚙️ Accessories / spare parts

	Order No.	Price from 1 piece
Dispensing pump		
	0 960 733	28.95 €
Wall holder		
	0 960 734	27.50 €

Industrial paper

Industrial paper

This high-quality blue paper towelling absorbs almost anything, particularly readily and effectively dirt, oils and greases ... highly absorbent and tear-resistant. Supplied on a roll of 1,000 sheets (roll length 360 m). Matching floor stands and wall holders as accessories.

	Order No.	Price from 1 piece
Industrial paper roll, 3-layer		
	0 960 450	28.40 €



⚙️ Accessories / spare parts

	Order No.	Price from 1 piece
Floor stands		
made of metal, blue lacquered Dimensions: 460 x 900 x 440 mm (W x H x D)	0 960 456	42.75 €
Wall holder		
made of metal, blue lacquered Dimensions: 500 x 312 x 230 mm (W x H x D)	0 960 457	39.60 €



Rotating tool holder brings tidiness to your workplace

			Order No.	Price from 1 piece
Rotating tool holder				
Rotating tool holder from joke: everything within easy reach			0 200 020	19.90 €
<p>Every desired tool is always at hand. Eliminates tiresome searching for the right implement. The rotating tool holder allows accommodation of more than 10 tool units. All the essential utensils for surface finishing (or other working stages) are in one place.</p> <p>The following items are available overall:</p> <ul style="list-style-type: none"> • 92 receptacles for tools with a Ø 3 mm or 1/8" shank • 13 receptacles for tools with a Ø 6 mm or 1/4" shank • 7 receptacles for different drills • internal receptacle for tools, Ø 70 x 75 mm deep • Dimensions: Ø 165 mm x 102 mm 				



Surface protection

Surface protection film

The simplest way of protecting scratch and dirt-sensitive surfaces during further processing, transport or storage. This film is fixed to the workpiece like an adhesive tape and can be detached again, above all absolutely without leaving residues. Suitable for steel, copper, anodised aluminium and glass, etc. Heat-resistant between -20 °C and +60 °C.

				Order No.	Price from 1 piece
Width	Total length	Thickness			
Surface protection film					
250 mm	100 m	50 µm	0 960 380	39.40 €	



Hand cleansing cloths

Hand cleansing cloths

For mobile hand cleansing; also for cleaning tools and surfaces, without aggressive solvents and alcohol.

- Highly efficient and effective cleaning of contamination by oils, lubricating greases, wet paints, adhesive, ink, petrol, etc.
- Simple to use, ideal when out and about and wherever no water is available.
- Large cloths (25 cm x 25 cm) in a resealable bucket
- Provided with an abrasive cloth side for improved cleaning performance.

	Content	Order No.	Price from	
			1 piece	5 pieces
Hand cleansing cloths	70 cloths	0 960 735	10.45 €	10.10 €



Universal liquid-absorbent mat

Universal liquid-absorbent mat

It mops everything up. Your workplace should no longer be without this mat if you work with oils, lubricants and chemicals. In this way, you can simply and effectively protect floors and working surfaces for example during cleaning, machine repairs and lining tool drawers, etc.

The highly absorbent mat can absorb a tidy 0.86 litres per cloth. It consists of polypropylene and fine fibre layers; a PE film on the back protects against soaking through. Important: the mats are absolutely lint-free.

Application areas: workshops, laboratories, hobby (car, motorcycle), household (oil heating, lawnmower, chainsaw ...).

	Dimensions	Packing quantity	Order No.	Price from
				1 pack
Universal liquid-absorbent mat	430 x 480 mm	10 pieces	0 960 500	15.30 €



Maschine leaks



Use of sprays



Ultrasonic cleaning



Polishing wool

If it is good for human skin, it cannot fail to be right for technical surfaces. Cotton wool is a universal cleaning aid. A choice between cotton and viscose (rayon) in addition to a "50/50 blend" of both is available. Rayon very rapidly absorbs liquid, whereas cotton stores it longer and offers better cohesion of the fibres. Cotton wool pads (100% cotton) are available in addition to the loose cotton wool balls.

Design	Material	Content	Order No.	Price from 1 pack
Polishing wool				
	Cotton wool	50 % viscose / 50 % cotton	100 g in the bag	0 960 010 2.27 €
		100 % cotton	100 g in the bag	0 960 011 2.27 €
		100 % cotton	250 g in the bag	0 960 012 4.80 €
		100 % viscose	180 g in the bag	0 960 013-1 2.24 €
Cotton wool pads	100 % cotton	40 pieces in the bag	0 960 015	1.62 €

Polishing cloths Kleenex

High quality 3-ply cloth for wiping after polishing and for applying joke Magic very fine polishing suspension (similar illustration).

Design	Content	Colour	Dimensions	Order No.	Price from 1 piece
Polishing cloths Kleenex					
3-ply	72 cloths	white	20 x 20 cm	0 590 602	2.20 €



Cleaning stick

NEW!

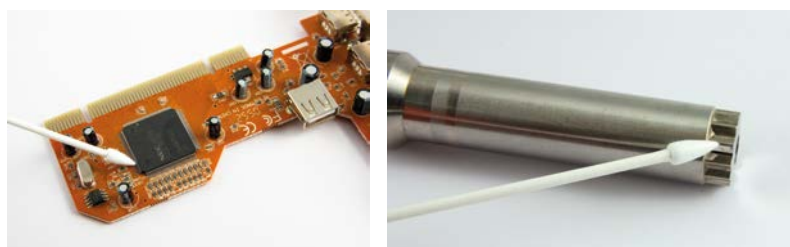

The lint-free cleaning sticks are highly absorbent and owing to their pointed shape, ideal for use in model and mould making as well as in areas such as optics, laser and microtechnology. The rods have a very dense and firm head made of highest-quality cotton. They are therefore super absorbent, suitable for solvents and retain their shape when wet. Perfect for all cleaning tasks in hard-to-reach areas or for precise application of liquids (e. g. adhesives, resins, alcohols).

	Packing quantity	Order No.	Price from 1 pack
Cleaning stick			
	100 pieces	0 960 003	11.95 €



Cleaning wires

Flexible and firm at the same time. Particularly suitable for detaching and removing simple soiling in the drilling holes. Trimming made of soft cotton, with and without incorporated bristles (for maximum cleaning power). The wires are resistant against cleaning media and can be used both wet and dry. Available in long (150 mm) and longer (300 mm), conically wound respectively.

	Material	Dimensions	Packing quantity	Order No.	Price from 1 pack
Cleaning wires					
	Cotton wool without bristles	Ø 4/5 x 150 mm	80 pieces	0 960 005	2.30 €
	Cotton wool with bristles	Ø 4/5 x 150 mm	80 pieces	0 960 006	2.96 €
		Ø 3.5/5.5 x 300 mm	50 pieces	0 960 007	4.70 €



Cotton wool without bristles



Cotton wool with bristles

Cotton buds

Familiar in principle to any child. The joke cotton buds have a very dense and firm cotton wool head trimming (small and large version available). With their long wooden shanks, they are markedly superior to PP sticks, since more rigid and resistant to cleaners. Furthermore, their diameter also fits in the collets of our handpieces. Use wet or dry for cleaning and with compound for polishing.

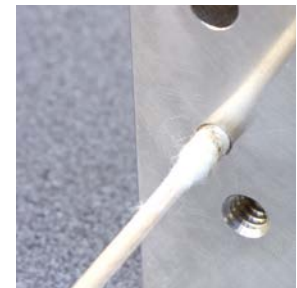

	Design	Dimensions	Packing quantity	Order No.	Price from 1 pack
Cotton buds on wooden sticks					
	small head (Ø approx. 4 – 5.5 mm)	Ø 2.3 x 150 mm	100 pieces	0 960 001	10.75 €
	large head (Ø approx. 10 – 12 mm)	Ø 3 x 200 mm	50 pieces	0 960 002	10.95 €



Precision gauge tapes

individual and as assortments with sheet sections

Precision gauge tapes and reference sheets

The precision gauge tapes and reference sheets are used for example when dressing moulds and tools, compensating tolerances and readjusting the bearing play of guides and cutting blades, adjustment of devices, etc., etc.

The tapes are supplied in hardened springband steel (material no. 1.1274) or Cr-Ni steel.

In addition to this standard selection, we supply you on request and at short notice tapes and cut sections in widths of up to 300 mm made of different materials such as C steel, stainless Cr-Ni steel and brass.

	Thickness	Width	Total length	Material	Order No.	Price from 1 piece	
Precision gauge tape							
	0,005 mm	12.7 mm	5 m	1.4310	0 960 300	49.65 €	
	0,01 mm	12.7 mm	5 m	1.4310	0 960 301	33.95 €	
	0,02 mm	12.7 mm	5 m	1.4310	0 960 302	22.90 €	
	0,03 mm	12.7 mm	5 m	1.1274	0 960 303	10.75 €	
	0,04 mm	12.7 mm	5 m	1.1274	0 960 304	10.20 €	
	0,05 mm	12.7 mm	5 m	1.1274	0 960 305	9.70 €	
	0,06 mm	12.7 mm	5 m	1.1274	0 960 306	7.80 €	
	0,07 mm	12.7 mm	5 m	1.1274	0 960 307	7.30 €	
	0,08 mm	12.7 mm	5 m	1.1274	0 960 308	7.05 €	
	0,09 mm	12.7 mm	5 m	1.1274	0 960 309	7.05 €	
	0,10 mm	12.7 mm	5 m	1.1274	0 960 310	6.75 €	
			150 mm	5 m	1.4310	0 960 332	62.75 €
	0,12 mm	12.7 mm	5 m	1.1274	0 960 311	7.05 €	
	0,15 mm	12.7 mm	5 m	1.1274	0 960 312	7.05 €	
	0,18 mm	12.7 mm	5 m	1.1274	0 960 313	7.15 €	
	0,20 mm	12.7 mm	5 m	1.1274	0 960 314	7.15 €	
			150 mm	5 m	1.4310	0 960 333	78.55 €
	0,25 mm	12.7 mm	5 m	1.1274	0 960 315	7.50 €	
	0,30 mm	12.7 mm	5 m	1.1274	0 960 316	7.30 €	
			150 mm	5 m	1.4310	0 960 334	78.55 €
	0,35 mm	12.7 mm	5 m	1.1274	0 960 317	8.30 €	
	0,40 mm	12.7 mm	5 m	1.1274	0 960 318	8.20 €	
	0,45 mm	12.7 mm	5 m	1.1274	0 960 319	8.30 €	
	0,50 mm	12.7 mm	5 m	1.1274	0 960 320	8.00 €	
	0,60 mm	12.7 mm	5 m	1.1274	0 960 321	12.55 €	
0,70 mm	12.7 mm	5 m	1.1274	0 960 322	12.65 €		
0,80 mm	12.7 mm	5 m	1.1274	0 960 323	12.75 €		
0,90 mm	12.7 mm	5 m	1.1274	0 960 324	13.35 €		
1,00 mm	12.7 mm	5 m	1.1274	0 960 325	13.35 €		

Precision gauge tapes

individual and as assortments with sheet sections

matching set

	Order No.	Price from 1 set
Reference sheet assortment, sheets 25 x 300 mm, contents: 21 pieces		
Contains 1 sheet each in the following thicknesses (in mm): 0.01 / 0.02 / 0.03 / 0.04 / 0.05 / 0.06 / 0.07 / 0.08 / 0.09 / 0.10 / 0.15 / 0.20 / 0.25 / 0.30 / 0.40 / 0.50 / 0.60 / 0.70 / 0.80 / 0.90 / 1.00	0 960 330	29.45 €
Reference sheet assortment, sheets 50 x 300 mm, contents: 25 pieces		
Contains 1 sheet each in the following thicknesses (in mm): 0.01 / 0.02 / 0.03 / 0.04 / 0.05 / 0.06 / 0.07 / 0.08 / 0.09 / 0.10 / 0.12 / 0.15 / 0.18 / 0.20 / 0.25 / 0.30 / 0.35 / 0.40 / 0.45 / 0.50 / 0.60 / 0.70 / 0.80 / 0.90 / 1.00	0 960 331	50.65 €

Accessories / spare parts

	Order No.	Price from 1 piece
Tin snips, straight (1 piece)		
 for cutting thin sheeting Length: 170 mm, cutting edge length: 50 mm	0 960 326	19.30 €



Assortment case

Raaco boxxser

Raaco boxxser assortment case

This handy case with a carrying handle and clever one-hand locking system can be divided using differently sized inserts. The inserts can be purchased individually or in six different set combinations. A grid in the lid and base of the case prevents the inserts from slipping.

Set A

S1	S1	S1	S1	S1
S2		S5	S5	S5
S2				
S4				S5
S4				

Set B

S1	S1	S1	S1	S1
S6	S6	S6	S6	S6

Set C

S2	S3
S2	S3
S2	S3
S2	S3
S2	S3

Set D

S1	S1	S3
S1	S1	S3
S1	S1	S3
S1	S1	S3
S2		S3
S2		S3

Set E

S1	S1	S3
S1	S1	S3
S1	S1	S3
S1	S1	S3
S1	S1	S3
S1	S1	S3







Set F

S1	S4
S5	S4
S5	S4
S5	S4
S5	S4

	Order No.	Price from
Assortment case	0 960 200	29.85 €



Case inserts set (without case!)

	Type	Packing quantity	Order No.	Price from
				1 set
Case inserts set				
	5 x S1, 2 x S2, 2 x S4, 4 x S5	A	13 piece	0 960 230 14.15 €
	5 x S1, 5 x S6	B	10 pieces	0 960 231 15.40 €
	5 x S2, 5 x S3	C	10 pieces	0 960 232 13.85 €
	6 x S1, 2 x S2, 5 x S3	D	13 piece	0 960 233 14.40 €
	10 x S1, 5 x S3	E	15 pieces	0 960 234 14.60 €
	1 x S1, 5 x S4, 2 x S5	F	7 piece	0 960 235 13.25 €

Assortment case Raaco boxxser

⚙️ Accessories / spare parts

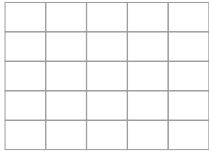

The case can be subdivided internally with inserts by means of a grid system (5 x 5 fields). Each grid has a dimension of 39 x 54 mm (D x W).

Overall internal case dimensions:

Depth: 5 x 39 mm (195 mm)

Width: 5 x 54 mm (270 mm)







	Type	Dimensions	Order No.	Price from 1 piece
Case inserts				
	S1	47 x 54 x 39 mm	0 960 221	0.50 €
	S2	47 x 108 x 39 mm	0 960 222	0.85 €
	S3	47 x 162 x 39 mm	0 960 223	1.22 €
	S4	47 x 216 x 39 mm	0 960 224	1.49 €
	S5	47 x 54 x 78 mm	0 960 225	0.85 €
	S6	47 x 54 x 156 mm	0 960 226	1.49 €



Illustration incl. optional inserts

Hard-wearing: the assortment case can take some punishment

Assortment case

Drawer cabinet

High-quality cabinet for neat storage and sorting of small components. Available with 28 drawers or alternatively with 24 extra deep drawers for large components. The drawers can be additionally subdivided by partitions and clearly labelled.

	Order No.	Price from 1 piece
Cabinet (28 drawers)		
 <p>24 drawers T1 (36 x 67 x 136 mm) 3 drawers T2 (64 x 91 x 136 mm) 1 drawer T3 (64 x 279 x 136 mm) Dimensions(H x W x D) 417 x 306 x 150 mm</p>	0 960 240	59.90 €

Accessories / spare parts

	Dimensions	Packing quantity	Order No.	Price from 1 set
Partitions, crossways for T1 (48 pieces)				
	35 x 64 x 2 mm	48 piece	0 960 241	7.60 €
Labels for T1 (48 pieces)				
	10 x 64 x 1 mm	48 piece	0 960 242	8.20 €

	Order No.	Price from 1 piece
Cabinet, extra deep (24 drawers)		
 <p>24 drawers T4 (53 x 80 x 225 mm) Dimensions (H x W x D) 435 x 357 x 255 mm</p>	0 960 250	106.00 €

Accessories / spare parts

	Dimensions	Packing quantity	Order No.	Price from 1 set
Partitions, crossways for T4 (36 pieces)				
	45 x 75 x 3 mm	36 piece	0 960 251	7.90 €
Labels for T4 (24 pieces)				
	15 x 75 x 1 mm	48 piece	0 960 252	4.46 €

Compressed-air aerosol refillable

Compressed air aerosol



Using this refillable aerosol, most liquid materials can be processed (ideal for spray-on oils, cleaners or cooling lubricants). This saves you a good deal of packaging waste and various different active substances can be economically refilled from large containers. Handling is child's play: the material is filled into the aerosol from above and charging with compressed air is performed through the base valve by means of the matching compressed air service station (optimum operating pressure 5–10 bars). Only the pure active ingredient and no compressed air is sprayed during use!



	Order No.	Price from 1 piece
Compressed-air aerosol		
Filling quantity: 400 ml, refillable from above, compressed-air filling viabase valve and the matching compressed-air service station, supplied incl. 2 valves and 4 spray heads	0 960 610	40.20 €



⚙️ Accessories / spare parts

	Order No.	Price from 1 piece	1 set
Compressed-air service station			
 for direct connection to the compressed-air network by means of a push-fit nipple, hose length approx. 0.5 m. For filling, the compressed-air aerosol is pushed into the service station. After the filling operation (approx. 8–10 seconds), the valve closes automatically. The service station can remain on the compressed-air network.	0 960 611	35.90 €	
Spray head valve set			
 consisting of four different spray heads and a ball valve with a suction tube	0 960 615	6.45 €	

Hand protection



Tubular knitted cotton gloves with micro-nubs

- Ultrafine cotton with micro-nubs
- Very thin and breathable
- Lint-free
- Good grip owing to vinyl micro-nubs
- Readily adapts to the hand
- Non-reversible

Material, LINER: 100 % cotton with vinyl nubs

	Size	Packing quantity	Order No.	Price from 1 pair
Tubular knitted cotton gloves with micro-nubs	10	12 pair	0 960 704	1.24 €



Latex + nitrile disposable gloves

Non-powdered gloves in a practical dispensing box (contains 100). Both materials offer extremely good sense of touch combined with flexibility and wearing comfort. The nitrile gloves are not only antiallergic, but also markedly more robust (puncture and tear-resistant) than those made of latex. They furthermore offer protection against solvents, bacteria, paints, alkalis, acids, oils, greases and many chemicals.

	Size	Packing quantity	Order No.	Price from 1 pack
Latex + nitrile disposable gloves	L	100 pieces	0 960 706	9.80 €
	XL	100 pieces	0 960 707	9.80 €



Maxi-Hit all-round gloves

- Nitrile Foam Technology (NFT) makes these gloves an "all-rounder":
- Abrasion-resistant, pleasant, flexible and breathable
- Liquid repellent
- Hard wearing and sensitive
- Back of hand made of Spandex liner for high stretchability and rapid drying

Material, LINER: 96 % nylon, 4 % elastane with (NFT) nitrile coating

	Size	Packing quantity	Order No.	Price from 1 pair
Maxi-Hit all-round gloves	10	12 pair	0 960 701	2.50 €
	9	12 pair	0 960 701-9	2.50 €

Hand protection



Gloves with PU fingertips

- Fingertips with PU coating on fine nylon liner
- Pleasant to wear
- Grip only in the fingertips
- Exact fit
- Lint-free
- Welded in pairs

Material, LINER: 100 % nylon with PU coating

	Size	Packing quantity	Order No.	Price from 1 pair
Gloves with PU fingertips	10	12 pair	0 960 703	0.92 €



Nubbed thermal assembly gloves

- Heat-resistant up to 150 °C
- Abrasion-resistant, sensitive, breathable
- Highly adaptable fit owing to stretchability

Material, LINER: 100 % polyacryl liner with foam nitrile

	Size	Packing quantity	Order No.	Price from 1 pair
Nubbed thermal assembly gloves	9	12 pair	0 960 705	3.27 €



Ultra Lite PU Hyflex gloves

- Hard wearing fine knitted nylon with supersoft PU coating
- Maximum wearing comfort and sense of touch
- Lint-free and breathable
- Super sensitive and highly flexible
- Exact fit and adaptability
- No fingerprints
- Several times reusable

Material, LINER: 100 % nylon with PU coating

	Size	Packing quantity	Order No.	Price from 1 pair
Ultra Lite PU Hyflex gloves	10	12 pair	0 960 702	2.38 €
	9	12 pair	0 960 702-9	2.38 €

Suction unit

joke Suction units

... Laser emissions, dust and fine particles, solvents, adhesive vapour, solder vapour/ welding vapour ...

at least one of these or some other pollutions also occur daily in your working environment. You should do something about them in order to avoid damage to health.

With a suction unit from joke, you create the optimum conditions for "good air" at the workplace – even if you ever "let it fly".

With us, you have a choice between two suction systems:

- **JF Compact** with favourably priced entrylevel products
- **AFD Premium** as a highly efficient system with comprehensive equipment details (high filter capacity, filter monitoring, serial interface for remote control)

Both systems can be configured with two filter modules. Suspended matter filter for dusts/fine particles and all particles that arise in mechanical processing sequences.

The activated charcoal filter is used wherever solvents, adhesive vapours, soldering vapour, smoke and similar gaseous pollutions arise. It eliminates or reduces them to a minimum.

Owing to the high density of the filters used, a very high level of separation of the particles and contaminants to be aspirated is achieved. The filters can be combined as individual modules and are easy to replace. Consequently, if replacement is required, you only actually need to change the saturated filter, whereas the remainder can continue to be used.

The turbine cooling (bypass cooling) inside the devices ensures very long services lives of the turbine units, even during constant use. The modular construction allows effective adaptation to individual requirements.

Suction arm for mounting on device

JF 5 Compact
Order No. 0 200 185

JF 10 Compact
Order No. 0 200 242-3

AFD Premium
Order No. 0 200 266

Suction hood
Order No. 0 200 248

Suction tube
Order No. 0 200 243

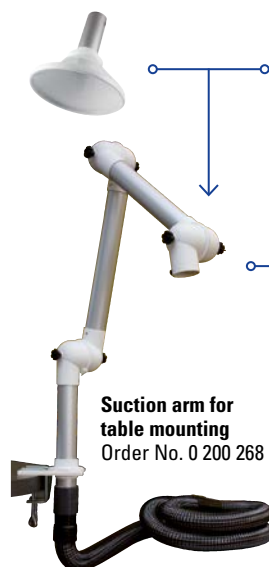

Suction arm for table mounting
Order No. 0 200 268



Suction unit
JF 5 Compact
Order No. 0 200 225
JF 10 Compact
Order No. 0 200 230-3
AFD Premium
Order No. 0 200 250-1



Things to know about contaminants at the workplace and use of suction units

Aerolsols consist of a large number of dust and smoke particles of different diameters. They occur during production processes such as milling, drilling, laser work, cutting, soldering and engraving, etc. The particle size is indicated in micrometres ($\mu\text{m} = 10^{-6}\text{m}$). Contamination of the respiratory tracts depending on the particle size is shown in the diagram opposite.

Maintenance intervals of the filters

With a properly dimensioned unit, the following intervals result for the individual filter types, depending on the contamination:

- Z-line filter: 4 – 8 months
- suspended matter filters: 4 – 8 months
- activated charcoal filters: 6 – 12 months

Without a change of filter, no protection of your health exists!

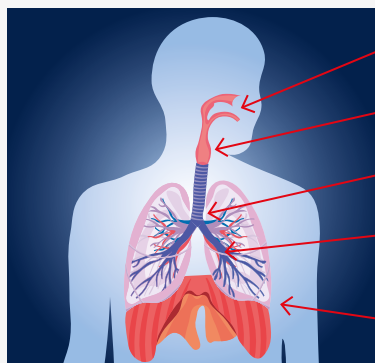



- Nasal mucosa and pharynx 10 μm
- Larynx 4,7 – 5,8 μm
- Trachea and main bronchi 3,3 – 4,7 μm
- Secondary and terminal bronchi 1,1 – 3,3 μm
- Alveoli 1 μm





Designed by Alvaro_cabrera/Freepik

Suction units

joke AFD Premium

		Design	Order No.	Price from 1 piece
Suction unit joke AFD Premium				
	Suction device with initial filter equipment and filter monitoring, continuously adjustable, operating hour counter, 4 castors for mobile use, without accessories		with suspended matter filter	0 200 250-1 2993.00 €
			with activated charcoal filter	0 200 250-ZA 3514.00 €
		Technical data: Suction capacity, free-blowing: 320 m ³ /h Suction capacity, effective: 50 – 250 m ³ /h Max. compression: 20,000 Pa Motor: constant running Connection: 100 – 240 V, 50/60 Hz Motor output: 1.1 kW Noise level: approx. 62 dB(A) Weight: approx. 40 kg (0200 250-1) approx. 55 kg (0 200 250-ZA)		
		Dimensions (W x H x D): 350 x 785 x 350 mm (with activated charcoal filter: 350 x 1,050 x 350 mm) Colour: RAL 7035 Suction connectors: 3 (rear) Suction connectors for arm: 1 (top) Filter equipment: Suspended matter filter H 13 2.4 m ² + z-line filter (Order No. 0 200 250-1) activated charcoal filter + suspended matter filter + z-line filter (Order No. 0 200 250-ZA)		

Accessories / spare parts



		Order No.	Price from 1 piece
Suspended matter filter, 300 x 300 x 78 mm			
		0 200 246	118.10 €
Z-line filter, 300 x 300 x 145 mm			
		0 200 245-N	212.00 €
Z-line-filter plus, 300 x 300 x 225 mm			
	for units built after 2017	0 200 245-3	194.00 €
Activated charcoal filter, 295 x 295 x 20 mm			
		0 200 240-1	341.00 €
Suction arm for mounting on device			
		850 mm long, 3 articulations, with damper cap, anodised aluminium tubes	0 200 266 368.00 €

Suction units

joke JF 10 Compact

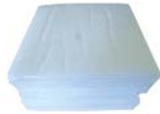

	Design	Order No.	Price from 1 piece
Suction unit joke JF 10 Compact			
	Suction device with initial filter equipment, infinitely adjustable, operating hour counter, 4 castors for mobile use, not including accessories	with suspended matter filter	0 200 230-3 1957.00 €
	<p>Technical data:</p> <p>Suction output, free blowing: 250 m³/h Effective suction output: 20 – 200 m³/h Max. compression: 6,000 Pa Motor: continuous running Connection: 120 – 230 V, 50/60 Hz Motor output: 0.65 kW Sound level: approx. < 62 dB(A) Weight: approx. 24 kg Dimensions (W x H x D): 300 x 510 x 300 mm Colour: RAL 7035 Suction connectors: 2 (rear) Suction connector for arm: 1 (top) Filter (0 200 230-3): Prefilter F5 + suspended particle filter H 13 Filter (0 200 230-ZA1): Prefilter F5 + suspended particle filter H 13 + activated charcoal filter</p>	with activated charcoal filter	0 200 230-ZA1 2163.00 €

Accessories / spare parts

	Order No.	Price from 1 piece
Suspended matter filter H 13, 250 x 250 x 190 mm		
	0 200 271	148.85 €
Filter mats F5, 230 x 230 mm (pack: 20 pieces)		
	0 200 257	44.90 €
Combination filter suspended matter/activated charcoal, 250 x 250 x 190 mm		
	0 200 240-4	359.00 €
Suction arm for mounting on device		
	850 mm long, 3 joints, without throttle valve, anodised aluminium tubes	0 200 242-3 294.00 €

Suction units

joke JF 5 Compact

	Design	Order No.	Price from 1 piece
Suction unit joke JF 5 Compact			
  <p>Suction device with initial filter equipment, continuously adjustable, operating hour counter, 4 device feet, without accessories</p> <p>Technical data: Suction capacity, free-blowing: 130 m³/h Suction capacity, effective: 20 – 100 m³/h Max. compression: 1,900 Pa Motor: constant running Connection: 90 – 264 V, 50/60 Hz Motor output: 0.05 kW Noise level: approx. 58 dB(A) Weight: approx. 17 kg Dimensions (W x H x D): 300 x 315 x 300 mm Colour: RAL 7035 Suction connectors: 2 (rear) Suction connectors for arm: optional Filter equipment: combination filter: suspended matter/activated charcoal filter (Order No. 0 200 227)</p>	with combined filter	0 200 225	1107.00 €

⚙️ Accessories / spare parts

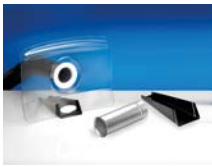
	Order No.	Price from 1 piece	1 set
Lid JF 5 with suction arm flex NW50			
 <p>Black, 900 mm, 2 articulations</p>	0 200 185	497.00 €	
Flat shield kit with table holder			
 <p>system 50, transparent, 330 x 240 mm, without suction hose</p>	0 200 152	205.00 €	
Hose set			
length 2.5 m, incl. connecting sleeve	0 200 153	43.70 €	



An electronic display opens up new possibilities!

- Filter monitoring
- Turbine monitoring
- Fault messages
- Speed control by tip function
- Clear and user-friendly visualisation of all data on a colour display

Suction units

Accessories

		Order No.	Price from 1 piece
Suction arm for table mounting			
	850 mm long, 3 joints, with throttle valve, anodised aluminium tubes, incl. table bracket and 2.5 m hose	0 200 268	426.00 €
Welding nozzle for suction arm			
	310 mm long, anodised aluminium	0 200 243	44.00 €
Suction shield for suction arm			
	Ø 200 mm	0 200 248	89.40 €
Connecting hose NW 44			
	2.5 m incl. 2 connecting sleeves	0 200 247	70.15 €
Suction funnel			
	incl. receptacle for LED protective pane <ul style="list-style-type: none"> • For tabletop thickness up to 60 mm • Suction opening 100 x 80 mm • Connection for rectangular tube 80 x 30 mm 	0 200 514	194.00 €
Suction duct			
	Rectangular tube 80 x 30 mm for suction funnel <ul style="list-style-type: none"> • Length 500 mm • For mounting under table • Suction connectors Ø 37/41mm 	0 200 515	67.10 €
Reducing sleeve 50/63 to 40/50			
	For connecting to the suction duct on connecting hose NW 44	0 200 251-3	25.65 €
LED protective pane			
	Optimum protection for your work <ul style="list-style-type: none"> • ESG protective pane • SMD-LED lighting (daylight white) • Extraction via suction funnel • Bright and shadow-free illumination • incl. table stand Technical data: Colour temperature: 6,000 K Luminosity: 2,500 Lux (brighter than two 60 W incandescent bulbs) Nominal voltage: AC 100–240 V, 50/60 Hz Operating voltage: 12 V Power consumption: 8 watts Dimensions, protective pane: height 205 mm, width 160 mm, thickness 4 mm	0 200 510	356.00 €



Deburring box JK15

NEW!

Deburring box JK15

The compact, semi-closed unit is designed for use during deburring, polishing and grinding work tasks on small workpieces. The deburring box is used among modellers and mould builders, jewellers, dental technicians, laboratory technicians, etc.

The lighted work chamber illuminated by a pivotable LED light has a compressed-air nozzle with variable air volume, which is adjustable by means of a ball joint. The air nozzle ensures that dust and dirt are directed away from the workpiece towards the suction nozzle. The unit has a connection for 4-mm compressed-air lines and a 4 mm to 6 mm adapter is also included in the scope of delivery.

At the rear, a suction unit can be connected to the exhaust air connector (Ø 57 mm) via a hose.

The polycarbonate shields can be folded open for easy cleaning of the box. The system is rounded off by the folding magnifier, a removable collecting tray and the padded armrests.

	Order No.	Price from 1 piece
Deburring box JK15		
 <p>with integrated LED lighting, padded armrests, air nozzle and magnifying glass attachment</p> <p>Technical data: Air nozzle: Air flow and position adjustable Air connection: Ø 4 / 6 mm at rear Magnifying glass: 2.5 x Ø 125 mm / 10 x Ø 25 mm Exhaust air connector: Ø 57 mm at rear Dimensions (W x D x H): 270 x 250 x 290 mm Supply voltage: 230 V, 50/60 Hz Weight: 5 kg</p>	0 200 896	490.00 €



Fig. air nozzle



Fig. rear connection

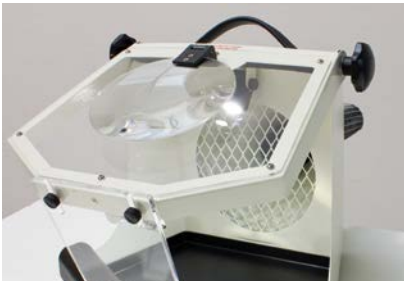



Microscopes and test devices

498 Stereomicroscopes

507 Cold light sources

505 Digital picture storage

510 Magnifying glasses

Stereomicroscopes

System overview SM-200 • SM-100 • SM-50

Stereomicroscope SM-200



SM-200 standard version
Order no. 0 200 600

SM-200 standard version with camera barrel
Order no. 0 200 600-1

- Rubber protectors**
Order no. 0 200 602
- Eyepiece 25 x**
Order no. 0 200 610
- Eyepiece 10 x**
Order no. 0 200 609
- LED ring light**
Order no. 200 621
- LED ring light with segment switching**
Order no. 200 623
- Lens 2,0 x**
Order no. 0 200 612
- Lens 0,5 x**
Order no. 0 200 611
- Neon ring light 8 W**
Order no. 0 200 613
- Spare neon bulb**
Order no. 0 200 61
- Digital video camera**
Order no. 0 200 631-2
Order no. 0 200 631-6

Stereomicroscope SM-100



SM-100 standard version
Order no. 0 200 600-3

- Digital video camera**
Order no. 0 200 631-2
Order no. 0 200 631-6
- C mount adapter 0,5 x for SM 100**
Order no. 0 200 698-1
- Rubber protectors**
Order no. 0 200 602
- Eyepiece 20 x**
Order no. 0 200 638
- Eyepiece 10 x**
Order no. 0 200 636
- Lens 2,0 x**
Order no. 0 200 642
- Lens 0,5 x**
Order no. 0 200 639

Stereomicroscope SM-500

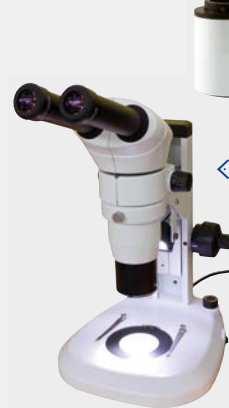

SM-500 standard version
Order no. 0 200 680

- Digital video camera**
Order no. 0 200 631-2
Order no. 0 200 631-6
- CCD adapter**
Order no. 0 200 686
- Beamsplitter**
Order no. 0 200 685
- Lens 0,5 x**
Order no. 0 200 681
Order no. 0 200 682

Stereomicroscopes

SM-100 • SM-200

Stereomicroscopes

Our stereomicroscopes are used to visually magnify workpieces or their surfaces for observation and inspection. Furthermore, tasks such as microwelding or polishing work can be monitored and checked in terms of quality directly at the workpiece. You have a choice between the introductory model SM-100 and the thousand times over tried and trusted top model SM-200 with versatile possibilities.

The structure of the stereomicroscopes with two eyepieces and one lens allows three-dimensional representation of the surface observed. Consequently, differences in height on the observation level can in particular be plastically detected.

Stereomicroscope SM-200

The stereomicroscope universally rotatable, pivotable and movable on columns can also be optimally erected over large workpieces without having to align the workpiece accordingly. The inspection area can be evenly illuminated by means of a ring light attachable to the lens. The working distance is increased to 160 mm when using a 0.5 x lens, which allows working under the microscope. The optimum magnification for the respective view can be configured using eyepieces and lenses with different magnifying factors.

Stereomicroscope SM-100

The little brother of the large microscope SM-200 is already equipped as standard with a camera barrel. Otherwise this microscope offers sophisticated technology too at an introductory price. The light can be switched separately with 3 versions: either only incident light or only transmitted light in addition to a combination of incident light and transmitted light.

The ideal basis for a digital image archiving environment: it is possible to switch over as desired from a stereo view through the eyepieces to camera deployment. In this case, the object is only still visible in one eyepiece. By substituting the glass plate supplied for the black/white working plate, it is also possible to observe objects with the transmitted light method.





	Stereomicroscopes SM-200	Stereomicroscopes SM-200 with camera barrel	Stereomicroscopes SM-100 with camera barrel
Foot plate dimensions	253 x 253 mm	253 x 253 mm	150 x 230 mm
Diopter	-3 bis +3 dpt	-3 bis +3 dpt	-3 bis +3 dpt
Magnification	3,25 to 225 x	3,25 to 225 x	5 to 200 x
Working distance	ca. 30 bis 150 mm	ca. 30 bis 150 mm	ca. 30 bis 150 mm
Dimensions	253 x 253 mm	253 x 253 mm	150 x 230 mm
Weight (kg)	25 kg	25 kg	5.5 kg
Travel	vert. 430 mm, horiz. 420 mm	vert. 430 mm, horiz. 420 mm	vert. 90 mm
Fine adjustment	vert. 66 mm, horiz. 57 mm	vert. 66 mm, horiz. 57 mm	vert. 66 mm
Scope of delivery	Basic device with 0.65 to 4.5 x magnification(continuously adjustable), 2 x eyepieces with 10 x magnification, lens protection cap, ring light (neon)	Basic device with 0.65 to 4.5 x magnification(continuously adjustable), 2 x eyepieces with 10 x magnification, lens protection cap, ring light (neon)	Basic device with 1.0 to 4.0 x magnification(continuously adjustable), 2 x eyepieces with 10 x magnification, working plate and glass plate, toggle between incident light and transmitted light
Order No.	0 200 600	0 200 600-1	0 200 600-3
Price	1,348.00 €	1,543.00 €	658.00 €

Stereomicroscopes

SM-100 • SM-200

Accessories / spare parts





	Packing quantity	SM-100	SM-200	Order No.	Price
Rubber protectors					
	2 pieces	•	•	0 200 602	7.05 €
Eyepiece 10 x					
	2 pieces		•	0 200 609	160.00 €
Eyepiece 25 x					
	2 pieces		•	0 200 610	196.00 €
Objectiv 0.5 x					
			•	0 200 611	160.00 €
Objectiv 2.0 x					
			•	0 200 612	175.00 €
Ring light, Neon ring light, 8 W					
 Fluorescent tube, 8 W, 220 V			•	0 200 613	160.00 €
Neon lamp					
			•	0 200 614	20.75 €
Eyepiece 10 x					
	2 pieces	•		0 200 636	53.65 €
Eyepiece 20 x					
	2 pieces	•		0 200 638	63.35 €
Lens 0.5 x					
		•		0 200 639	80.10 €
Lens 2.0 x					
		•		0 200 642	86.45 €
Transmitted light glass plate					
 Ø 95 mm		•		0 200 643	7.05 €

Premium stereo microscope SM-500

The binocular stereo zoom microscope SM-500 operates according to the CMO (Common Main Objective) principle, that is to say, 2 eyepieces jointly use a single lens, thereby achieving high optical quality. Equipped with an ergonomic stand including LED lighting. With a planachromatically corrected lens, it produces high-quality, best-resolution images for your high-tech applications. Its versatility and reliability make it suitable for use in industrial research & development in the workshop and laboratory. The stereo microscope SM-500 has a large zoom ratio of 1:10 and an 8 to 80x magnification range. First-rate optics offer the proper basis for ideal stereo viewing.

		Order No.	Price from 1 piece
Premium Stereo microscope SM-500			
	Magnification:	8 to 80 x	0 200 680 2540.00 €
	Working distance:	78 mm (126 mm with a 0.5x lens)	
	Travel:	vert. 105 mm	
	Fine adjustment:	vert. 1.5 mm per	
	Turn:	Diopter -3 to +3 dpt	
	Lighting:	Incident and transmitted LED lighting	
Scope of delivery:	20° binocular head, 1-x plan apochromatic objective, 2 x eyepiece with 10-x magnification, large ergonomic stand incl. LED lighting		

Accessories / spare parts

		Order No.	Price from 1 piece
Achromatic lens 0.5x for stereo microscope SM-500			
	Working distance ca. 126 mm	0 200 681	225.00 €
Planachromatic lens 0.5x for stereo microscope SM-500			
		0 200 682	486.00 €
Photo tube for stereo microscope SM-500			
		0 200 685	348.00 €
CCD adapter 1.0x for stereo microscope SM-500			
		0 200 686	32.00 €

Stereomicroscope LCD

LCD 100

Stereomicroscope LCD 100



The stereomicroscope is used to visually magnify workpieces or their surfaces for observation and inspection. Furthermore, tasks such as microwelding or polishing work can be monitored and checked in terms of quality directly at the workpiece.

The structure of the stereomicroscope with two eyepieces and one lens allows three-dimensional representation of the surface observed. Consequently, differences in height on the observation level can in particular be plastically detected.

The optimum magnification for the respective view can be configured using eyepieces and lenses with different magnifying factors.

		Order No.	Price from 1 piece
Stereomicroscope LCD 100, 8" LCD screen, incl. incident and reflected light, LED			
	Technical data:	0 200 665-2	1453.00 €
	Basic device, magnification (infinitely adjustable) 0.7 to 4.5 x		
	Travel:	vertical 150 mm	
	Fine adjustment:	vertical 50 mm	
	Optical magnification:	7 to 45 x (with 10 x eyepiece)	
	Working distance:	approx. 100 mm	
	Visible test surface:	max. Ø 28 mm	
	Eyepiece diopter:	-5 to +5 dpt	
	8" LCD screen:	800 x 600 pixels	
	CCD camera:	1/3" CCD camera 480 TV lines	
Illumination:	Incident and transmitted LED lighting		
Weight:	5 kg		
Scope of delivery:	Basic unit with 0.7 to 4.5x magnification (infinitely variable), 2 x eyepieces with 10 x magnification, 8" LCD monitor		

⚙️ Accessories / spare parts

		Order No.	Price from 1 piece	1 set
USB converter for stereomicroscope LCD 100, 8" LCD screen				
	For saving images via a USB connection to the PC.	0 200 673	337.00 €	
Rubber protectors				
		0 200 674		6.85 €
Lens 0.5x				
		0 200 669	161.00 €	

Stereomicroscope, view 0° straight with switchable magnetic base and flex arm

Stereomicroscope with switchable magnetic base and flex arm

The stand is equipped with a switchable magnetic base. Its high magnetic clamping force of 800N guarantees a secure hold. The large working distance allows comfortable work under the microscope. The 3-axis flex arm allows setting to any desired position.

		Order No.	Price from 1 piece
Stereomicroscope with switchable magnetic base and flex arm			
Magnification:	10/20 x	0 200 601-0	718.00 €
Eyepiece:	10 x		
View:	0°		
Working distance:	approx. 155/115 mm		
Magnetic base (W x L x H):	50 x 60 x 55 mm		
Magnetic force:	800 N		
Flex arm length L1/L2:	133/113 mm		
Scope of delivery:	including lens 1 x and lens 2 x		



Digital video camera for stereomicroscopes

Digital image archiving

The stereomicroscopes with a camera barrel are prepared for use with digital cameras.

Using the set of digital video camera and software, you can either cleanly archive the images or additionally process, measure and analyse etc. the latter using the special software. The camera is fitted to the camera barrel of the microscope using the C-mount adapter. The camera can also be installed on conventional microscopes without barrel using the adapter likewise supplied. It is installed in this case in front of the eyepieces of the microscope.

Both cameras can be connected to a PC via USB. The HD camera also enables you to observe brilliant images live on the screen via HDMI or save them on an SD card.

	Order No.	Price from 1 piece
Digital USB-2 camera with software		
 <p>Live transfer of your microscope results to your PC.</p> <p>0 200 631-2 498.00 €</p> <p>Technical data: Resolution: 5 megapixels (2.048 x 1.536 px) Connection: USB 2.0</p> <p>Scope of delivery:</p> <ul style="list-style-type: none"> • Image processing software • USB cable • 1/2" CMOS for installing the camera on microscopes using a C-mount adapter • incl. 2 eyepiece adapter Ø 30 and Ø 30,5 mm • Objectiv 0,45 x 5 fps (2.592 x 1.944 px) – 38 fps (640 x 480 px) • Calibration measuring plate 		

	Order No.	Price from 1 piece
Multiple HDMI/USB/SD-card microscope camera, HD-Ultra		
 <p>• Live via HDMI (1980 x 1080) 60 images per second • Live via USB/PC (1980 x 1080) 30 images per second • SD card recording format 1980 x 1080, video HD 980 x 1080</p> <p>Scope of supply:</p> <ul style="list-style-type: none"> • USB and HDMI cable • Stand-alone system, work without computer assistance possible • PC software • Onboard software / mouse control • Calibration measuring plate 	0 200 631-6	855.00 €



LED ring lights for stereomicroscopes

LED ring lights for stereomicroscopes

When working under a stereomicroscope, a good ring light is virtually part of the basic equipment, in order to guarantee correct illumination of the workplace and above all the object being viewed. Up to now, either neon lights or the professional variant cold lights have been used for this purpose. Thanks to ultra modern LED technology, there is now a great alternative: the new LED ring lights from joke. Owing to their LED's, these are not only brighter and more precise in illumination, they are also more economical and "live" longer.

Two versions of the LED ring lights are available. One with 48 LED's and adjustable luminous intensity. The other version has 60 LED's, switchable in 4 segments, with adjustable luminosity (not in segmental operation).

The ring lights are delivered completely ready to use with everything that you need to mount them on the microscope.



Use of the LED ring light with segmental switching on the SM-200 stereomicroscope.

		Order No.	Price from 1 piece
Ring light (48 LED's)			
	Working distance: 50 – 150 mm Internal: Ø 60 mm Colour temperature: 6,000 K Luminous intensity (adjustable): 12.000 Lux at 80 mm distance Bulb life: > 100,000 h Connection: 100 – 240 V, 50/60 Hz Output voltage: 24 V, DC, 250 mA Material: Housing made of robust plastic Scope of delivery: Power supply unit and connection cable	0 200 621	175.00 €

Model 1: ring light with 48 LED's.

		Order No.	Price from 1 piece
Ring light (60 LED's), individually switchable in 4 segments			
	Working distance: 50 – 150 mm Internal Ø: 60 mm Colour temperature: 6.500 K Luminous intensity (adjustable): 16.000 lux at 100 mm distance Bulb life: > 100,000 h Connection: 100 – 240 V, 50/60 Hz Output voltage: 12 V, DC, 400 mA Material: Housing made of aluminium Scope of delivery: Power supply unit and connection cable	0 200 623	244.00 €

Model 2: ring light with 60 LED's individually switchable in four segments (15 LED's respectively).

Cold light source P 100 W

Cold light source P 100 W

Powerful cold light source 100 watts of luminous power. Longlife illuminants as accessories are optionally available.

In this model, the brightness can be continuously adjusted by a rotary switch. The cold light sources are optionally available without, with a single swan-necked or double swannecked light guide.



		Design	Order No.	Price from 1 piece
Cold light source P 100 W				
Lamp:	Halogen 100 W, 12 V	without swan-necked light guide	0 200 710	372.00 €
Colour temperature:	3,200 K	with single swan-necked light guide, 53 cm	0 200 740	434.00 €
Bulb life:	approx. 50 h			
Light brightness:	by rotary switch			
Cooling:	by fan	with double swan-necked light guide, 53 cm	0 200 700	496.00 €
Dimensions (W x H x D):	approx. 110 x 155 x 240 mm			
Connection voltage:	230 V, 50/60 Hz			
Fuse:	1 A, slow blow			
Protection class:	IP 20			
Weight without light guide:	approx. 4 kg			
Weight with light guide:	approx. 4.4 kg			

Accessories / spare parts

		Order No.	Price from 1 piece
Illuminant, halogen 100 W			
		0 200 721	23.00 €
Illuminant, halogen 100 W, "Longlife" (approx. 1,500 h)			
	Lamp service life approx. 1,500 h, colour temperature 3,050 K	0 200 725	41.15 €
Single swan-necked light guide, 53 cm			
		0 200 730	116.75 €
Double swan-necked light guide, 53 cm			
		0 200 720	189.00 €
XXL Flexlight for cold light sources			
	For direct connection to our cold light sources. Delivery includes magnetic base for positioning on the workpiece in addition to two XXL swan necks (800 mm each) and flexible fibreglass supply lead (2,000 mm). Cold light source not included in scope of supply.	0 200 778	591.00 €
	Suitable light source:	0 200 745 and 0 200 710	



Cold light source ECO 20 W

Cold light sources

The cold light source is used for ultra-precise illumination of workpieces and surfaces etc. by means of the flexible fibreglass-filled light guides. The incident light does not generate any heat (= cold light) and its diffusion is absolutely uniform. This simultaneously prevents possible colour distortion of the objects observed. The self-supporting, flexible and rigid light guide allows the light to be aimed easily at the desired spot. The cold light lamp is used to facilitate optical inspection/control of workpieces/surfaces performed using microscopes, magnifying glasses, etc.

	Design	Order No.	Price from 1 piece
Cold light source ECO 20 W			
	Lamp: 20 W halogen, 12 V Colour temperature: 3,100 K Bulb life: approx. 4,000 h Light brightness: On/Off switch Cooling: none Dimensions (W x H x D): approx. 80 x 115 x 200 mm Connection voltage: 230 V, 50/60 Hz Fuse: 1 A slow-blow Protection class: IP 20 Weight without light guide: approx. 1.9 kg Weight with light guide: approx. 2.2 kg	ECO 20 W with single swan-necked light guide, 45 cm	0 200 750 282.00 €

⚙️ Accessories / spare parts



	Order No.	Price from 1 piece
Illuminant, halogen, 20 W	0 200 751	16.40 €
Single swan-necked light guide, 53 cm	0 200 730	116.75 €
		
Double swan-necked light guide, 53 cm	0 200 720	189.00 €
		



Cold light source LED

		Design	Order No.	Price from 1 piece
Cold light source LED, 30 W Power LED				
	Lamp:	Power-LED 30 W	30 W Power LED	0 200 745
	Colour temperature:	6,500 K		478.00 €
	Bulb life:	approx. 25,000 h		
	Light brightness:	by rotary switch		
	Cooling:	by fan		
	Connection voltage:	100 – 240 V, 50/60 Hz		
	Fuse:	1.25 A, slow-blow		
	Protection class:	IP 20		
	Swan-necked light not in delivery			

⚙️ Accessories / spare parts

	Order No.	Price from 1 piece
Single swan-necked light guide, 53 cm		
	0 200 730	116.75 €
Double swan-necked light guide, 53 cm		
	0 200 720	189.00 €
XXL Flexlight for cold light sources		
For direct connection to our cold light sources. Delivery includes magnetic base for positioning on the workpiece in addition to two XXL swan necks (800 mm each) and flexible fibreglass supply lead (2,000 mm). Cold light source not included in scope of supply.	0 200 778	591.00 €
Suitable light source: 0 200 745 and 0 200 710		

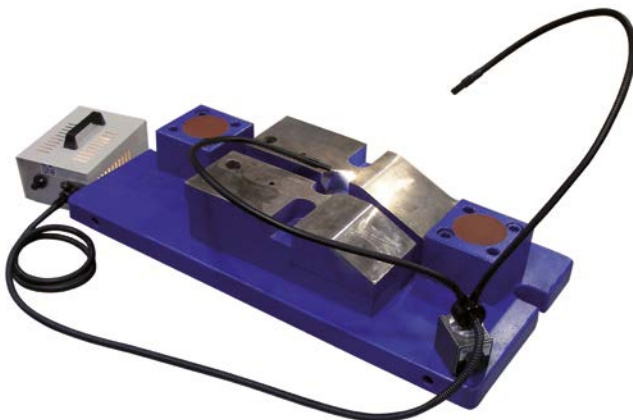

Magnifying spectacles

MD 2011

Magnifying spectacles MD 2011

Ergonomical, practical and good best sums up the magnifying spectacles MD 2011. They are extremely simple to use, not complicated adjustment to the wearer's own eyes is required. This is made possible by the wide pupillary distance (PD) range. The wide focussing range also allows good optical image quality. Owing to the adjustable sidepiece ends, the magnifying spectacles MD 2011 always fit perfectly without slipping. Also suitable for spectacle wearers, since the diopter compensation can be adjusted independently for the right and left side.

Applications:

- Model and mould building
- Quality control
- Watchmakers
- Restoration work
- Soldering workplaces
etc.

		Order No.	Price from 1 piece
Magnifying spectacles MD 2011		0 203 124	87.30 €
Magnification:	2 x		
Working distance:	ca. 400 mm		
PD range:	60 – 68 mm (PD = pupillary distance)		
Visual field:	10°, Ø 150 mm at 400 mm distance		
Diopter compensation:	± 3 dpt (right/left can be separately adjusted)		
Weight:	49 g		



⚙️ Accessories / spare parts

		Order No.	Price from 1 piece
LED spotlight for magnifying spectacles MD 2011, incl. power supply		0 203 121	98.30 €
Dimensions lamp:	32 x 20 x 34 mm, weight 11 g		
Dimensions battery housing:	90 x 55 x 40 mm, weight 60 g, without batteries		
Lighting intensity:	3200 lx in 250 mm, 1200 lx in 400 mm		
Light duration:	approx. 8 hours in normal mode, 14 hours in ecomode		
Cable length:	1 m		
Batteries:	3 x AA		
LED spotlight with clip for spectacle wearers, incl. power supply		0 203 122	118.35 €



LED spotlight with clip for spectacle wearers
(Order no. 0 203 122)



LED spotlight (Order no. 0 203 121)
Spectacles not included in scope of supply!

Binocular LED headband magnifying glass

Binocular LED headband magnifying glass

This magnifying glass with a triple LED unit illuminates the entire working area very uniformly.

The very light but nevertheless robust metal frame contains prismatic, metal-mounted silicate glass lenses. The optics are scratchproof, resistant to most chemicals and solvents and are characterised by a very high depth of field. Like the optics, the housing is also resistant to chemicals and solvents.

The magnifying glass can be easily worn over glasses.

	Order No.	Price from
		1 set
Binocular LED headband magnifying glass set		
	Triple LED unit (colour temperature 6,000 K) for optimum illumination of the working area.	0 200 569 170.00 €
	Magnification: 2 x, 2.5 x and 3 x Working distance: 220, 170 und 130 mm Weight: approx. 140 g Scope of supply: headband magnifying glass with LED, 3 exchangeable lenses as a set in a case	

Visor-type magnifying glass

Visor-type magnifying glass

Good things are sometimes as simple as this – and good value at the same time. This magnifying glass sits on your head like a baseball cap, leaving your hands free to do the work. The degree of magnification can be increased from 2 x to 3 x by simply adding another lens. When it is not needed, you can fold up the entire visor made of durable plastic, keeping the magnifying glass directly on your head for its next use.

	Order No.	Price from
		1 piece
Visor-type magnifying glass		
	Magnification range: 2 x or 3 x with additional fold-up additional lens Working distance: 450/340 mm Weight: approx. 100 g	0 200 590 22.70 €

Fold-away precision magnifying glass with leather storage case

LED precision magnifying glass

The handy magnifying glass with integrated LED ring lighting. The 6 LED's illuminate the working area without casting a shadow; the optics consisting of 3 glass lenses guarantee corrected colour errors and provide distortion-free images. Power supply by 3 x LR927 round cell batteries.

Lens	Magnification	Scope of delivery	Order No.	Price from 1 piece
LED precision magnifying glass				
Ø 21 mm glass	10 x	magnifying glass, batteries, case	0 200 538	23.00 €
	20 x	magnifying glass, batteries, case	0 200 528	23.00 €

ⓘ Replacement battery (Order no. 0 200 539) additionally available.

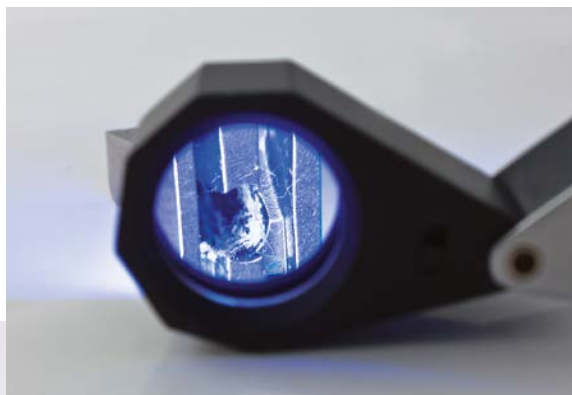

Watchmaker's magnifying glass

Watchmaker's magnifying glass

What's good enough for watchmakers is good enough for you: plastic casing, silicate glass lens. Available in three versions: 5 x / 7 x / 15 x magnification

	Ø lens	Magnification	Order No.	Price from 1 piece
Watchmaker's magnifying glass (Plastic frame)				
	Ø 30 mm	5 x	0 200 580	12.50 €
		7 x	0 200 581	20.00 €
	Ø 16.3 mm	15 x	0 200 582	24.55 €

Hand-held LED magnifiers

LED hand-held illuminated magnifying glass

The mobile hand-held illuminated magnifying glass with the latest lighting technology and ergonomic shape. Optimum illumination is achieved with the 2-stage boost switch and a light colour of 4,500 K. Includes batteries and microfibre bags for storage and cleaning.

	Ø lens	Magnification	Order No.	Price from 1 piece
Hand-held LED magnifiers				
	Ø 16.3 mm	15 x	0 200 589	79.55 €
	Ø 30 mm	8 x	0 200 588	79.85 €

Inspection light sticks Boride® Rib-Light

Inspection light sticks Boride® Rib-Light

The ideal lamp to light up hard to access places (ribs, bridges etc.). Handy like a ball point pen, you can be sure to find room in any shirt pocket. One push of the button is enough and the rib-lights deliver a very bright, precise light thanks to the LED technology. The lamps are available with and without swan necks.

	Design	Order No.	Price from 1 piece
Inspection light sticks Boride® Rib-Light			
	available with and without swan neck (190 mm long), stick length 155 mm, Ø 9 mm, white LED	with swan neck, white LED	0 200 595 42.55 €
		without swan neck, white LED	0 200 597 31.30 €

Inspection devices

514 Inspection system

520 WiFi /USB camera

521 Flexible endoscope



Inspection system 2500

System overview

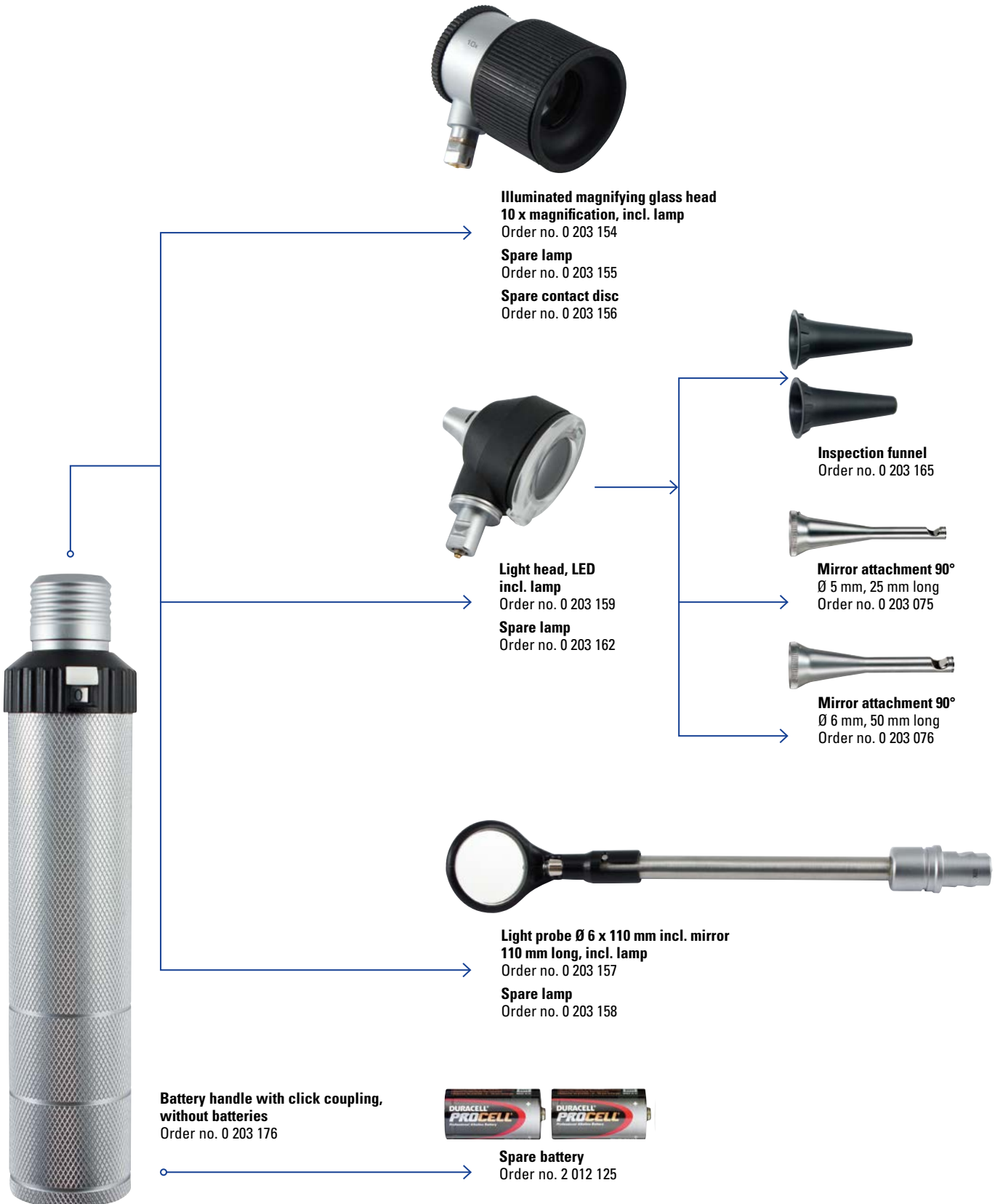



Inspection system 2500

Light head

Inspection system 2500

The modular system offers you a wide range of inspection possibilities. Simply changing the inspection heads using the automatic click coupling provides you the right equipment for any application. The robust metal handle is supplied by 2 batteries. The 2.5-volt system is equipped with a high-power xenon light or high quality LED technology. The devices are used for observing surfaces, bores and cavities, etc.

	Order No.	Price from 1 piece
Battery handle for 2 batteries		
 <ul style="list-style-type: none"> • with click-on connection • Ø 29 x 146 mm • 2.5 V • without batteries 	0 203 176	58.10 €

	Order No.	Price from 1 piece
Illuminated magnifying glass with 10 x magnification		
 <ul style="list-style-type: none"> • click-on connection • xenon/halogen bulb • 2.5 V • focus adjustment –6 up to +3.5 dpt • large contact disk (Ø 25 mm) with scale setting for the measurement • uniform, intensive illumination 	0 203 154	261.00 €

⚙️ Accessories / spare parts

	Order No.	Price from 1 piece
Spare lamp		
Spare lamp 2.5 V, for light head 10 x, System 2500	0 203 155	31.95 €
Spare contact disc		
Spare contact disc (Ø 25 mm) with scaling for measurement	0 203 156	37.60 €



	Order No.	Price from 1 piece
Light probe Ø 6 x 110 mm incl. mirror		
 <ul style="list-style-type: none"> • click coupling • xenon • 2.5 V 	0 203 157	34.00 €

⚙️ Accessories / spare parts



	Order No.	Price from 1 piece
Spare lamp 2.5 V, for light probe Ø 6 x 110 mm		
	0 203 158	16.10 €

Inspection system 2500

Light head

	Order No.	Price from
Light head		1 piece
 <ul style="list-style-type: none"> • click-on connection • LED bulb • illuminance approx. 8,000 Lux • lifetime approx. 100,000 h • pivoting magnifying glass with 3-fold magnification • direction of vision 0° and 90° with mirror attachment (see accessories) 	0 203 159	84.60 €

⚙️ Accessories / spare parts

	Dimensions	Order No.	Price from
Spare lamp for light head (2.5 V)			1 pack 1 piece
		0 203 162	24.95 €
Inspection funnel, 10 pieces			
	5 x Ø 2,5 x 35 mm and 5 x Ø 4 x 30 mm	0 203 165	6.95 €
Mirror attachment 90° for light head			
	Ø 5 x 25 mm	0 203 075	64.65 €
	Ø 6 x 50 mm	0 203 076	64.65 €



Functional principle

The light of a lens bulb ❶ is projected onto the end surface ❷ of a bundle of optical fibres ❸. Consisting of several thousand optical fibres. The fibres are arranged in a circle at the light emission point ❹.

In this way a uniform and shadowless coaxial illumination of the field of view is generated.

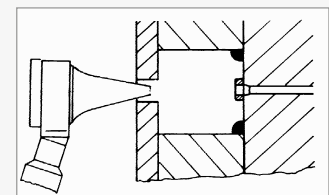
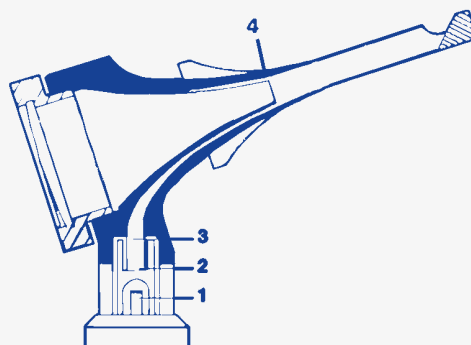

Viewing direction 0°

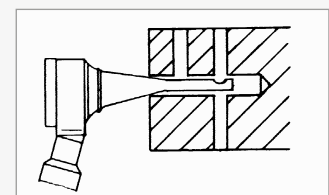



Viewing direction 90°

Light head Mini

lightweight, practical and universally usable

	Order No.	Price from 1 set
Set Light head, Mini 2.5 V, LED, F.O. fibre optics		
 <ul style="list-style-type: none"> • Fibre optic LED high power illumination • LED lamp life approx. 50,000 h • Illuminance approx. 18,000 lux (distance 15 cm) • Pivotal magnifying glass with 3 x magnification • Viewing direction 0° or 90° with mirror attachment <p>Scope of supply: Light attachment, battery handle for 2 x mignon type AA, without batteries, inspection funnel, pieces: 10 x Ø 2.5 x 35 mm and 10 x Ø 4 x 30 mm</p>	0 203 150	133.30 €

Accessories / spare parts

	Dimensions	Order No.	Price from 1 pack 1 piece
Spare lamp for light head (2.5 V)			
		0 203 151	59.05 €
Inspection funnel, 10 pieces			
	5 x Ø 2,5 x 35 mm and 5 x Ø 4 x 30 mm	0 203 165	6.95 €
			
Mirror attachment 90° for light head			
	Ø 5 x 25 mm	0 203 075	64.65 €
	Ø 6 x 50 mm	0 203 076	64.65 €

Cold light lamp Mini 3000

lightweight, practical and universally usable

Cold light source Mini 3000

A lightweight, practical and universally usable instrument for visual control with outstanding illumination.



- Light rod length 100 mm
- Ø 2.5 mm probes

Applications:

- Inspecting blind holes
- Narrow slots in mould making
- Controlling injection moulding tools incorporated in the machine
- General testing

	Design	Order No.	Price from 1 piece
	incl. battery handle and 2 AA batteries		
	Ø 2.5 x 100 mm	0 203 030-5	207.00 €
	Ø 5 x 100 mm	0 203 031-5	207.00 €

Accessories / spare parts

	Dimensions	Order No.	Price from 1 piece
Spare lamp 2.5 V, XHL®			
	suitable for Order No. 0 203 030-5 and 0 203 031-5	0 203 030-1	26.20 €
Glass mirror, clip-on			
	suitable for Order No. 0 203 031-5	Ø 25 mm	0 203 088
		Ø 16 mm	0 203 038
Steel mirror, clip-on			
	suitable for Order No. 0 203 031-5	Ø 8 mm	0 203 093
		Ø 12 mm	0 203 066

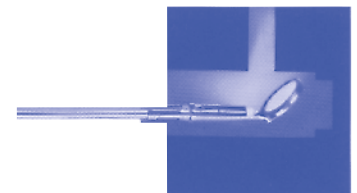
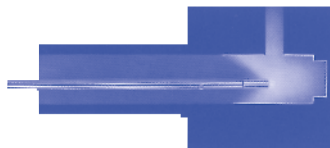

USB / WiFi Digital Microscope for iPhone / iPad / Android and PC

Simple installation – intuitive versatile use

Two clicks are all you need to connect the WiFi microscope to a smartphone or tablet (iOS, Android and Windows Mobile). Images and videos of the surfaces and details to be inspected can then be produced using an App. The device is used to monitor components in electronics and fine mechanics, such as PCBs or circuit boards, in toolmaking and mould building, in the textile industry and in medicine. In the case of videos, the findings can be immediately recorded on the PC via USB using the integrated microphone and the result can then be sent to colleagues by email or saved on the company network – diagnosis and quality assurance can be as easy as that. The images can be processed directly on the screen and archived using the software contained in the scope of delivery.

	Order No.	Price from 1 piece
WiFi / USB digital microscope for iPhone / iPad / Android / PC		
	0 200 687 Magnification: 12 – 65 x Resolution: 5 megapixels, max. 2,592 x 1,944 pixels Weight: 100 g Scope of delivery: Microscope with LED lighting, USB cable, rechargeable lithium battery, external DC 5V, DC 5V, 1.5 A adapter, installation CD	344.00 €

Accessories / spare parts

	Order No.	Price from 1 piece
Mounting for WiFi microscope, with switchable magnetic foot and flexible arm		
	0 200 690 Flexible arm with 3 joints. Can be flexibly positioned by means of a switchable magnetic foot. This even allows work against the force of gravity. Max. retention force of the magnet approx. 80 kg. Total height 340 mm	104.45 €



Flexible endoscope display unit

3.5" HD digital

Flexible endoscope display unit	Order No.	Price from	
		1 piece	
 <ul style="list-style-type: none"> • Integrated 3.5" LCD screen • Data transferable in HD digital format • Resolution 720 x 640 px • 8-position digital zoom • TV/AV connection (PAL/NTSC) • Infinitely adjustable LED light • USB 1.0 and 2.0 port • Selection of 17 different menu languages • SD memory card slot • Acquisition of images and videos • Impact-proofed housing • Storage battery life 440 minutes <p>Scope of supply: Impact-proofed carrying case, 3.7 V power supply unit, 4 GB SD card, USB cable, cleaning set, operating instructions</p>	0 203 270	598.00 €	

⚙️ Accessories / spare parts



	Order No.	Price from	
		1 piece	1 set
Endoscope probe, Ø 3.9 mm, 1,000 mm long  <p>Resolution: 300,000 pixels Luminosity: 1,200 lux</p>	0 203 279	491.00 €	
Endoscope probe, Ø 4.3 mm, 1,000 mm long  <p>Resolution: 300,000 pixels Luminosity: 1,300 lux</p>	0 203 276	415.00 €	
Mirror set  <p>In three parts, Ø 4.3 mm, 35–70°, 45–90°, 55–120°</p>	0 203 278	116.25 €	



Fig.: Corrosion in the cooling duct